

**GMC**

# HUMMER EV

OWNER'S MANUAL

2023



## Contents

Introduction .....	1
Keys, Doors, and Windows .....	6
Seats and Restraints .....	37
Storage .....	82
Instruments and Controls .....	86
Lighting .....	122
Infotainment System .....	129
Climate Controls .....	156
Driving and Operating .....	161
Vehicle Care .....	290
Service and Maintenance .....	358
Technical Data .....	364
Customer Information .....	366
Reporting Safety Defects .....	374
OnStar .....	378
Connected Services .....	383
Index .....	386

Litho in U.S.A.  
Part No. 84867426 A First Printing

## Introduction California Proposition 65 Warning



# WARNING

**Operating, servicing and maintaining a passenger vehicle or off-highway motor vehicle can expose you to chemicals including engine exhaust, carbon monoxide, phthalates, and lead, which are known to the State of California to cause cancer and birth defects or other reproductive harm. To minimize exposure, avoid breathing exhaust, do not idle engine except as necessary, service your vehicle in a well-ventilated area and wear gloves or wash your hands frequently when servicing your vehicle. For more information go to [www.P65Warnings.ca.gov/passenger-vehicle](http://www.P65Warnings.ca.gov/passenger-vehicle).**

©2022 General Motors LLC. All Rights Reserved.

### Introduction



The names, logos, emblems, slogans, vehicle model names, and vehicle body designs appearing in this manual including, but not limited to, GM, the GM logo, GMC, the GMC Truck Emblem, and HUMMER are trademarks and/or service marks of General Motors LLC, its subsidiaries, affiliates, or licensors.

For vehicles first sold in Canada, substitute the name “General Motors of Canada Company” for GMC wherever it appears in this manual.

This manual describes features that may or may not be on the vehicle because of optional equipment that was not purchased on the vehicle, model variants, country specifications, features/applications that may not be available in your region, or changes subsequent to the writing of this owner’s manual, including changes in standard or optional content.

Refer to the purchase documentation relating to your specific vehicle to confirm the features.

### Canadian Vehicle Owners

A French language manual can be obtained from your dealer, at [www.helminc.com](http://www.helminc.com), or from:

#### Propriétaires Canadiens

On peut obtenir un exemplaire de ce guide en français auprès du concessionnaire ou à l'adresse suivante:

Helm, Incorporated  
Attention: Customer Service  
47911 Halyard Drive  
Plymouth, MI 48170  
USA

### Danger, Warning, and Caution

Warning messages found on vehicle labels and in this manual describe hazards and what to do to avoid or reduce them.



**Danger**

Danger indicates a hazard with a high level of risk which will result in serious injury or death.

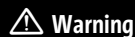

**Warning**

Warning indicates a hazard that could result in injury or death.

**Caution**

Caution indicates a hazard that could result in property or vehicle damage.





A circle with a slash through it is a safety symbol which means “Do not,” “Do not do this,” or “Do not let this happen.”

### Symbols

The vehicle has components and labels that use symbols instead of text. Symbols are shown along with the text describing the operation or information relating to a specific component, control, message, gauge, or indicator.

 : Shown when the owner's manual has additional instructions or information.

 : Shown when the service manual has additional instructions or information.

 : Shown when there is more information on another page — “see page.”

### Vehicle Symbol Chart

Here are some additional symbols that may be found on the vehicle and what they mean. See the features throughout the owner's manual for more information.

 : Air Conditioning System

 : Air Conditioning Refrigerant Oil

 : Airbag Readiness Light

 : Antilock Brake System (ABS)

 : Brake System Warning Light

 : Dispose of Used Components Properly

 : Do Not Apply High Pressure Water

 : Energy Usage and Charge Mode Selection

 : Flame/Fire Prohibited

 : Flammable

 : First Responder

 : Forward Collision Alert

 : Fuse Block Cover Lock Location

 : Fuses

 : High Voltage

 : ISOFIX/LATCH System Child Restraints

 : Keep Fuse Block Covers Properly Installed

 : Lane Change Alert

 : Lane Departure Warning

 : Lane Keep Assist

 : Park Assist

 : Pedestrian Ahead Indicator

 : Power

 : Rear Cross Traffic Alert

 : Registered Technician

 : Remote Vehicle Start

 : Risk of Electrical Fire

 : Seat Belt Reminders

 : Service Vehicle Soon

 : Side Blind Zone Alert

 : Tire Pressure Monitor

 : Traction Control/StabiliTrak/Electronic Stability Control (ESC)

 : Under Pressure

 : Vehicle Ahead Indicator

 : Vehicle Ready



## Instrument Panel Overview

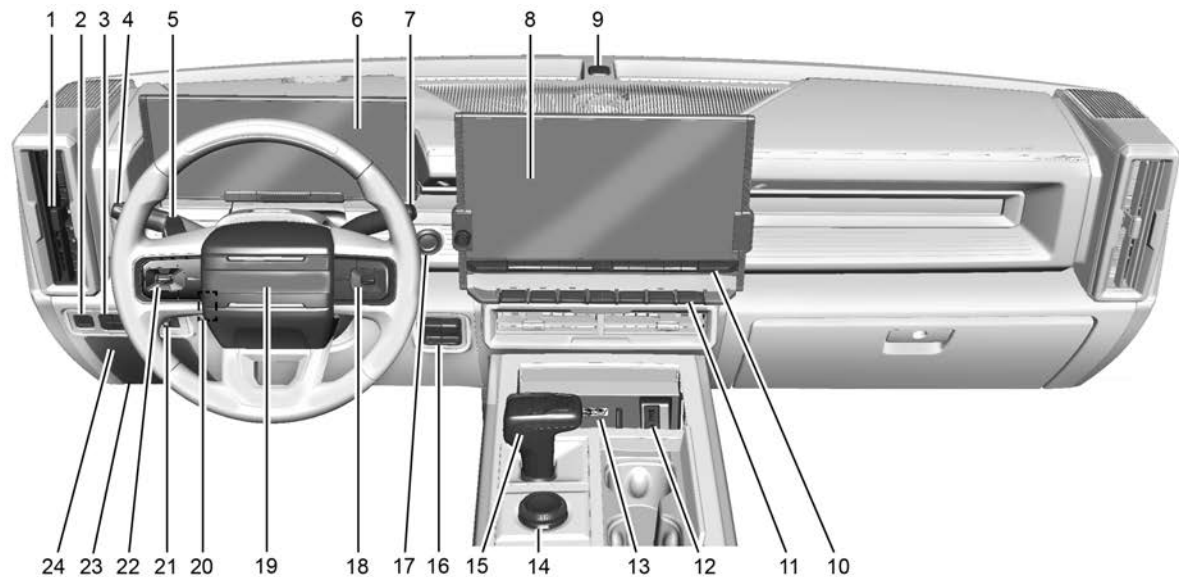

1. *Air Vents* ⇨ 159.
2. *Electric Parking Brake* ⇨ 189.
3. *Underhood Storage (eTrunk™)* ⇨ 83.  
*Power Release Tailgate (If Equipped). See Tailgate* ⇨ 19.  
*Lane Keep Assist (LKA)* ⇨ 250 (If Equipped).  
*Express Window Down Button (If Equipped). See Power Windows* ⇨ 29.  
*Exterior Cargo Lamps* ⇨ 125 (If Equipped).  
*110V Power Outlet Enable (If Equipped). See Power Outlets* ⇨ 89.
4. *Turn Signal Lever. See Turn and Lane-Change Signals* ⇨ 125.  
*Exterior Lamp Controls* ⇨ 122.
5. *Regenerative Braking* ⇨ 190.
6. *Instrument Cluster* ⇨ 94.
7. *Windshield Wiper/Washer* ⇨ 88.
8. *Infotainment. See Introduction* ⇨ 129.
9. *Light Sensor. See Automatic Headlamp System* ⇨ 124.
10. *Dual Automatic Climate Control System* ⇨ 156.  
*Heated and Ventilated Front Seats* ⇨ 43 (If Equipped).
11. *Heated Steering Wheel* ⇨ 87.  
*Locking Rear Axle* ⇨ 199.  
*Locking Front Axle* ⇨ 200.  
*Hazard Warning Flashers* ⇨ 125.  
*Traction Control/Electronic Stability Control* ⇨ 191.  
*Park Assist* ⇨ 237.  
*Automatic Parking Assist (APA)* ⇨ 238.
12. *USB Port* ⇨ 136.
13. *Wireless Charging* ⇨ 91.
14. *Driver Mode Control* ⇨ 194.
15. *Shift Lever. See Electric Drive Unit* ⇨ 184.
16. *Trailer Brake Control Panel (If Equipped). See Towing Equipment* ⇨ 270.
17. *Power Button* ⇨ 180.
18. *Steering Wheel Controls* ⇨ 130.
19. *Horn* ⇨ 87.
20. *Steering Wheel Adjustment* ⇨ 87.
21. *Dimmer Switch. See Instrument Panel Illumination Control* ⇨ 126.
22. *Super Cruise* ⇨ 213 (If Equipped).  
*Adaptive Cruise Control (Advanced)* ⇨ 203 (If Equipped).  
*Forward Collision Alert (FCA) System* ⇨ 243 (If Equipped).
23. *Hood Release. See Hood* ⇨ 292.
24. *Instrument Panel Fuse Block (Right)* ⇨ 312 or *Instrument Panel Fuse Block (Left)* ⇨ 310.

## Keys, Doors, and Windows

### Keys and Locks

Keys .....	6
Remote Key .....	7
Remote Key Operation .....	7
Remote Vehicle Start .....	12
Door Locks .....	13
Power Door Locks .....	14
Delayed Locking .....	14
Automatic Door Locks .....	15
Lockout Protection .....	15
Safety Locks .....	15
Digital Key .....	16

### Doors

Hood .....	16
Tailgate .....	19

### Vehicle Security

Vehicle Security .....	22
Vehicle Alarm System .....	23
Steering Column Lock .....	23
Immobilizer .....	24
Immobilizer Operation .....	24

### Exterior Mirrors

Power Mirrors .....	25
Folding Mirrors .....	25

Heated Mirrors .....	26
Automatic Dimming Mirror .....	26
Reverse Tilt Mirrors .....	26

### Interior Mirrors

Interior Rearview Mirrors .....	26
Automatic Dimming Rearview Mirror ...	27
Rear Camera Mirror .....	27

### Windows

Windows .....	29
Power Windows .....	29
Rear Windows .....	30
Sun Visors .....	31

### Roof

Roof Panel .....	31
------------------	----

## Keys and Locks

### Keys



#### Warning

Leaving children in a vehicle with a remote key is dangerous and children or others could be seriously injured or killed. They could operate the power windows or other controls or make the vehicle move. The windows will function with the remote key in the vehicle, and children or others could be caught in the path of a closing window. Do not leave children in a vehicle with a remote key.





The mechanical key inside the remote key is used for the driver door and glove box.

To remove the mechanical key, press the button on the side of the remote key near the bottom, and pull the mechanical key out. Never pull the mechanical key out without pressing the button.

The mechanical key may have a bar-coded key tag that the dealer or qualified locksmith can use to make new keys. Store this information in a safe place, not in the vehicle.

See your dealer if a replacement key or additional key is needed.

If it becomes difficult to turn a key, inspect the key blade for debris. Periodically clean with a brush or pick.

With an active OnStar or connected service plan, an OnStar Advisor may remotely unlock the vehicle. See *OnStar Overview* ⇨ 378.

If locked out of the vehicle, see *Roadside Assistance Program* ⇨ 369.

If equipped with memory seats, remote keys 1 and 2 are linked to seating positions of memory 1 or 2. See *Memory Seats* ⇨ 40.

## Remote Key

See *Radio Frequency Statement* ⇨ 374.

If there is a decrease in the remote key operating range:

- Check the distance. The remote key may be too far from the vehicle.
- Check the location. Other vehicles or objects may be blocking the signal.
- Check the remote key's battery. See "Battery Replacement" under *Remote Key Operation* ⇨ 7.
- If the remote key is still not working correctly, see your dealer or a qualified technician for service.

## Remote Key Operation

The Keyless Access system allows for vehicle entry when the remote key is within 1 m (3 ft). See "Keyless Access Operation" later in this section.

The remote key functions may work up to 60 m (197 ft) away from the vehicle.

Other conditions can affect the performance of the remote key. See *Remote Key* ⇨ 7.



**L** : Press to lock all doors.



If enabled, the turn signal lamps flash once on the second press to indicate locking has occurred. If enabled, the horn chirps when



**L** is pressed again within three seconds. To

## 8 Keys, Doors, and Windows

view available settings from the infotainment screen, touch Settings > Vehicle > Remote Lock, Unlock, Start.

Pressing  arms the alarm system. See *Vehicle Alarm System* ⇨ 23.

With power folding mirrors, double pressing and holding  for one second will fold the mirrors, if enabled. Double press and hold  for one second to unfold the mirrors. To view available settings from the infotainment screen, touch Settings > Vehicle > Comfort and Convenience.

 : Press once to unlock only the driver door. If  is pressed again within three seconds, all remaining doors unlock. The interior lamps may come on and stay on for 20 seconds or until the vehicle is started.

If enabled, the turn signal lamps flash twice to indicate unlocking has occurred. If enabled, the exterior lamps may turn on. To view available settings from the infotainment screen, touch Settings > Vehicle > Remote Lock, Unlock, Start.



Pressing  on the remote key disarms the alarm system. See *Vehicle Alarm System* ⇨ 23.



Double press and hold  until the windows fully open, if remote window operation is enabled. To view available settings from the infotainment screen, touch Settings > Vehicle > Remote Lock, Unlock, Start.

 : Press twice to open the tailgate. The vehicle must be in P (park).

 : Press twice to open the hood. Press twice and hold to close the hood. In order to open or close remote key must be within 30m (100ft). The vehicle must be in P (park).

 : Press and release to initiate vehicle locate. The turn signal lamps flash and the horn sounds three times.

Press and hold  for more than three seconds to activate the panic alarm. The turn signal lamps flash and the horn sounds repeatedly for 30 seconds. The alarm turns off when the vehicle is turned on or  is pressed again. The vehicle must be off for the panic alarm to work.

 : Press  twice from outside the vehicle to remote start the vehicle. The vehicle cannot be started if a remote key is left inside the vehicle. See *Remote Vehicle Start* ⇨ 12.

### Keyless Access Operation

The Keyless Access system allows for doors, tailgate, and hood to be accessed without removing the remote key or digital key from your pocket, purse, briefcase, etc. The remote key or digital key must be within 1 m (3 ft) of the tailgate, hood, or door being opened. If the vehicle has this feature, there will be a button on the outside door handles.

Keyless Access can be programmed to unlock all doors on the first lock/unlock press from the driver door. To view available settings from the infotainment screen, touch Settings > Vehicle > Remote Lock, Unlock, Start.

Remote keys 1 and 2 are linked to seating positions of memory 1 or 2. See *Memory Seats* ⇨ 40.

### Keyless Unlocking/Locking from the Driver Door

When the doors are locked and the remote key or digital key is within 1 m (3 ft) of the door handle, pressing the lock/unlock button on the driver door handle will unlock the driver door. If the lock/unlock button is pressed again within five seconds, the doors, tailgate, and hood will unlock.

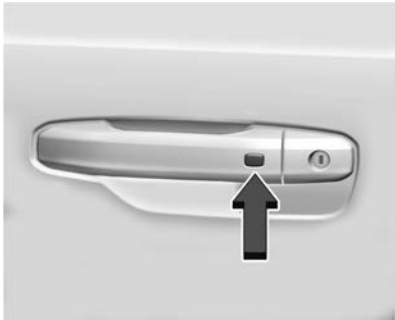

Driver Side Shown, Passenger Side Similar

Pressing the lock/unlock button will cause all doors to lock if any of the following occur:

- It has been more than five seconds since the first lock/unlock button press.
- Two lock/unlock button presses were used to unlock all doors.
- Any vehicle door has been opened and all doors are now closed.

#### Keyless Unlocking/Locking from the Passenger Doors

When the doors are locked and the remote key or digital key is within 1 m (3 ft) of the door handle, pressing the lock/unlock button on a passenger door handle will unlock all



doors. Pressing the lock/unlock button will cause all doors to lock if any of the following occur:

- The lock/unlock button was used to unlock all doors.
- Any vehicle door has been opened and all doors are now closed.



#### Disable/Enable Keyless Unlocking of Exterior Door Handles, Tailgate, and Hood

Keyless unlocking of the exterior door handles, tailgate, and hood can be disabled and enabled.

#### Disabling Keyless Unlocking:

With the vehicle off, press and hold  and  on the remote key at the same time for approximately three seconds. The turn signal lamps will flash four times quickly to indicate access is disabled. Using any exterior handle to unlock the doors, open the tailgate, or open the hood will cause the turn signal lamps to flash four times quickly, indicating access is disabled. If disabled, disarm the alarm system before starting the vehicle.

#### Enabling Keyless Unlocking:

With the vehicle off, press and hold  and  on the remote key at the same time for approximately three seconds. The turn signal lamps will flash twice quickly to indicate access is enabled.

To view available settings from the infotainment screen, touch Settings > Vehicle > Remote Lock, Unlock, Start.

#### Passive Locking

The Keyless Access system will lock the vehicle several seconds after all doors are closed, if the vehicle is off and at least one remote key or digital key has been removed from the interior, or none remain in the interior.

If other electronic devices interfere with the remote key or digital key signal, the vehicle may not detect the remote key or digital key inside the vehicle. If passive locking is enabled, the doors may lock with the remote key or digital key inside the vehicle. Do not leave the remote key or digital key in an unattended vehicle.



If the vehicle is locked with a remote key inside the vehicle, that remote key will be disabled from starting the vehicle and other

keyless access operations. To re-enable the remote key, press any button on the remote key. The remote key will also be re-enabled when the vehicle is started with another known remote key, or when the vehicle is unlocked.

To view available settings from the infotainment screen, touch Settings > Vehicle > Remote Lock, Unlock, Start.

If equipped with remote folding mirrors, passive locking may fold and unfold the mirrors see *Folding Mirrors* ⇨ 25.

### Temporary Disable of Passive Locking

Temporarily disable passive locking by pressing and holding  on the interior door switch with a door open for at least four seconds, or until three chimes are heard. Passive locking will then remain disabled until  on the interior door is pressed, or until the vehicle is turned on.

### Remote Left In Vehicle Alert

When the vehicle is turned off and a remote key or digital key is left in the vehicle, the horn will chirp three times after all doors are closed. To view available settings from the infotainment screen, touch Settings > Vehicle > Remote Lock, Unlock, Start.

### Remote Removed From Vehicle Alert

If the vehicle is on with a door open, and then all doors are closed, the vehicle will check for remote keys and digital keys inside. If a remote key or digital key is not detected, the Driver Information Center (DIC) will display NO KEY FOUND and the horn will chirp three times. This occurs only once each time the vehicle is driven. To view available settings from the infotainment screen, touch Settings > Vehicle > Remote Lock, Unlock, Start.

### Keyless Tailgate Opening

Press the touchpad on the tailgate to open the tailgate when all doors are unlocked, or when the remote key or digital key is within 1m (3 ft).

See *Tailgate* ⇨ 19.

### Keyless Hood Opening

Press the touchpad in the center of the front fascia once to open the hood when all doors are unlocked, or when the remote key or digital key is within 1m (3 ft).

See *Hood* ⇨ 16.

### Key Access

To access a vehicle with a weak remote key battery, see *Door Locks* ⇨ 13.

### Programming Remote Keys to the Vehicle

Only remote keys programmed to the vehicle will work. If a remote key is lost or stolen, a replacement can be purchased and programmed through your dealer. The vehicle can be reprogrammed so that lost or stolen remote keys no longer work. Each vehicle can have up to eight remote keys programmed to it.

### Starting the Vehicle with a Low Remote Key Battery

For improved vehicle security, the remote key is equipped with a motion sensor. When starting the vehicle, if the remote key has been idle for an extended period of time, the DIC may display KEY IN SLEEP MODE, MOVE KEY, THEN START. Move the remote key slightly and try starting the vehicle.

If the remote key battery is weak or if there is interference with the signal, the DIC may display NO KEY FOUND, REPLACE BATTERY IN

KEY or NO REMOTE KEY WAS DETECTED  
PLACE KEY IN KEY POCKET THEN START YOUR  
VEHICLE when starting the vehicle.

To start the vehicle:



1. Place the remote key in the rear cupholder.
2. With the vehicle in P (Park) or N (Neutral) press the brake pedal and POWER.

Replace the remote key battery and charge the digital key battery as soon as possible.

### Battery Replacement

#### Warning

Never allow children to play with the remote key. The remote key contains a small battery, which can be a choking hazard. If swallowed, internal burns can occur, resulting in severe injury or death. Seek medical attention immediately if a battery is swallowed.

#### Warning

To avoid personal injury, do not touch metal surfaces on the remote key when it has been exposed to extreme heat. These surfaces can be hot to the touch at temperatures above 59 °C (138 °F).

#### Caution

When replacing the battery, do not touch any of the circuitry on the remote key. Static from your body could damage the remote key.

#### Caution

Always replace the battery with the correct type. Replacing the battery with an incorrect type could potentially create a risk of battery explosion. Dispose of used batteries according to instructions and local laws. Do not attempt to burn, crush, or cut the used battery, and avoid exposing the battery to environments with extremely low air pressures or high temperatures.

#### Caution

If the remote key is not reassembled properly, liquids could enter the housing and damage the circuitry, resulting in a remote key malfunction and/or failure. To prevent damage, always follow the steps for remote key reassembly in this manual to ensure the remote key is sealed properly whenever the remote key is opened.

Replace the battery in the remote key soon if the DIC displays REPLACE BATTERY IN REMOTE KEY.



## 12 Keys, Doors, and Windows

To replace the battery:



1. Press the button on the side of the remote key near the bottom and pull the mechanical key out. Never pull the mechanical key out without pressing the button.



2. Use the mechanical key blade in the slot to remove the battery cover by hand.

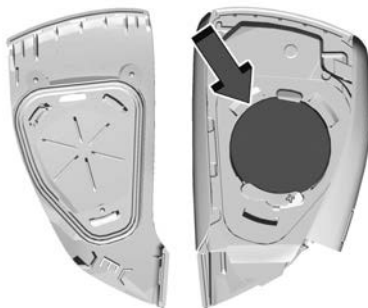

3. Remove the battery cover.

4. Pull the seal by pulling on the tab to access the battery.
5. Remove the old battery. Do not use a metal object.
6. Insert the new battery, positive side facing up. Replace with a CR2450 or equivalent battery.
7. Place the seal back into the groove around the battery compartment.
8. Replace the battery cover by snapping it back into the remote key.
9. Reinsert the mechanical key.

### Remote Vehicle Start

This feature starts the heating or air conditioning systems and the rear window defogger from outside the vehicle.

Use remote start to heat or cool the interior when the vehicle is plugged in to maximize electric range by utilizing electricity from the electrical outlet. Normal system operation will return after the vehicle has been turned on.

 : This button is on the remote key.

The climate control system will use the previous settings during a remote start. The rear defog may come on during a remote

start based on cold ambient conditions. The rear defog indicator light will not come on during a remote start.

Laws in some local communities may restrict the use of remote starters. For example, some laws require a person using remote start to have the vehicle in view. Check local regulations for any requirements.

The vehicle cannot be remote started if:

- The remote key is in the vehicle.
- The hood is open.
- The vehicle has been running for 60 minutes after a remote start.
- The hazard flashers are on.
- The vehicle is not in P (Park).
- The vehicle is already started.

If the battery level is low, do not use the remote start feature. The battery may fully deplete.

The remote key range may be less while the vehicle is running.

Other conditions may affect the range and performance of the remote key. See *Remote Key* ⇨ 7.

### Starting the Vehicle Using Remote Start

Press  twice on the remote key. The turn signal lamps will flash to confirm the remote start request was received. During the remote start, the parking lamps will remain on as long as the vehicle is on.

The vehicle will turn off after 60 minutes, unless you stop the remote start before remote start cycle has completed or the vehicle is turned on.

Press the brake pedal and press POWER  to drive the vehicle.

### Extending Remote Start Time

Remote start can be used for up to 60 minutes of total remote start time.

After a remote start of 60 minutes, or multiple shorter time starts totaling 60 minutes have been used, the vehicle must be started and then turned off before the remote start can be used again.

### Canceling a Remote Start

To cancel a remote start, do one of the following:

- Press . The parking lamps will turn off.
- Turn on the hazard warning flashers.

- Turn the vehicle on and then off.

## Door Locks



### Warning

Unlocked doors can be dangerous.



- Passengers, especially children, can easily open the doors and fall out of a moving vehicle. The doors can be unlocked and opened while the vehicle is moving. The chance of being thrown out of the vehicle in a crash is increased if the doors are not locked. So, all passengers should wear seat belts properly and the doors should be locked whenever the vehicle is driven.
- Young children who get into unlocked vehicles may be unable to get out. A child can be overcome by extreme heat and can suffer permanent injuries or even death from heat stroke. Always lock the vehicle whenever leaving it.
- Outsiders can easily enter through an unlocked door when you slow down or stop the vehicle. Locking the doors can help prevent this from happening.

## 14 Keys, Doors, and Windows

To lock or unlock the doors from outside the vehicle:

- Press  or  on the remote key. See *Remote Key Operation* ⇨ 7.
- Use the mechanical key in the driver door.

To lock or unlock the doors from inside the vehicle:

- Press  or  on the power door lock switch.
- Pulling an interior door handle will unlock the door. Pulling the door handle again unlatches it.

### Keyless Access





The remote key must be within 1 m (3 ft) of the eTrunk™ or door being opened or locked. Press the button on the door handle to open. See “Keyless Access Operation” in *Remote Key Operation* ⇨ 7.

### Free-Turning Locks

The door key lock cylinder turns freely when either the wrong key is used, or the correct key is not fully inserted. The free-turning door lock feature prevents the lock cylinder from being forced open. To reset the lock cylinder, ensure the correct key is fully inserted into the lock cylinder. Rotate the key until you feel the lock cylinder click back into place. Remove the key and reinsert fully, rotate the key to unlock the vehicle.

### Power Door Locks

Press  or  on the Remote Key. See *Remote Key Operation* ⇨ 7.



 : Press to lock the doors. The indicator light in the switch will illuminate when locked.



 : Press to unlock the doors.

### Delayed Locking

This feature delays the locking of the doors until five seconds after all doors are closed.

When  is pressed on the power door lock switch while the door is open, a chime will sound three times indicating delayed locking is active.

The doors will lock automatically five seconds after all doors are closed. If a door is reopened before that time, the five-second timer will reset when all doors are closed again.

Press  on the door lock switch again or press  on the remote key to lock the doors immediately.

This feature can be programmed. To view available settings from the infotainment screen, touch Settings > Vehicle > Power Door Locks.

### Automatic Door Locks

The doors will lock automatically when all doors are closed, the vehicle is on, and the vehicle is shifted out of P (Park).

If a vehicle door is unlocked, and then opened and closed, the doors will lock either when your foot is removed from the brake or the vehicle speed becomes faster than 13 km/h (8 mph).

To unlock the doors:

- Press  on the power door lock switch.
- Shift the vehicle into P (Park).

Automatic door locking cannot be disabled. Automatic door unlocking can be programmed. To view available settings from the infotainment screen, touch Settings > Vehicle > Power Door Locks.

### Lockout Protection

This feature protects you from locking remote keys in the vehicle.

When driver door is open, the lock button is pressed, and the vehicle is on, all of the doors will lock and then the driver door will unlock.



If the vehicle is off and locking is requested while a door is open, when all doors are closed the vehicle will check for remote keys inside. If a remote key is detected and the number of remote keys inside has not reduced, the driver door will unlock and the horn will sound three times.

This can be manually overridden by pressing and holding  on the power door lock switch.



### Safety Locks



The rear door safety locks prevent passengers from opening the rear doors from inside the vehicle.

Press   to activate the safety locks on the rear doors. The indicator light in the switch will illuminate when activated.

The rear door power windows are also disabled. See *Power Windows* ⇨ 29.

Press   again to deactivate the safety locks.

If an inside rear door handle is being pulled at the same time the safety lock is deactivated, only that door will remain

locked and the indicator light may flash. Release the handle, then press the safety lock twice to deactivate the safety locks.

### Digital Key

If equipped and enabled, the Digital Key feature allows you to access and operate the vehicle using a smartphone or other compatible device.

Only certain smartphones and devices support Digital Key. Please see the myGMC mobile app to see determine if your device is compatible.

If the smartphone battery is out of charge, low, or not detected while trying to start the vehicle, the DIC may display NO KEY FOUND. Charge the smartphone battery as soon as possible.

You can use the myGMC mobile app to pair, manage, or delete your Digital Key

#### Setting up Digital Key

Digital Key is only available with an OnStar account associated with the vehicle.

1. Log in to your Digital Key account in the myGMC mobile app. See *Connections* ⇨ 383.

2. Select the Digital Key menu option, and follow the steps on your screen to pair your phone.

#### Using Your Digital Key

Digital Key allows you to:

- Passively lock and unlock the vehicle's doors, and access the front or rear compartments, without a remote key.
- Start the vehicle with your phone present inside the vehicle.

### Doors

#### Hood

Clear any snow from the hood before opening.

#### Warning

You or others could be injured if caught in the path of the power hood. Make sure there is no one in the way of the hood as it is opening and closing.

#### Power Hood Operation

The vehicle must be in P (Park), doors unlocked, or the remote key in range of the vehicle to operate the power hood.

To open or close the power hood, do one of the following:

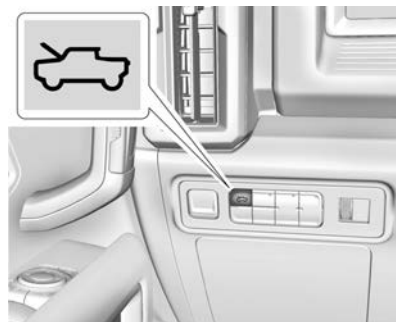

- To open the hood, press  on the instrument panel to the left of the steering wheel once.

To close the hood, press and hold  until the hood closes.

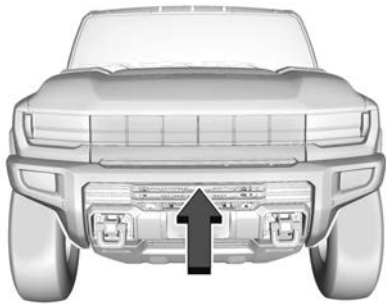

- To open or close the hood, press the touchpad in the center of the front fascia once, when the remote key is within 1 m (3 ft).
- To open the hood with the remote key, press  once, and then immediately press again and hold for at least one second.

To close the hood with the remote key, press  once, and then immediately press again and hold until the hood is closed. See *Remote Key Operation* ⇨ 7.

### Open Settings

To view available settings from the infotainment screen, touch Settings > Vehicle > Comfort and Convenience > Power Hood Opening.

#### Maximum

The hood opens to the full open position. Use caution in this mode to avoid hitting overhead obstructions.

#### Custom

The hood opens to a pre-programmed height below maximum position. To adjust the hood open angle between the preset height and full open, manually move the hood to a desired position. Press  until the exterior lights flash and a chime sounds. The hood cannot be set below the preset minimum programmable height. If no exterior lights flash or sound, then the height adjustment may be too low.

The hood is restricted to only open to a default height when the vehicle is on a steep downhill grade.

#### Off (Manual Operation)

Press and release the touch pad on the front fascia. Lift the hood to open to a desired height.

To close the hood, pull the hood down until it is secured in the latch. When the hood is in the latch, the hood will automatically close.

### Obstacle Detection Features

If the hood encounters an obstacle during a power open or close cycle, the hood will automatically reverse direction and move a short distance away from the obstacle. After removing the obstruction, the power hood operation can be used again.

If the vehicle is locked while the hood is closing and an obstacle is encountered that prevents the hood from completely closing, the horn will sound an alert that the hood did not close.

### Falling Hood Detection

If the power hood encounters excess weight or a possible mechanical failure, a repetitive chime will sound and the hood will close automatically after a power opening cycle.

Interfering with the power hood motion or manually closing the hood too quickly may activate the falling hood detection feature. Allow the hood to complete its operation and wait a few seconds before manually closing the hood.

## 18 Keys, Doors, and Windows

If the hood continues to automatically close after opening, see your dealer for service before using the power hood.

### Operating the Hood when there is no Electrical Power

The manual release cable should only be used for service and/or emergency use, such as loss of vehicle electrical power. Do not store any cargo in the area near the hood release cable.

#### To open the hood:

1. Firmly pull the hood release cable twice to release the hood. It is on the lower left side of the instrument panel.

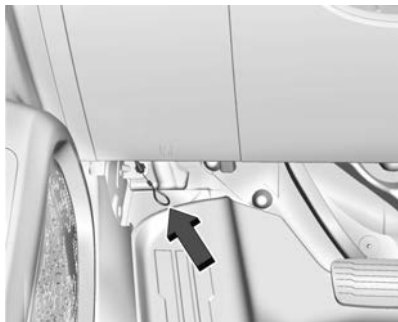

3. Go to the front of the vehicle and lift the hood to the desired height.

#### To close the hood:

1. Before closing the hood, make sure all cargo is properly stowed and does not go above or across the hood seal.
2. Pull the hood down until it is secured in the latch.
3. Check to make sure the hood is latched completely. Push down on the hood to latch if it does not latch completely. Repeat this step with additional force if necessary.

When the hood is not latched, a message will display on the Driver Information Center (DIC) and the vehicle will not be able to shift out of park. To override this function, press and hold the shift button and brake pedal until the DIC message shifter unlock complete is displayed. The vehicle's speed will be limited to 42 km/h (26 mph) when the hood is not completely closed.

If the vehicle has lost power, and the hood is open when the power is restored, the power hood and power closing latch will not operate. To allow powered hood operation again, the hood must be manually closed and fully latched.

### Warning

Do not drive the vehicle if the hood is not latched completely. The hood could open fully, block your vision, and cause a crash. You or others could be injured. Always close the hood completely before driving.

### Emergency Hood Release Button



The underhood compartment is equipped with a glow-in-the-dark emergency hood release button. This button will glow following exposure to light. Press the button to open the hood from inside the underhood compartment.

**⚠ Warning**

The emergency hood release button inside the underhood compartment will not function when the battery is disconnected or depleted. To avoid personal injury or death, always keep the hood fully closed and latched when storing the vehicle. If the hood is not latched, a person could climb into the underhood compartment and inadvertently close the hood. People should never climb inside the underhood compartment. Never shut the hood when a person is inside.

**Tailgate****⚠ Warning**

Make sure there is no one in the way of the power tailgate as it is opening and closing, and keep hands away from the tailgate hinges when in use. You or others could be injured if caught in the path of the power tailgate or tailgate hinges.

**Caution**

To avoid damage to the tailgate, make sure the area behind the tailgate is clear before opening it.

In the case of a dead battery, the tailgate can be opened manually. Contact your dealer or Roadside Assistance.

To lock or unlock the tailgate, use the remote key or the key. See *Remote Key Operation* ⇨ 7.

The vehicle must be in P (Park).

Switches in the inner tailgate prevent the primary tailgate from being opened when the inner tailgate is not fully closed. When the primary or inner tailgate are open, a message may display on the Driver Information Center (DIC).

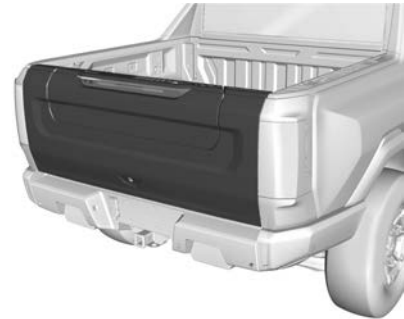

To open the primary tailgate, use one of the following methods:





## 20 Keys, Doors, and Windows

- Press  twice quickly on the remote key until the tailgate moves. See *Remote Key Operation* ⇨ 7. The tailgate can be opened if the remote key is within 1 m (3 ft).

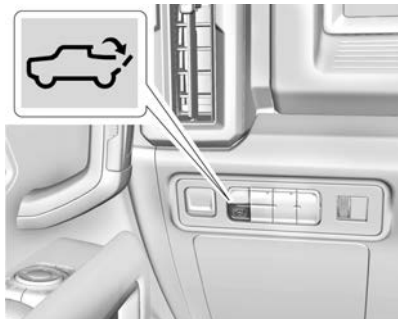

- Press  on the instrument panel to the left of the steering wheel.

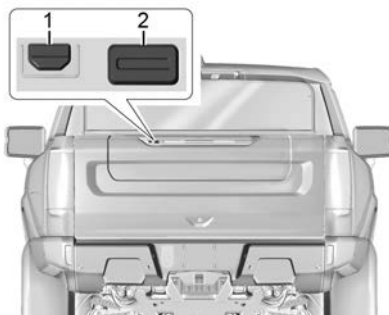

- Press Button 2 to open the primary tailgate. Use the top of the tailgate to pull against if assistance is required. A locked tailgate can be opened if the remote key is within 1 m (3 ft).

To close the primary tailgate, firmly push it upward until it latches. Pull it back to be sure it is latched securely.

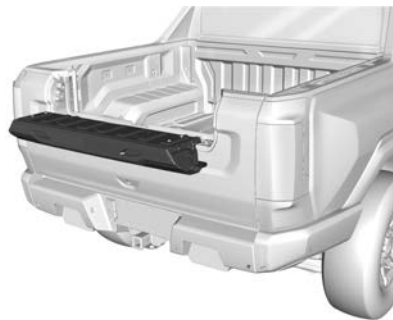

To open the inner tailgate:

Press Button 1 on the tailgate handle after unlocking all doors. Pull the top of the tailgate to open.

The inner tailgate may be equipped with an enable/disable feature to prevent the inner tailgate from being opened when a hitch or other equipment is installed that could damage the inner tailgate. To disable the inner tailgate from opening, ensure that the remote key is within 1 m (3 ft) of the rear bumper and then hold Button 1 on the tailgate handle for 3 seconds. The tail lamps will flash to alert you that the inner gate has been disabled. The inner and outer tailgate can still be operated like a manual tailgate, but the inner gate will not be able

to be opened alone. To enable the inner tailgate function, hold Button 1 on the tailgate handle for 3 seconds while the remote key is within 1 m (3 feet) until the tail lamps flash. The inner tailgate can now be opened separately from the outer tailgate.



**Caution**

To avoid vehicle damage, do not open the inner tailgate when the primary tailgate is open if there is not enough distance to the attached hitch ball or trailer.

To close the inner tailgate with the primary tailgate closed, firmly push or pull it upward until it latches. Pull it back to be sure it is latched securely.

To close the inner tailgate with the primary tailgate open:

- Hold the primary tailgate and firmly close the inner tailgate.
- Raise the inner tailgate so it meets the primary tailgate and close together at the same time.

When using the tailgate step as a load stop, the load must be secured as the load could shift. See *Cargo Tie-Downs* ⇨ 84.

**Tailgate Step**

**Warning**

To avoid personal injury, keep hands away from the hinges when operating the tailgate step.

With the primary and inner tailgates open, the tailgate step can be lowered to access the pickup bed.

**Using the Step**

**Caution**

When using the tailgate as a step, the load rating is 170 kg (375 lb), which includes a person and cargo. Overloading the tailgate step can cause damage to the tailgate system.

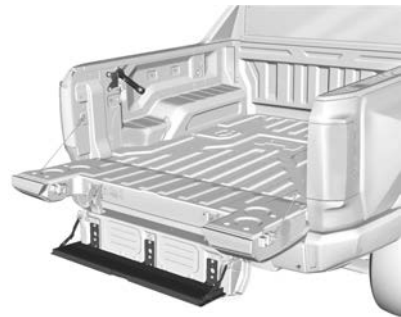

- To lower the tailgate step, press the button at the center of the step. Make sure it lowers to the fully open position.
- To close the tailgate step, lift it firmly. Make sure that both side latches are engaged.

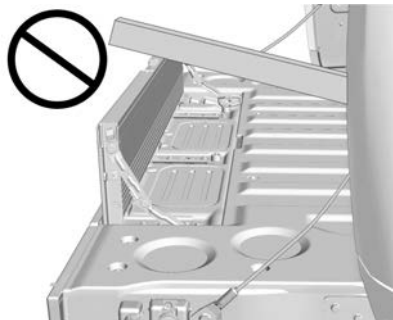

Do not place a load on top of the step when using it as a load stop.

### Using the Assist Handle

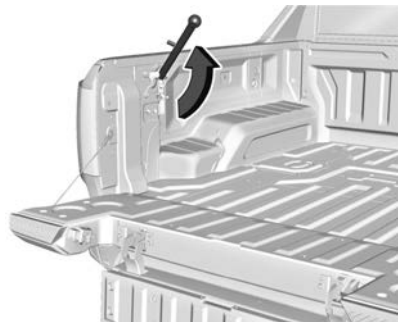

The assist handle helps with entering the pickup box. To use:

1. Lift up on the handle until it locks in the open position.
2. To return the assist handle, pull the release lever toward the ball end of the handle and push the handle back to the closed position.

### Applying Loads to Tailgates

#### Caution

Do not put ramp loads on the inner tailgate alone. Damage to the inner tailgate may occur.

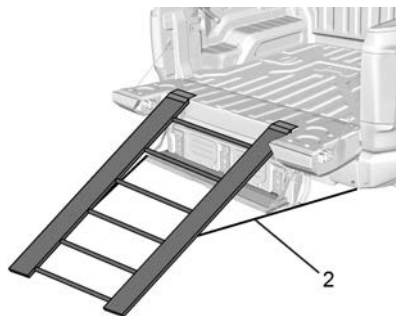

Preferred Method

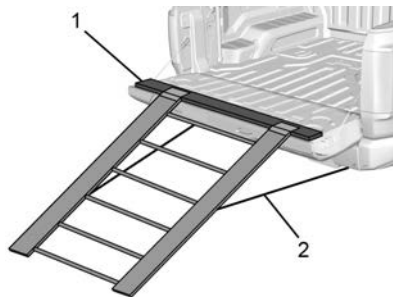

#### Alternate Method

When applying any load to the tailgate, distribute the weight evenly across the width of the tailgate. This applies to all tailgate types.

- Use a load-distributing member (1).
- Secure the ramp to the bumper (2).

### Vehicle Security

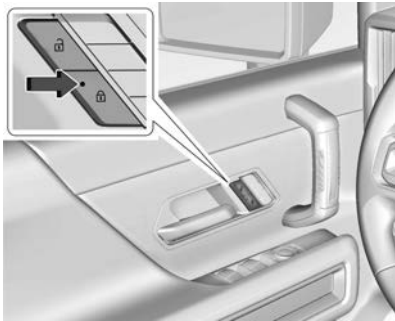

This vehicle has theft-deterrent features; however, they do not make the vehicle impossible to steal.

## Vehicle Alarm System



The indicator light, on the driver door switch, indicates the status of the system. See *Power Door Locks* ⇨ 14

### Arming the Alarm System

1. Turn off the vehicle.
2. Lock the vehicle in one of three ways:
  - Use the remote key.
  - Use the Keyless Access system.
  - With a door open, press  on the interior of the door.
3. After 30 seconds the alarm system will arm, and the indicator light will begin to slowly flash. Pressing  on the remote

key a second time will bypass the 30-second delay and immediately arm the alarm system.

The vehicle alarm system will not arm if the doors are locked with the mechanical key.

If the driver door is opened without first unlocking with the remote key, the horn will chirp and the lights will flash to indicate pre-alarm. If the vehicle is not started, or the door is not unlocked by pressing  on the remote key during the 10-second pre-alarm, the alarm will be activated.

The alarm will also be activated if a passenger door, the tailgate, or the hood is opened without first disarming the system. When the alarm is activated, the turn signals flash and the horn sounds for about 30 seconds. The alarm system will then re-arm to monitor for the next unauthorized event.

### Disarming the Alarm System

To disarm the alarm system or turn off the alarm if it has been activated:

- Press  on the remote key.
- Unlock the vehicle using the Keyless Access system.
- Start the vehicle.

To avoid setting off the alarm by accident:

- Lock the vehicle after all occupants have exited.
- Always unlock a door with the remote key, or use the Keyless Access system. Unlocking the driver door with the mechanical key will not disarm the system or turn off the alarm.

### How to Detect a Tamper Condition

If  is pressed on the remote key and the horn chirps three times, an alarm occurred previously while the alarm system was armed.

If the alarm has been activated, a message will appear on the Driver Information Center (DIC).

### Steering Column Lock

If equipped, the steering column lock is a theft-deterrent device. This feature locks the steering column when the vehicle is turned off and the driver door is opened, or when the driver door is opened and then the vehicle is turned off. The steering column unlocks when the vehicle is turned on.

The Driver Information Center (DIC) may display one of these messages:

- A message to service the steering column lock indicates that an issue has been detected with the column lock feature and the vehicle should be serviced.
- A message that the steering column is locked indicates that the vehicle is on, but the steering column is still locked. It is normal for the column to be locked during a remote start, but the column should unlock after the brake pedal is pressed and the vehicle is started. No message will display during a remote start.
- A message that the steering wheel must be turned and the vehicle must be started again indicates that the column lock mechanism is bound, the column locking device was unable to unlock the steering column, and the vehicle did not start. If this happens, immediately turn the steering wheel from side to side to unbind the column lock. If this does not unlock the steering column, turn the vehicle off and open the driver door to reset the system. Then turn the vehicle on and immediately turn the steering

wheel side to side for about 15 seconds. In some cases, it may take significant force to unbind the column.

To keep the steering column from binding, straighten the front wheels before turning off the vehicle.

### Immobilizer

See *Radio Frequency Statement* ⇨ 374.

### Immobilizer Operation

This vehicle has a passive theft-deterrent system.

The system does not have to be manually armed or disarmed.

The vehicle is automatically immobilized when the vehicle is turned off.

The immobilization system is disarmed when the vehicle is turned on and a valid remote key is present in the vehicle.



The security light in the instrument cluster comes on if there is a problem with arming or disarming the theft-deterrent system.

The system has one or more remote keys matched to an immobilizer control unit in the vehicle. Only a correctly matched remote key will start the vehicle. If the remote key is ever damaged, you may not be able to start your vehicle.

When trying to start the vehicle, the security light may come on briefly.

If the vehicle does not start and the security light stays on, there is a problem with the system. Turn the vehicle off and try again.

If the vehicle will not turn on or off, and the remote key appears to be undamaged, try another remote key. You may also try placing the remote key in the backup location. See *Remote Key Operation* ⇨ 7.

If the vehicle will not turn on or off with the other remote key or in the backup location, the vehicle needs service. If the vehicle does turn on or off, the first remote key may be faulty. See your dealer.

It is possible for the immobilizer system to learn new or replacement remote keys. Up to eight remote keys can be programmed for the vehicle. To program additional

remote keys, see “Programming Remote Keys to the Vehicle” under *Remote Key Operation* ⇨ 7.

Do not leave the remote key or device that disarms or deactivates the theft-deterrent system in the vehicle.

## Exterior Mirrors

### Power Mirrors



To adjust the mirrors:

1. Press or to select the driver or passenger side mirror. The indicator light comes on.

2. Press the arrows on the control pad to move the mirror up, down, right, or left.
3. Adjust the outside mirror so that the side of the vehicle and the area behind are seen.
4. Press either or again to deselect the mirror. The indicator light goes off.

### Puddle Lamps

Puddle lamps project light to the area of ground below the front and rear doors, on both the driver and passenger side. See *Entry Lighting* ⇨ 127 and *Exit Lighting* ⇨ 127.

### Memory Mirrors

The vehicle may have memory mirrors. See *Memory Seats* ⇨ 40.

### Lane Change Alert (LCA)

The vehicle may have LCA. See *Lane Change Alert (LCA)* ⇨ 248.

## Folding Mirrors



To adjust power folding mirrors:

1. Press to fold the mirrors inward.
2. Press again to return the mirrors to the driving position.

The outside mirrors may automatically unfold when the vehicle is driven above 20 km/h (12 mph), but may be folded with the power folding mirror switch. If the vehicle speed is driven above 40 km/h (25 mph), they may automatically unfold and may not be refolded with the power folding mirror switch.

### Resetting the Power Folding Mirrors

Reset the power folding mirrors if:



- The mirrors are accidentally obstructed while folding.
- They are accidentally manually folded/unfolded.
- The mirrors do not stay in the unfolded position.
- The mirrors vibrate at normal driving speeds.

Fold and unfold the mirrors one time using the mirror controls to reset them to their normal position. A noise may be heard during the resetting of the power folding mirrors. This sound is normal after a manual folding operation.

### Remote Mirror Folding

If the mirrors have been folded with the power folding mirror switch, they may not be unfolded by use of remote key.

If the mirrors have not been folded with the power folding mirror switch and the vehicle is in P (Park), they may be automatically folded/unfolded as follows:

- If doors are locked by pressing  on the remote key, the mirrors will fold. If doors are unlocked by pressing  on the remote key, the mirrors will unfold. See *Remote Key Operation* ⇨ 7.
- If doors are locked by pressing the door handle button, the mirrors will fold. If doors are unlocked by pressing the door handle button, the mirrors will unfold. See “Keyless Unlocking/Locking from the Driver Door” in *Remote Key Operation* ⇨ 7.
- If passive locking is enabled and doors are locked by that feature, the mirrors will fold. See “Passive Locking” in *Remote Key Operation* ⇨ 7.

### Heated Mirrors

To heat the mirrors, press  on the infotainment display.

See “Rear Window Defogger” under *Dual Automatic Climate Control System* ⇨ 156.

### Automatic Dimming Mirror

The driver outside mirror automatically adjusts for the glare of the headlamps from behind. This feature comes on when the vehicle is started.

### Reverse Tilt Mirrors

If equipped with reverse tilt mirrors and memory seats, the passenger and/or driver mirror tilts to a preselected position when the vehicle is in R (Reverse). This allows the curb to be seen when parallel parking.

The mirror(s) may move from their tilted position when:

- The vehicle is shifted out of R (Reverse), or remains in R (Reverse) for about 30 seconds.
- The vehicle is turned off.
- The vehicle is driven in R (Reverse) above a set speed.

To view available settings from the infotainment screen, touch Settings > Vehicle > Comfort and Convenience.

### Interior Mirrors

#### Interior Rearview Mirrors

Adjust the rearview mirror for a clear view of the area behind the vehicle.

Do not spray glass cleaner directly on the mirror. Use a soft towel dampened with water.

## Automatic Dimming Rearview Mirror

Automatic dimming reduces the glare of headlamps from behind. The dimming feature comes on when the vehicle is started.

## Rear Camera Mirror

The rear camera mirror provides a wide angle camera view of the area behind the vehicle.

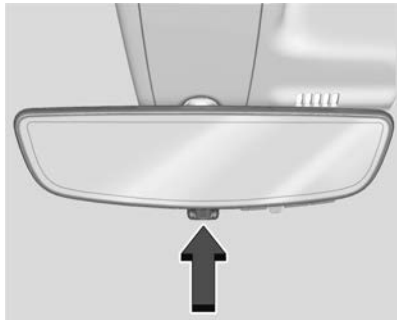

Pull the tab to turn on the display. Push the tab to turn it off. When off the mirror is automatic dimming. Adjust the mirror for a clear view of the area behind the vehicle while the display is off.

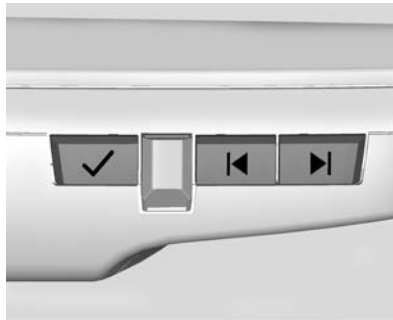

Press ✓ to scroll through the adjustment options.

Press ◀ and ▶ to adjust the settings using the indicators on the mirror. The indicators will remain visible for five seconds after the last button activation, and the settings will remain saved.

The adjustment options are:

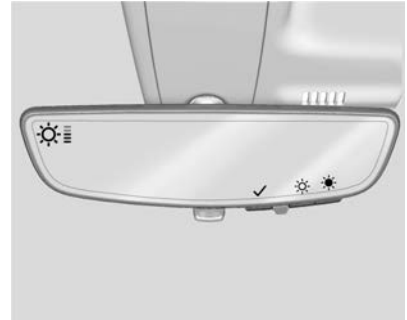

- Brightness

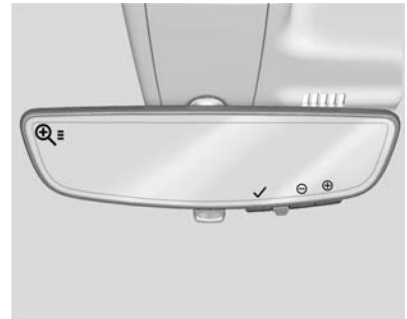

- Zoom



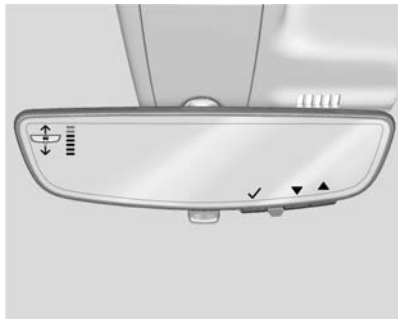

- Tilt

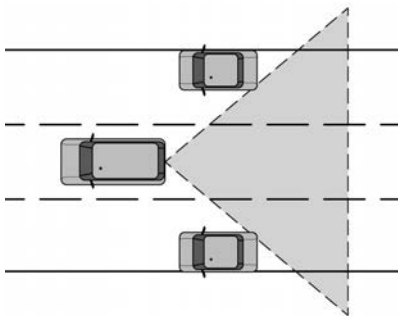

### Warning

The Rear Camera Mirror (RCM) has a limited view. Portions of the road, vehicles, and other objects may not be seen. Do not drive or park the vehicle using only this camera. Objects may appear closer than they are. Check the outside mirrors or glance over your shoulder when making lane changes or merging. Failure to use proper care may result in injury, death, or vehicle damage.

### Troubleshooting

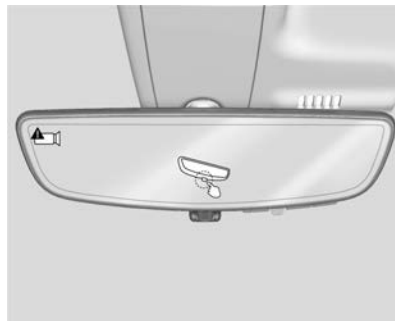

See your dealer for service if a blue screen and  are displayed in the mirror, and the display shuts off. Also, push the tab as indicated to return to the automatic dimming mode.

The Rear Camera Mirror may not work properly or display a clear image if:

- There is glare from the sun or headlamps. This may obstruct objects from view. If needed, push the tab to turn off the display.
- Dirt, snow, or other debris blocks the camera lens. Clean the lens with a soft damp cloth.
- The camera's mounting on the vehicle has been damaged, and/or the position or the mounting angle of the camera has changed.

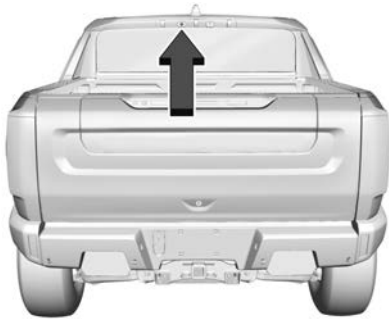

## Windows

### Warning

Never leave a child, a helpless adult, or a pet alone in a vehicle, especially with the windows closed in warm or hot weather. They can be overcome by the extreme heat and suffer permanent injuries or even death from heat stroke.



The vehicle aerodynamics are designed to improve vehicle range performance. This may result in a pulsing sound when either rear window is down and the front windows are up. To reduce the sound, open either a front window or the sunroof, if equipped.

## Power Windows

### Warning

Children could be seriously injured or killed if caught in the path of a closing window. Never leave the remote key in a vehicle with children. When there are  
(Continued)

### Warning (Continued)

children in the rear seat, use the window lockout switch to prevent operation of the windows. See *Keys* ⇨ 6.



The power windows work when the vehicle is on, or when Retained Accessory Power (RAP) is active. See *Retained Accessory Power (RAP)* ⇨ 182.



Using the window switch, press to open or pull to close the window.



The windows may be temporarily disabled if they are used repeatedly within a short time.

### Window Lockout



This feature stops the rear door passenger window switches from working except from the driver position.

Press   to engage the rear window lockout feature. The indicator light is on when engaged.

Press   again to disengage.

### Windows Express Movement

All windows can be opened without holding the window switch. Press the switch down fully and quickly release to express open the window.

Briefly press or pull the window switch to stop that window's express movement.

### Express Window Down

 This button will be on the instrument panel to the left of the steering wheel.

Press and release  to open all driver, front passenger, and rear passenger side windows.

Use the door-mounted power window switches to close each window.

### Programming the Power Windows

Programming may be necessary if the vehicle battery has been disconnected or discharged. If the window is unable to express-up, program each express-close window:

1. Close all doors.
2. Turn the vehicle on.
3. Partially open the window to be programmed. Then close it and continue to pull the switch briefly after the window has fully closed.
4. Open the window and continue to press the switch briefly after the window has fully opened.

### Remote Window Operation

If equipped, this feature allows the windows to be opened remotely. If enabled in vehicle personalization, press and hold  on the remote key. To view available settings from the infotainment screen, touch Settings > Vehicle > Remote Lock, Unlock, Start.

### Rear Windows

#### Rear Drop Window

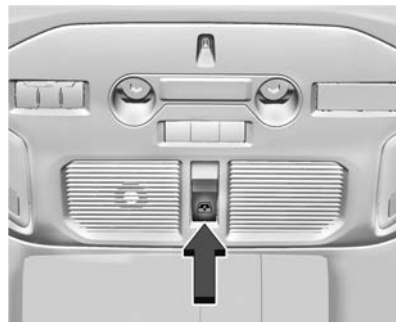

If equipped, the rear drop window works when the vehicle is on, or Retained Accessory Power (RAP) is active. See *Retained Accessory Power (RAP)* ⇨ 182.

- Press the switch to open the window.

- Pull the switch to close the window.

The rear drop window cannot be operated manually.

## Sun Visors

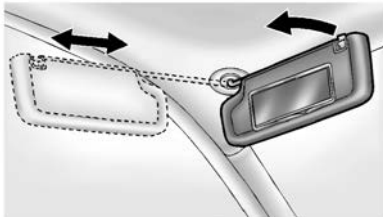

Pull the sun visor down to block glare. If equipped, detach the sun visor from the center mount to pivot to the side window or to extend along the rod.

If equipped, there is a lighted mirror on the sun visor. Lift the cover to open.

## Roof

### Roof Panel

Use the following procedures to remove or install the removable roof panel system.

There are four separate roof panels. Each panel can be removed independently. There is also a center bar (I-Bar) over the front seating row which can be removed as well.

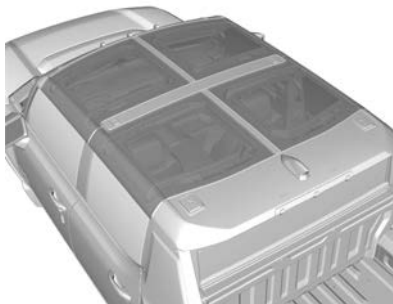

### Caution

If a roof panel is dropped or rested on its edges, the roof panel, and/or weatherstripping may be damaged. Always place the roof panels in the eTrunk™ after removing them from the vehicle.

### Caution

Use care when storing and removing the roof panel. The roof panel pins and vehicle finish can be damaged if the roof contacts the vehicle.

## Removing the Roof Panels

### Warning

Do not remove a roof panel while the vehicle is moving. The panel could fall into the vehicle and strike an occupant and cause you to lose control. It could also fly off and strike another vehicle. Remove the roof panel only when the vehicle is parked.

To remove:

1. Shift the vehicle into P (Park).
2. Turn the vehicle off and set the parking brake.
3. Open the eTrunk™ and remove any items that may interfere with proper storage of the roof panels. See *Underhood Storage (eTrunk™)* ⇨ 83.  
Each panel has two release handles.



4. To unlock the release handles, pull them outward and turn them until they stop.
5. Stand on the side of the vehicle. Carefully lift the outboard edge of the roof panel up to disengage the vertical pins, then pull outward to disengage the horizontal pins from the I-Bar. Avoid dropping the inboard edge downward.
6. When the roof panel is loose, grasp it as close to the center as possible and lift it away from the vehicle.

### Storing the Roof Panels

#### Warning

In a collision, sudden stop, or other maneuver, an improperly stored roof panel could cause personal injury or vehicle damage. Always use the stowage system provided and follow stowage instructions.

Use stowage bags for each roof panel. Never store the roof panels outdoors and uncovered.

You may also stow just the front row of panels.

The included Roof Panel Stowage System is only meant for short trips over paved roads. This system is not sufficient for protection of the roof panels during off-roading. For off-road protection please see the Accessory Hummer EV Roof Panel Stowage Kit.

To put into stowage:

1. Shift the vehicle into P (Park).
2. Turn the vehicle off and set the parking brake.

3. Open the hood and retrieve the four roof panel stowage bags, removing them from the vehicle completely.
4. Open the first roof panel bag, and place inside the eTrunk™, with the handles facing the front of the vehicle and the Hummer EV logo on top.
5. Place panel into bag with weatherstrip side facing toward rear of vehicle.
6. Close bag with the zipper, ensure zipper is fully closed.
7. Repeat Steps 4-6 for each additional roof panel, placing each bag on top of the last bag. This can be done for just the front row of roof panels, or all four roof panels.
8. Install the two retention straps from rear cargo hook to front cargo hook, being careful to ensure straps are holding down bags.



9. Close the hood.

### Removing Roof Panels from Stowage

#### Caution

Do not place roof panels on the ground when removing them from stowage. Setting a roof panel on the ground can damage the weatherstrip.

To remove from stowage:

1. Shift the vehicle into P (Park).
2. Turn the vehicle off and set the parking brake.
3. Open the hood and remove the retention strapping holding the bags into place.

4. Unzip the upper most bag to reveal the roof panel inside. Remove the roof panel from bag and place in desired location or reinstall to the roof of vehicle.
5. Close empty bag and place aside.
6. Repeat Steps 4-5 for all remaining roof panel bags.
7. Fold the roof panel bags up together and place them back into the eTrunk™ and close.

### Removing the I-Bar

#### ⚠ Warning

Never remove the I-Bar while the vehicle is moving. A roof panel could fall into the vehicle and strike an occupant, fly off and strike another vehicle, and/or you could lose control of the vehicle and crash. Remove the I-Bar only when the vehicle is parked.

To remove:

1. Shift the vehicle into P (Park).
2. Turn the vehicle off and set the parking brake.
3. Retrieve ratchet, extension, and bit from tool storage and assemble.

4. Using the tools, remove the four nuts holding the I-Bar to the vehicle.
5. Push upward on the I-Bar to detach and remove from roof of vehicle.

For normal driving conditions, make sure the I-bar is securely fastened in place with the provided tools. If you remove the I-bar during the course of removing the front infinity roof system, make sure to store the I-bar in a secure location, such as your home or garage. If the I-bar is left unsecured or loosely stowed inside the vehicle, it could cause significant injury in a crash.

### Installing the I-Bar

#### ⚠ Warning

An improperly installed I-Bar may prevent proper installation and retention of the roof panels. Always ensure all nuts are tightened before operating the vehicle.

If the I-Bar is not installed correctly, water may leak into the vehicle.

To install:

1. Shift the vehicle into P (Park).
2. Turn the vehicle off and set the parking brake.

- Carefully attach the I-Bar to the roof and make sure that it is properly oriented. The front of the I-Bar has the word "FRONT" on the I-Bar, it is on the underside of the weatherstrip. The front has black push pins and the back has red push pins. The studs of the I-Bar should easily drop through the attachment holes in the roof. Ensure it is fully seated.
- Retrieve ratchet, extension, and bit from tool storage and assemble.

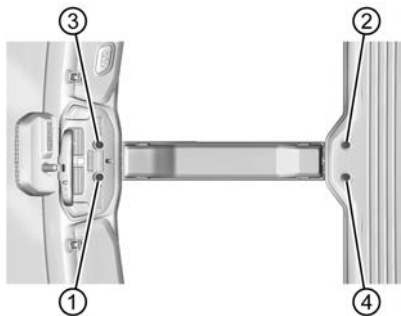

- Using the tools, install the four I-Bar nuts. It is recommended that they are all hand-tightened, and then firmly

tightened using the proper tool. To ensure a proper seal, evenly tighten the I-Bar nuts in the proper sequence shown.

- Return the tools to tool storage.

### Installing the Roof Panels

#### Warning

An improperly attached roof panel may fall into or fly off the vehicle. You or others could be injured. After installing the roof panel, always check that it is firmly attached by pushing up on the underside of the panel. Check now and then to be sure the roof panel is firmly in place.

#### Caution

Installing the roof with the release handles in the closed position could cause damage. Always move handles to the open position when installing the roof.

The front I-Bar must be installed and secured before the front panels can be installed. The individual roof panels can be installed in any order.

To install:

- Shift the vehicle into P (Park).
- Turn the vehicle off and set the parking brake.
- Remove the roof panel from the eTrunk™ and remove the panel from the bag. Use the panel identification marking on the frame to determine where the panel goes.



- Make sure that both release handles are in the fully open position.
- Carefully place the roof panel into its designated location. Position the inboard edge of the roof panel next to the

weatherstrip on the I-Bar, then align and fit the horizontal pins into the receivers on the I-Bar.

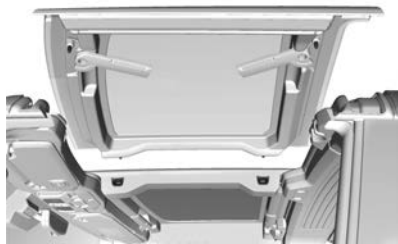

6. When aligning the pins and receivers, make sure the inboard edge of the roof panel does not come in contact with the roof seals. Ensure that the inboard edge is far enough in that it clears the I-Bar weatherstrip. Ensure that the I-Bar weatherstrip is lying flush with the adjacent roof seals before fully engaging the pins into the receivers. Failure to do so may damage the weatherstrip or lead to an improper seal.



Correct Assembly

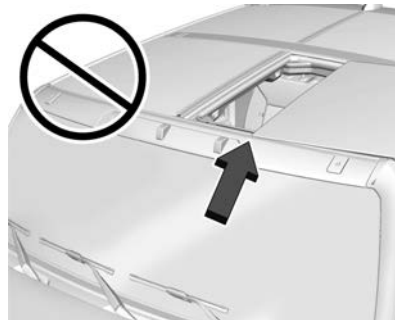

Incorrect Assembly

7. Gently lower the outboard edge of the roof panel. Push the roof panel firmly downward to engage the vertical pins.
8. Turn the release handles inward so that they fully latch in the closed position. It is critical that the handles fully latch.

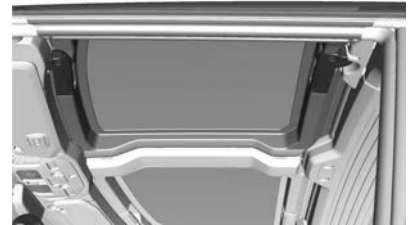

9. Push and pull the roof panel up and down, and side to side, to ensure the roof panel is securely installed.



### **Maintaining the Roof Panel**

When cleaning, removing, and/or storing the roof panel:

- Flush with water to remove dust and dirt, then dry the panel.
- Do not use abrasive cleaning materials on the panel.

## Seats and Restraints

### Head Restraints

Head Restraints ..... 37

### Front Seats

Power Seat Adjustment ..... 39  
 Reclining Seatbacks ..... 39  
 Lumbar Adjustment ..... 40  
 Memory Seats ..... 40  
 Heated and Ventilated Front Seats ..... 43

### Rear Seats

Rear Seats ..... 44  
 Heated Rear Seats ..... 45

### Seat Belts

Seat Belts ..... 46  
 Buckle To Drive ..... 47  
 How to Wear Seat Belts Properly ..... 47  
 Lap-Shoulder Belt ..... 49  
 Seat Belt Use During Pregnancy ..... 52  
 Seat Belt Extender ..... 52  
 Safety System Check ..... 52  
 Seat Belt Care ..... 52  
 Replacing Seat Belt System Parts after a  
 Crash ..... 53

### Airbag System

Airbag System ..... 53  
 Where Are the Airbags? ..... 54

When Should an Airbag Inflate? ..... 55  
 What Makes an Airbag Inflate? ..... 56  
 How Does an Airbag Restrain? ..... 56  
 What Will You See after an Airbag  
 Inflates? ..... 56  
 Passenger Sensing System ..... 57  
 Servicing the Airbag-Equipped  
 Vehicle ..... 61  
 Adding Equipment to the  
 Airbag-Equipped Vehicle ..... 61  
 Airbag System Check ..... 62  
 Replacing Airbag System Parts after a  
 Crash ..... 62

### Child Restraints

Older Children ..... 62  
 Infants and Young Children ..... 64  
 Child Restraint Systems ..... 66  
 Where to Put the Restraint ..... 67  
 Lower Anchors and Tethers for Children  
 (LATCH System) ..... 69  
 Replacing LATCH System Parts After a  
 Crash ..... 77  
 Securing Child Restraints (With the Seat  
 Belt in the Rear Seat) ..... 77  
 Securing Child Restraints (With the Seat  
 Belt in the Front Seat) ..... 79

## Head Restraints

The vehicle's front seats have adjustable head restraints in the outboard seating positions.

### Warning

With head restraints that are not installed and adjusted properly, there is a greater chance that occupants will suffer a neck/spinal injury in a crash. Do not drive until the head restraints for all occupants are installed and adjusted properly.

If your vehicle has rear head restraints that fold down, always return them to the full upright position whenever an occupant is seated in the seat.



Adjust the head restraint so that the top of the restraint is at the same height as the top of the occupant's head. This position reduces the chance of a neck injury in a crash.

### Front Seats

The vehicle's front seats have adjustable head restraints in the outboard seating positions.

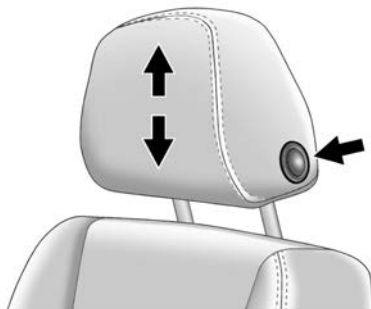

The height of the head restraint can be adjusted.

To raise or lower the head restraint, press the button located on the side of the head restraint and pull up or push the head restraint down, and release the button. Pull and push on the head restraint after the button is released to make sure that it is locked in place.

The front seat outboard head restraints are not removable.

### Rear Head Restraints

The vehicle's rear seat has head restraints in the outboard seating positions that cannot be adjusted.

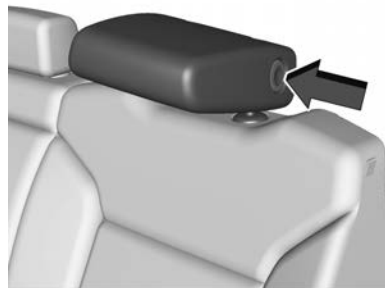

The head restraint can be folded forward to allow for better visibility when the rear seat is unoccupied. To fold the head restraint, press the button on the side of the head restraint.

When an occupant is in the seat, always return the head restraint to the upright position until it locks into place. Push and pull on the head restraint to make sure that it is locked.

If you are installing a child restraint in the rear seat, see *Lower Anchors and Tethers for Children (LATCH System)* ⇨ 69.

### Center Headrest

The vehicle's rear seat may be equipped with a headrest in the center seating position that cannot be adjusted.

If you are installing a child restraint in the rear seat, see *Lower Anchors and Tethers for Children (LATCH System)* ⇨ 69.

## Front Seats

### Power Seat Adjustment

#### Warning

You can lose control of the vehicle if you try to adjust a driver seat while the vehicle is moving. Adjust the driver seat only when the vehicle is not moving.

#### Warning

The power seats will work with the vehicle off. Children could operate the power seats and be injured. Never leave children alone in the vehicle.

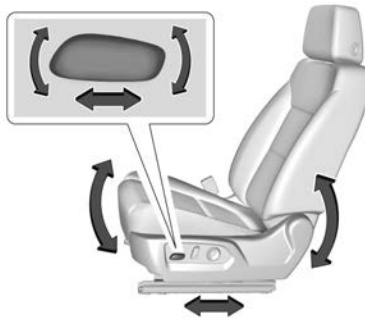

To adjust the seat:

- Move the seat forward or rearward by sliding the control forward or rearward.
- If equipped, raise or lower the front part of the seat cushion by moving the front of the control up or down.
- Raise or lower the seat by moving the rear of the control up or down.

### Reclining Seatbacks



To recline the seatback:

- Tilt the top of the control rearward to recline.
- Tilt the top of the control forward to raise.

#### Warning

Sitting in a reclined position when the vehicle is in motion can be dangerous. Even when buckled up, the seat belts cannot do their job.

(Continued)

**Warning (Continued)**

The shoulder belt will not be against your body. Instead, it will be in front of you. In a crash, you could go into it, receiving neck or other injuries.

The lap belt could go up over your abdomen. The belt forces would be there, not at your pelvic bones. This could cause serious internal injuries.

For proper protection when the vehicle is in motion, have the seatback upright. Then sit well back in the seat and wear the seat belt properly.

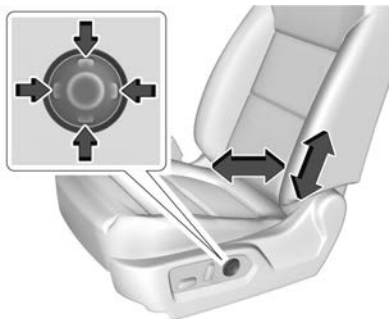

Do not have a seatback reclined if the vehicle is moving.

**Lumbar Adjustment**

- Press and hold the front or rear of the control to increase or decrease lumbar support.
- If equipped, press and hold the top or bottom of the control to raise or lower lumbar support.

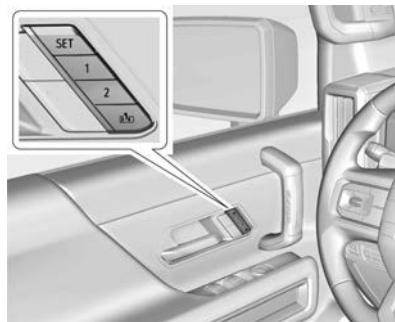
**Memory Seats****Overview**

If equipped, the memory seat feature allows drivers to save their unique driving positions and a shared exit position. See “Saving Seating Positions” later in this section. The saved positions can be recalled manually by all drivers. See “Manually Recalling Seating Positions” later in this section. Drivers with remote key 1 and 2 can also recall them automatically. See “Auto Seat Entry Memory Recall” or “Auto Seat Exit Memory Recall” later in this section. To enable automatic recalls, turn on Seat Entry Memory and/or Seat Exit Memory. See “Enabling Automatic Recalls” later in this section. The memory

recalls may be canceled at any time during the recall. See “Cancel Memory Seating Recalls” later in this section.

### Identifying Driver Number

The vehicle identifies the current driver by their remote key number 1–8. The current remote key number may be identified by Driver Information Center (DIC) welcome message, “You are driver x for memory recalls.” This message is displayed the first few times the vehicle is turned on when a different remote key is used. For Seat Entry Memory to work properly, save positions to the 1 or 2 memory button matching the driver number of this welcome message. To aid in identifying remote key IDs, it is recommended to only carry one remote key when entering the vehicle. Perform the following if the welcome message is not displayed:

1. Move all remote keys away from the vehicle.
2. Turn the vehicle on with another remote key. A DIC welcome message should display indicating the driver number of the other remote key. Turn the vehicle off and remove the other remote key from the vehicle.

3. Turn the vehicle on with the initial remote key. The DIC welcome message should display the driver number of the initial remote key.

### Saving Seating Positions



Read these instructions completely before saving memory positions.

To save preferred driving positions to 1 and 2:

1. Turn the vehicle on. A DIC welcome message may indicate the driver number of the current remote key. See “Identifying Driver Number” previously in this section.
2. Adjust all available memory features to the desired driving position.
3. Press and release SET; a beep will sound.
4. Immediately upon releasing SET, press and hold memory button 1 or 2 matching the current Driver’s remote key number until two beeps sound. If too much time passes between releasing SET and pressing 1 or 2, the two beeps will not sound indicating memory position were not saved. Repeat Steps 3 and 4 to try again.

5. Repeat Steps 1–4 for the other remote key 1 or 2 using the other 1 or 2 memory button.

It is recommended to save the preferred driving positions to both 1 and 2 if you are the only driver.

To save the common exit seating position to  that is used by all drivers for Manually Recalling Seating Positions and Auto Seat Exit Memory Recall features, repeat Steps 1–4 using , the exit button.

### Manually Recalling Seating Positions

Press and hold 1, 2, or  button until the recall is complete, to recall the positions previously saved to that button.

Manual Memory recall movement for 1, 2 or  buttons may be initiated and will complete to the saved memory position if the vehicle is in or out of P (Park).

### Enabling Automatic Recalls

- Seat Entry Memory moves the driver seat to the selected 1 or 2 position when the vehicle is started. Select Settings > Vehicle > Seating Position > Seat Entry Memory > ON or OFF. See “Auto Seat Entry Memory Recall” later in this section.

- Seat Exit Memory moves the driver seat to the preferred exit position of the  button when the vehicle is turned off and the door is opened. Select Settings > Vehicle > Seating Position > Seat Exit Memory > Select ON or OFF. See “Auto Seat Exit Memory Recall” later in this section.

### Auto Seat Entry Memory Recall

Seat Entry Memory will automatically begin movement to the seating positions of the 1 or 2 button corresponding to the driver’s remote key number 1 or 2 detected by the vehicle when:

- The vehicle is turned ON.
- Seating positions have been previously saved to the same 1 or 2 button. See “Saving Seating Positions” previously in this section.
- Seat Entry Memory is enabled. See “Enabling Automatic Recalls” previously in this section.
- The shift lever is in P (Park).

Seat Entry Memory Recall will continue if the vehicle is shifted out of P (Park) prior to reaching the saved memory position.

If the saved memory seat position does not automatically recall, verify the recall is enabled. See “Enabling Automatic Recalls” previously in this section.

If the memory seat recalls to the wrong position, the driver’s remote key number 1 or 2 may not match the memory button number positions they were saved to. Try the other remote key or try saving the positions to the other 1 or 2 memory button. See “Saving Seating Positions” previously in this section.

Automatic Seat Entry Memory recalls are only available for driver’s remote key numbers 1 and 2. Remote keys 3–8 will not provide Seat Entry Memory recalls.

### Auto Seat Exit Memory Recall

Seat Exit Memory will begin movement to the seating position of the  button when:



- The vehicle is turned off and the driver door is open or opened within a short time.
- A seating position has previously been saved to the  memory button. See “Saving Seating Positions” previously in this section.

- Seat Exit Memory is enabled. See “Enabling Automatic Recalls” previously in this section.
- The shift lever is in P (Park).

Seat Exit Memory recall will continue if the vehicle is shifted out of P (Park) prior to reaching the saved memory position.

Seat Exit Memory is not linked to the driver’s remote key. The seating position saved to  is used for all drivers.

### Cancel Memory Seating Recalls

- During any memory recall:
  - Press a power seat control
  - Press SET memory button
- During Manual memory recall:
  - Release 1, 2, or  memory button
- During Auto Seat Entry Memory Recall:
  - Turn vehicle off
  - Press SET, 1, 2, or  memory buttons
- During Auto Seat Exit Memory Recall:
  - Press SET, 1, 2, or  memory buttons

## Obstructions

If something has blocked the seat while recalling a memory position, the recall may stop. Remove the obstruction and try the recall again. If the memory position still does not recall, see your dealer.

## Heated and Ventilated Front Seats

### Warning

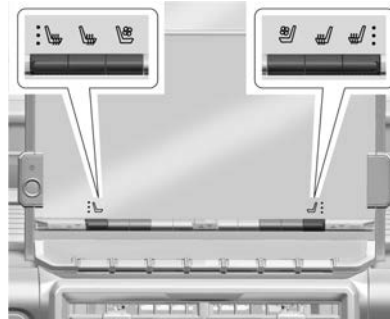

If temperature change or pain to the skin cannot be felt, the seat heater may cause burns. To reduce the risk of burns, use care when using the seat heater, especially for long periods of time. Do not place anything on the seat that insulates against heat, such as a blanket, cushion, cover, or similar item. This may cause the seat heater to overheat. An overheated seat heater may cause a burn or may damage the seat.





**Heated and Ventilated Seat Buttons Shown,  
Heated Seat Buttons Similar**

The buttons are near the climate controls on the center stack. To operate, the vehicle must be on.

To operate, press the button below the driver or passenger seat icon to launch the seat climate function. The panel will remain open for approximately five seconds.

Press the button below  or  to heat the driver or passenger seat.

Press the button below  or  to ventilate the driver or passenger seat. A ventilated seat has a fan that pulls or pushes air through the seat. The air is not cooled.

When a heated seat is turned on, the icon turns red. When a ventilated seat is turned on, the icon turns blue.

Touch the button once for the highest setting. With each touch of the button, the seat will change to the next lower setting, and then to the off setting. The indicator lights next to the icons indicate three for the highest setting and one for the lowest. If the heated seats are on high, the level will automatically lower after approximately 30 minutes.

The passenger seat may take longer to heat up.

### **Auto Heated and Ventilated Seats**

When the vehicle is on, this feature, if equipped, will automatically activate the heated seats and steering wheel or ventilated seats at the level required by the vehicle's interior temperature.



The active high, medium, low, or off heated or ventilated seat level will be indicated by the manual heated or ventilated seat buttons on the center stack. Use the manual heated or ventilated seat buttons on the center stack to turn auto heated or ventilated seats off. The auto heated seats and steering wheel can also be turned off using the heated steering wheel button. If the passenger seat is unoccupied, the auto heated or ventilated seats feature will not activate that seat. To enable or disable auto heated or ventilated seats, select Settings > Vehicle > Climate and Air Quality > Auto Cooled or Auto Heated Seats > ON or OFF.

See *Heated Steering Wheel* ⇨ 87.

### **Remote Start Heated and Ventilating Seats**

During a remote start, the heated or ventilated seats can be turned on automatically. When it is cold outside, the heated seats turn on, and when it is hot outside the ventilated seats turn on. If the auto heated or ventilated seats feature, if equipped, is not turned on, the heated or ventilated seats may be canceled when the vehicle is turned on. If necessary, press the heated or ventilated seat button to use the heated or ventilated seats after the vehicle is turned on.

The heated or ventilated seat indicator lights may turn on during a remote start.

The temperature performance of an unoccupied seat may be reduced. This is normal.

To enable or disable remote start heated or ventilated seats, select Settings > Vehicle > Remote Lock, Unlock, and Start > Remote Start Auto Heat Seats or Remote Start Auto Cool Seats > ON or OFF. See *Remote Vehicle Start* ⇨ 12.

## **Rear Seats**

### **Rear Seat Reminder**

If equipped, the message REAR SEAT REMINDER LOOK IN REAR SEAT displays under certain conditions indicating there may be an item or passenger in the rear seat. Check before exiting the vehicle.

This feature will activate when a second row door is opened while the vehicle is on or up to 10 minutes before the vehicle is turned on. There will be an alert when the vehicle is turned off. The alert does not directly detect objects in the rear seat; instead, under certain conditions, it detects when a

rear door is opened and closed, indicating that there may be something in the rear seat.

The feature is active only once each time the vehicle is turned on and off, and will require reactivation by opening and closing the second row doors. There may be an alert even when there is nothing in the rear seat; for example, if a child entered the vehicle through the rear door and left the vehicle without the vehicle being shut off.

The feature can be turned on or off. Select Settings > Vehicle > Rear Seat Reminder > ON or OFF.

### **Folding the Rear Seat Cushion**

Either side of the rear seat cushion can be folded up for added cargo space.

If the vehicle is parked on a downhill grade, the seat cushion may not fold up.

#### **Caution**

Folding a rear seat with the seat belts still fastened may cause damage to the seat or the seat belts. Always unbuckle the seat belts and return them to their normal stowed position before folding a rear seat.

Make sure that nothing is on the seat cushion.



To fold the seat, slowly pull the seat cushion up.

To return the seat to the seating position, slowly pull the seat cushion down.

**Warning**

A seat belt that is improperly routed, not properly attached, or twisted will not provide the protection needed in a crash. The person wearing the belt could be seriously injured. After raising the rear

(Continued)

**Warning (Continued)**

seatback, always check to be sure that the seat belts are properly routed and attached, and are not twisted.

**Heated Rear Seats**

**Warning**

If temperature change or pain to the skin cannot be felt, the seat heater may cause burns. See the *Warning under Heated and Ventilated Front Seats* ⇨ 43.



The buttons are on the rear of the center console.

With the vehicle on, press or to heat the left or right outboard seat cushion. An indicator on the rear climate control display appears when this feature is on.

Press the button once for the highest setting. With each press of the button, the seat will change to the next lower setting, and then to the off setting. The indicator lights next to the buttons indicate three for the highest setting and one for the lowest.

If the heated seats are on high, the level will automatically lower after approximately 30 minutes.

**Remote Start Heated Seats**

If equipped, the heated seats will turn on automatically during a remote start if it is cold outside. The heated seat indicators may come on during this operation. The heated seats may cancel when the vehicle is started. These features can be manually selected with the heated seat buttons after the vehicle is turned on.

The temperature performance of an unoccupied seat may be reduced. This is normal.

To enable or disable remote start heated seats, select Settings > Vehicle > Remote Lock, Unlock, and Start > Remote Start Auto Heat Seats > ON or OFF. See *Remote Vehicle Start* ⇨ 12.

## Seat Belts

This section describes how to use seat belts properly, and some things not to do.

### Warning

Do not let anyone ride where a seat belt cannot be worn properly. In a crash, if you or your passenger(s) are not wearing seat belts, injuries can be much worse than if you are wearing seat belts. You can be seriously injured or killed by hitting things inside the vehicle harder or by being ejected from the vehicle. In addition, anyone who is not buckled up can strike other passengers in the vehicle.

It is extremely dangerous to ride in a cargo area, inside or outside of a vehicle. In a collision, passengers riding in these areas are more likely to be seriously

(Continued)

### Warning (Continued)

injured or killed. Do not allow passengers to ride in any area of the vehicle that is not equipped with seats and seat belts.

Always wear a seat belt, and check that all passenger(s) are restrained properly too.

This vehicle has indicators as a reminder to buckle the seat belts. See *Seat Belt Reminders* ⇨ 100.

### Why Seat Belts Work



When riding in a vehicle, you travel as fast as the vehicle does. If the vehicle stops suddenly, you keep going until something stops you. It could be the windshield, the instrument panel, or the seat belts!

When you wear a seat belt, you and the vehicle slow down together. There is more time to stop because you stop over a longer distance and, when worn properly, your strongest bones take the forces from the seat belts. That is why wearing seat belts makes such good sense.

### Questions and Answers About Seat Belts

**Q: Will I be trapped in the vehicle after a crash if I am wearing a seat belt?**

**A:** You *could* be — whether you are wearing a seat belt or not. Your chance of being conscious during and after a crash, so you *can* unbuckle and get out, is *much* greater if you are belted.

**Q: If my vehicle has airbags, why should I have to wear seat belts?**

**A:** Airbags are supplemental systems only. They work *with* seat belts — not instead of them. Whether or not an airbag is provided, all occupants still have to buckle up to get the most protection.

Also, in nearly all states and in all Canadian provinces, the law requires wearing seat belts.

## Buckle To Drive

If equipped, this feature delays the vehicle from shifting out of P (Park) when the driver seat belt is not buckled. The Buckle to Drive feature must be turned ON in the infotainment system to work. To turn the Buckle to Drive feature on or off, select Settings > Vehicle > Buckle to Drive. See *Teen Driver* ⇨ 150, if equipped.

If the vehicle is on and the brake pedal is pressed with the vehicle in P (Park) but the driver seat belt is not buckled, a message displays in the Driver Information Center (DIC) and the vehicle will be delayed from shifting out of P (Park). Buckle the driver seat belt to clear the message and shift out of P (Park). Shifting from P (Park) will be delayed once for each time the vehicle is started.

On some models, Buckle to Drive may also delay shifting out of P (Park) if a front passenger seat belt is unbuckled. A message displays in the DIC. Buckle the front passenger seat belt to clear the message and shift out of P (Park). This feature may

delay the vehicle from shifting out of P (Park) if an object, such as a briefcase, handbag, grocery bag, laptop, or other electronic device, is on the front passenger seat. If this happens, remove the object from the seat or buckle the seat belt to shift out of P (Park).

If the driver, or on some vehicles, the present front passenger remains unbuckled, the DIC message will turn off after several seconds and the vehicle can be shifted out of P (Park). See “Seat Belts” and “Child Restraints” in the Index for information about the importance of proper restraint use.

If the driver seat belt or the front passenger seat belt is unbuckled when driving, the seat belt reminder chime and light(s) will come on. See *Seat Belt Reminders* ⇨ 100. This feature may not function properly if the airbag readiness light is on. See *Airbag Readiness Light* ⇨ 100.

## How to Wear Seat Belts Properly

Follow these rules for everyone's protection.

There are additional things to know about seat belts and children, including smaller children and infants. If a child will be riding in the vehicle, see *Older Children* ⇨ 62 or

*Infants and Young Children* ⇨ 64. Review and follow the rules for children in addition to the following rules.

It is very important for all occupants to buckle up. Statistics show that unbelted people are hurt more often in crashes than those who are wearing seat belts.

There are important things to know about wearing a seat belt properly.

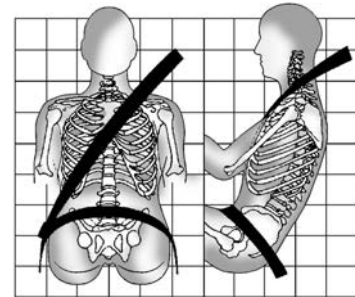

- Sit up straight and always keep your feet on the floor in front of you (if possible).
- Wear the lap part of the belt low and snug on the hips, just touching the thighs. In a crash, this applies force to the strong pelvic bones and you would be less likely to slide under the lap belt.

## 48 Seats and Restraints

If you slid under it, the belt would apply force on your abdomen. This could cause serious or even fatal injuries.

- Wear the shoulder belt over the shoulder and across the chest. These parts of the body are best able to take belt restraining forces. The shoulder belt locks if there is a sudden stop or crash.

### Warning

You can be seriously injured, or even killed, by not wearing your seat belt properly.

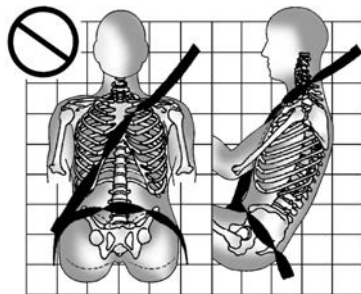
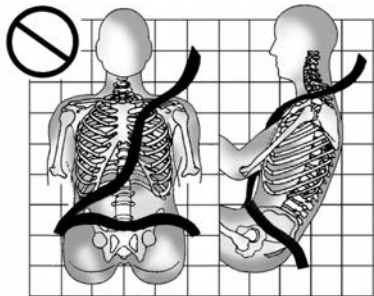

Never allow the lap or shoulder belt to become loose or twisted.

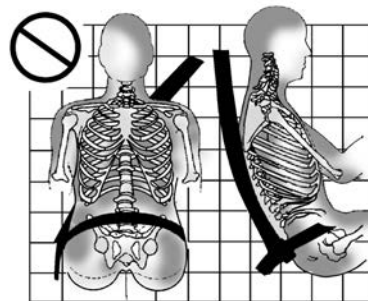
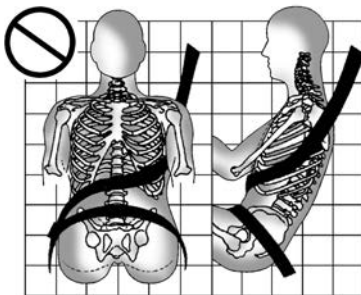

Never wear the shoulder belt under both arms or behind your back.

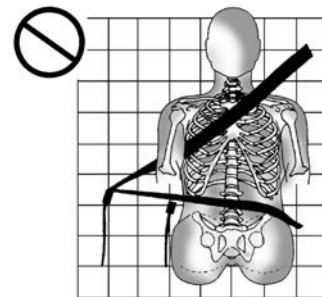

Always use the correct buckle for your seating position.

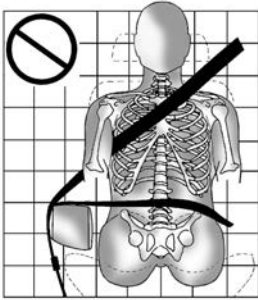

Never route the lap or shoulder belt over an armrest.

### Warning

The seat belt can be pinched if it is routed under plastic trim on the seat, such as trim around the rear seatback folding handle or side airbag. In a crash, pinched seat belts might not provide adequate protection. Never allow seat belts to be routed under plastic trim pieces.

### Warning

You can be seriously injured or killed if the shoulder belt is worn behind your back, under your legs, or wrapped around your neck. The shoulder belt can tighten but cannot be loosened if it is locked. The shoulder belt locks when it is pulled all the way out of the retractor. It unlocks when the shoulder belt is allowed to go all the way back into the retractor, but it cannot do this if it is wrapped around you. You may have to cut the seat belt if it is locked and tightened around you.

### Lap-Shoulder Belt

All seating positions in the vehicle have a lap-shoulder belt.

The following instructions explain how to wear a lap-shoulder belt properly.

1. Adjust the seat, if the seat is adjustable, so you can sit up straight. To see how, see "Seats" in the Index.

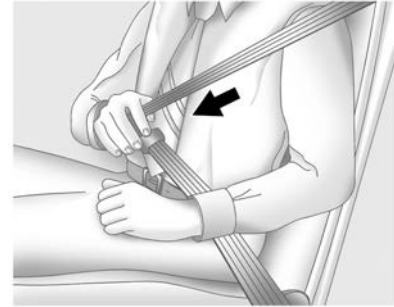

2. Pick up the latch plate and pull the belt across you. Do not let it get twisted.

The lap-shoulder belt may lock if you pull the belt across you very quickly. If this happens, let the belt go back slightly to unlock it. Then pull the belt across you more slowly.

If the shoulder portion of a passenger belt is pulled out all the way, the child restraint locking feature may be engaged. See *Child Restraint Systems* ⇨ 66. If this occurs, let the belt go back all the way and start again. If the locking feature stays engaged after letting the belt go back to the stowed

position on the seat, move the seat rearward or recline the seat until the shoulder belt retractor lock releases.

Engaging the child restraint locking feature in the front outboard seating position may affect the passenger sensing system. See *Passenger Sensing System* ⇨ 57.



3. If the webbing locks in the latch plate before it reaches the buckle, tilt the latch plate flat to unlock.

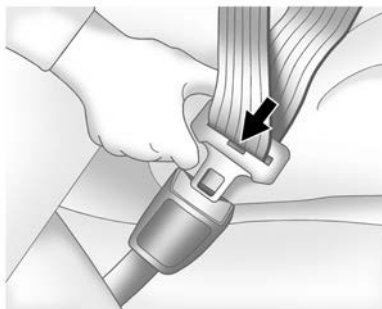

4. Push the latch plate into the buckle until it clicks.

Pull up on the latch plate to make sure it is secure.

If the belt is not long enough, see *Seat Belt Extender* ⇨ 52.

Position the release button on the buckle so that the seat belt could be quickly unbuckled if necessary.

5. If equipped with a shoulder belt height adjuster, move it to the height that is right for you. See “Shoulder Belt Height Adjuster” in this section for instructions on use and important safety information.



6. To make the lap part tight, pull up on the shoulder belt.



To unlatch the belt, push the button on the buckle. The belt should return to its stowed position.

Always stow the seat belt slowly. If the seat belt webbing returns quickly to the stowed position, the retractor may lock and cannot be pulled out. If this happens, pull the seat belt straight out firmly to unlock the webbing, and then release it. If the webbing is still locked in the retractor, see your dealer.

Before a door is closed, be sure the seat belt is out of the way. If a door is slammed against a seat belt, damage can occur to both the seat belt and the vehicle.

### Shoulder Belt Height Adjuster

The vehicle has a shoulder belt height adjuster for the driver and front outboard passenger positions.

Adjust the height so the shoulder portion of the belt is on the shoulder and not falling off of it. The belt should be close to, but not contacting, the neck. Improper shoulder belt height adjustment could reduce the effectiveness of the seat belt in a crash. See *How to Wear Seat Belts Properly* ⇨ 47.



Push the release button to move the height adjuster to the desired position.

After the adjuster is set to the desired position, try to move it down without pushing the release button to make sure it has locked into position.

### Seat Belt Pretensioners

This vehicle has seat belt pretensioners for the front outboard occupants.

Although the seat belt pretensioners cannot be seen, they are part of the seat belt assembly. They can help tighten the seat belts during the early stages of a moderate to severe frontal, near frontal, or rear crash if the threshold conditions for pretensioner activation are met.

Seat belt pretensioners can also help tighten the seat belts in a side crash or rollover event.

Pretensioners work only once. If the pretensioners activate in a crash, the pretensioners and probably other parts of the vehicle's seat belt system will need to be replaced. See *Replacing Seat Belt System Parts after a Crash* ⇨ 53.

Do not sit on the outboard seat belt while entering or exiting the vehicle or at any time while sitting in the seat. Sitting on the seat belt can damage the webbing and hardware.

### Rear Seat Belt Comfort Guides

Rear seat belt comfort guides may provide added seat belt comfort for older children who have outgrown booster seats and for some adults. When installed on a shoulder belt, the comfort guide positions the shoulder belt away from the neck and head.

Comfort guides are available through your dealer for the rear outboard seating positions. Instructions are included with the comfort guides.



## Seat Belt Use During Pregnancy

Seat belts work for everyone, including pregnant women. Like all occupants, they are more likely to be seriously injured if they do not wear seat belts.



A pregnant woman should wear a lap-shoulder belt, and the lap portion should be worn as low as possible, below the rounding, throughout the pregnancy.

The best way to protect the fetus is to protect the mother. When a seat belt is worn properly, it is more likely that the fetus will not be hurt in a crash. For pregnant women, as for anyone, the key to making seat belts effective is wearing them properly.

## Seat Belt Extender

If the vehicle's seat belt will fasten around you, you should use it.

But if a seat belt is not long enough, your dealer will order you an extender. Only a GM dealer issued extender should be used. When you go in to order it, take the heaviest coat you will wear, so the extender will be long enough for you. To help avoid personal injury, do not let someone else use it, and use it only for the seat it is made to fit. The extender has been designed for adults. Never use it for securing child restraints. For more information on the proper use and fit of seat belt extenders see the instruction sheet that comes with the extender.

## Safety System Check

Periodically check the seat belt reminder, seat belts, buckles, latch plates, retractors, shoulder belt height adjusters (if equipped), and seat belt anchorages to make sure they are all in working order. Look for any other loose or damaged seat belt system parts that might keep a seat belt system from performing properly. See your dealer to have it repaired. Torn, frayed, or twisted seat belts may not protect you in a crash.

Torn or frayed seat belts can rip apart under impact forces. If a belt is torn or frayed, have it replaced immediately. If a belt is twisted, it may be possible to untwist by reversing the latch plate on the webbing. If the twist cannot be corrected, ask your dealer to fix it.

Make sure the seat belt reminder light is working. See *Seat Belt Reminders* ⇨ 100.

Keep seat belts clean and dry. See *Seat Belt Care* ⇨ 52.

## Seat Belt Care

Keep belts clean and dry.

Seat belts should be properly cared for and maintained.

Seat belt hardware should be kept dry and free of dust or debris. As necessary, exterior hard surfaces and seat belt webbing may be lightly cleaned with mild soap and water. Ensure there is not excessive dust or debris in the mechanism. If dust or debris exists in the system please see the dealer. Parts may need to be replaced to ensure proper functionality of the system.

 **Warning**

Do not bleach or dye seat belt webbing. It may severely weaken the webbing. In a crash, they might not be able to provide adequate protection. Clean and rinse seat belt webbing only with mild soap and lukewarm water. Allow the webbing to dry.

## Replacing Seat Belt System Parts after a Crash

 **Warning**

A crash can damage the seat belt system in the vehicle. A damaged seat belt system may not properly protect the person using it, resulting in serious injury or even death in a crash. To help make sure the seat belt systems are working properly after a crash, have them inspected and any necessary replacements made as soon as possible.

After a minor crash, replacement of seat belts may not be necessary. But the seat belt assemblies that were used during any

crash may have been stressed or damaged. See your dealer to have the seat belt assemblies inspected or replaced.

New parts and repairs may be necessary even if the seat belt system was not being used at the time of the crash.

Have the seat belt pretensioners checked if the vehicle has been in a crash, or if the airbag readiness light stays on after you start the vehicle or while you are driving. See *Airbag Readiness Light* ⇨ 100.

## Airbag System

The vehicle has the following airbags:

- A frontal airbag for the driver
- A frontal airbag for the front outboard passenger
- A seat-mounted side impact airbag for the driver
- A seat-mounted side impact airbag for the front outboard passenger

All vehicle airbags have the word AIRBAG on the trim or on a label near the deployment opening.

For frontal airbags, the word AIRBAG is on the center of the steering wheel for the driver and on the instrument panel for the front outboard passenger.

For seat-mounted side impact airbags, the word AIRBAG is on the side of the seatback or side of the seat closest to the door.

Airbags are designed to supplement the protection provided by seat belts. Even though today's airbags are also designed to help reduce the risk of injury from the force of an inflating bag, all airbags must inflate very quickly to do their job.

Here are the most important things to know about the airbag system:

 **Warning**

You can be severely injured or killed in a crash if you are not wearing your seat belt, even with airbags. Airbags are designed to work with seat belts, not replace them. Also, airbags are not designed to inflate in every crash. In some crashes seat belts are the only restraint. See *When Should an Airbag Inflate?* ⇨ 55.

(Continued)

**Warning (Continued)**

Wearing your seat belt during a crash helps reduce your chance of hitting things inside the vehicle or being ejected from it. Airbags are “supplemental restraints” to the seat belts. Everyone in the vehicle should wear a seat belt properly, whether or not there is an airbag for that person.

**⚠ Warning**

Because airbags inflate with great force and faster than the blink of an eye, anyone who is up against, or very close to, any airbag when it inflates can be seriously injured or killed. Do not sit unnecessarily close to any airbag, as you would be if sitting on the edge of the seat or leaning forward. Seat belts help keep you in position before and during a crash. Always wear the seat belt, even with airbags. The driver should sit as far back as possible while still maintaining control of the vehicle. The seat belts and the front outboard passenger airbags are  
(Continued)

**Warning (Continued)**

most effective when you are sitting well back and upright in the seat with both feet on the floor.

Occupants should not lean on or sleep against the door or side windows in seating positions with seat-mounted airbags.

**⚠ Warning**

Children who are up against, or very close to, any airbag when it inflates can be seriously injured or killed. Always secure children properly in the vehicle. To read how, see *Older Children* ⇨ 62 or *Infants and Young Children* ⇨ 64.



There is an airbag readiness light on the instrument cluster, which shows the airbag symbol.

The system checks the airbag electrical system for malfunctions. The light tells you if there is an electrical problem. See *Airbag Readiness Light* ⇨ 100.

**Where Are the Airbags?**

The driver frontal airbag is in the center of the steering wheel.



The front outboard passenger frontal airbag is in the passenger side instrument panel.



Driver Side Shown, Passenger Side Similar

The driver and front outboard passenger seat-mounted side impact airbags are in the side of the seatbacks closest to the door.

### Warning

If something is between an occupant and an airbag, the airbag might not inflate properly or it might force the object into that person causing severe injury or even death. The path of an inflating airbag must be kept clear. Do not put anything between an occupant and an airbag, and do not attach or put anything on the steering wheel hub or on or near any other airbag covering.

Do not use seat accessories that block the inflation path of a seat-mounted side impact airbag.

### When Should an Airbag Inflate?

This vehicle is equipped with airbags. See *Airbag System* ⇨ 53. Airbags are designed to inflate if the impact exceeds the specific airbag system's deployment threshold. Deployment thresholds are used to predict how severe a crash is likely to be in time for the airbags to inflate and help restrain the occupants. The vehicle has electronic

sensors that help the airbag system determine the severity of the impact. Deployment thresholds can vary with specific vehicle design.

Frontal airbags are designed to inflate in moderate to severe frontal crashes to help reduce the potential for severe injuries, mainly to the driver's or front outboard passenger's head and chest.

Whether the frontal airbags will or should inflate is not based primarily on how fast the vehicle is traveling. It depends on what is hit, the direction of the impact, and how quickly the vehicle slows down.

Frontal airbags may inflate at different crash speeds depending on whether the vehicle hits an object straight on or at an angle, and whether the object is fixed or moving, rigid or deformable, narrow or wide.

Frontal airbags are not intended to inflate during vehicle rollovers, rear impacts, or many side impacts.

In addition, the vehicle has advanced technology frontal airbags. Advanced technology frontal airbags adjust the restraint according to crash severity.

Seat-mounted side impact airbags are designed to inflate in moderate to severe side crashes depending on the location of the impact. These airbags may also inflate in some moderate to severe frontal impacts. Seat-mounted side impact airbags are not designed to inflate in rollovers or rear impacts. A seat-mounted side impact airbag is designed to inflate on the side of the vehicle that is struck.

In any particular crash, no one can say whether an airbag should have inflated simply because of the vehicle damage or the repair costs.

### What Makes an Airbag Inflate?

In a deployment event, the sensing system sends an electrical signal triggering a release of gas from the inflator. Gas from the inflator fills the airbag causing the bag to break out of the cover. The inflator, the airbag, and related hardware are all part of the airbag module.

For airbag locations, see *Where Are the Airbags?* ⇨ 54.

### How Does an Airbag Restrain?

In moderate to severe frontal or near frontal collisions, even belted occupants can contact the steering wheel or the instrument panel. In moderate to severe side collisions, even belted occupants can contact the inside of the vehicle.

Airbags supplement the protection provided by seat belts by distributing the force of the impact more evenly over the occupant's body.

But airbags would not help in many types of collisions, primarily because the occupant's motion is not toward those airbags. See *When Should an Airbag Inflate?* ⇨ 55.

Airbags should never be regarded as anything more than a supplement to seat belts.

### What Will You See after an Airbag Inflates?

After frontal and seat-mounted side impact airbags inflate, they quickly deflate, so quickly that some people may not even realize the airbags inflated. Some

components of the airbag module may be hot for several minutes. For location of the airbags, see *Where Are the Airbags?* ⇨ 54.

The parts of the airbag that come into contact with you may be warm, but not too hot to touch. There may be some smoke and dust coming from the vents in the deflated airbags. Airbag inflation does not prevent the driver from seeing out of the windshield or being able to steer the vehicle, nor does it prevent people from leaving the vehicle.

#### Warning

When an airbag inflates, there may be dust in the air. This dust could cause breathing problems for people with a history of asthma or other breathing trouble. To avoid this, everyone in the vehicle should get out as soon as it is safe to do so. If you have breathing problems but cannot get out of the vehicle after an airbag inflates, then get fresh air by opening a window or a door. If you experience breathing problems following an airbag deployment, you should seek medical attention.

The vehicle has a feature that may automatically unlock the doors, turn on the interior lamps and hazard warning flashers after the airbags inflate. The feature may also activate, without airbag inflation, after an event that exceeds a predetermined threshold. After turning the vehicle off and then on again, the doors can be locked, the interior lamps can be turned off, and the hazard warning flashers can be turned off using the controls for those features. If any of these systems are damaged in the crash they may not operate as normal.

 **Warning**

A crash severe enough to inflate the airbags may have also damaged important functions in the vehicle, such as the brake and steering systems, etc. Even if the vehicle appears to be drivable after a moderate crash, there may be concealed damage that could make it difficult to safely operate the vehicle.

Use caution if attempting to restart the vehicle after a crash has occurred.

Plug-in vehicles have a high voltage battery and a standard 12-volt battery.

If an airbag inflates or the vehicle has been in a crash, the sensing system may shut down the high voltage system. When this occurs, the high voltage battery is disconnected and the vehicle will not start. Before the vehicle can be operated again, it must be serviced at your dealer.

In many crashes severe enough to inflate the airbag, windshields are broken by vehicle deformation. Additional windshield breakage may also occur from the front outboard passenger airbag.

- Airbags are designed to inflate only once. After an airbag inflates, you will need some new parts for the airbag system. If you do not get them, the airbag system will not be there to help protect you in another crash. A new system will include airbag modules and possibly other parts. The service manual for the vehicle covers the need to replace other parts.
- The vehicle has a crash sensing and diagnostic module which records information after a crash. See *Vehicle Data Recording and Privacy* ⇨ 375 and *Event Data Recorders* ⇨ 376.

- Let only qualified technicians work on the airbag system. Improper service can mean that an airbag system will not work properly. See your dealer for service.

### Passenger Sensing System

The vehicle has a passenger sensing system for the front outboard passenger position. The passenger airbag status indicator will light on the overhead console when the vehicle is started.



United States



Canada

The words ON and OFF, or the symbols for on and off, will be visible during the system check. When the system check is complete, either the word ON or OFF, or the symbol for on and off, will be visible. See *Passenger Airbag Status Indicator* ⇨ 101.

The passenger sensing system turns off the front outboard passenger frontal airbag under certain conditions. No other airbag is affected by the passenger sensing system.

The passenger sensing system works with sensors that are part of the front outboard passenger seat and seat belt. The sensors are designed to detect the presence of a properly seated occupant and determine if the front outboard passenger frontal airbag should be allowed to inflate or not.

According to accident statistics, children are safer when properly secured in a rear seat in the correct child restraint for their weight and size.

Whenever possible, children aged 12 and under should be secured in a rear seating position.

Never put a rear-facing child seat in the front. This is because the risk to the rear-facing child is so great, if the airbag inflates.

### Warning

A child in a rear-facing child restraint can be seriously injured or killed if the passenger frontal airbag inflates. This is because the back of the rear-facing child restraint would be very close to the inflating airbag. A child in a forward-facing child restraint can be seriously injured or killed if the passenger frontal airbag inflates and the passenger seat is in a forward position.

Even if the passenger sensing system has turned off the passenger frontal airbag, no system is fail-safe. No one can guarantee that an airbag will not deploy under some unusual circumstance, even though the airbag is turned off.

Never put a rear-facing child restraint in the front seat, even if the airbag is off. If securing a forward-facing child restraint in the front outboard passenger seat, always move the seat as far back as it will go. It is better to secure child restraints in the rear seat. Consider using another vehicle to transport the child when a rear seat is not available.

The passenger sensing system is designed to turn off the front outboard passenger frontal airbag if:

- The front outboard passenger seat is unoccupied.
- The system determines an infant is present in a child restraint.
- A front outboard passenger takes his/her weight off of the seat for a period of time.

When the passenger sensing system has turned off the front outboard passenger frontal airbag, the OFF indicator will light and stay lit as a reminder that the airbag is off. See *Passenger Airbag Status Indicator* ⇨ 101.

The passenger sensing system is designed to turn on the front outboard passenger frontal airbag anytime the system senses that a person of adult size is sitting properly in the front outboard passenger seat.

When the passenger sensing system has allowed the airbag to be enabled, the ON indicator will light and stay lit as a reminder that the airbag is active.

For some children, including children in child restraints, and for very small adults, the passenger sensing system may or may not

turn off the front outboard passenger frontal airbag, depending upon the person's seating posture and body build. Everyone in the vehicle who has outgrown child restraints should wear a seat belt properly — whether or not there is an airbag for that person.

### Warning

If the airbag readiness light ever comes on and stays on, it means that something may be wrong with the airbag system. To help avoid injury to yourself or others, have the vehicle serviced right away. See *Airbag Readiness Light* ⇨ 100 for more information, including important safety information.

### If the On Indicator Is Lit for a Child Restraint

The passenger sensing system is designed to turn off the front outboard passenger frontal airbag if the system determines that an infant is present in a child restraint. If a child restraint has been installed and the ON indicator is lit:

1. Turn the vehicle off.

2. Remove the child restraint from the vehicle.
3. Remove any additional items from the seat such as blankets, cushions, seat covers, seat heaters, or seat massagers.
4. Reinstall the child restraint following the directions provided by the child restraint manufacturer and refer to *Securing Child Restraints (With the Seat Belt in the Rear Seat)* ⇨ 77 or *Securing Child Restraints (With the Seat Belt in the Front Seat)* ⇨ 79.

Make sure the seat belt retractor is locked by pulling the shoulder belt all the way out of the retractor when installing the child restraint, even if the child restraint is equipped with a seat belt lock off. When the retractor lock is set, the belt can be tightened but not pulled out of the retractor.

5. If, after reinstalling the child restraint and restarting the vehicle, the ON indicator is still lit, turn the vehicle off. Then slightly recline the vehicle seatback and adjust the seat cushion, if adjustable, to make sure that the vehicle seatback is not pushing the child restraint into the seat cushion.

Also make sure the child restraint is not trapped under the vehicle head restraint. If this happens, adjust the head restraint. See *Head Restraints* ⇨ 37.

6. Restart the vehicle.

The passenger sensing system may or may not turn off the airbag for a child in a child restraint depending upon the child's size. It is better to secure child restraints in a rear seat. Consider using another vehicle to transport the child when a rear seat is not available. Never put a rear-facing child restraint in the front seat, even if the ON indicator is not lit.



### If the Off Indicator Is Lit for an Adult-Sized Occupant



If a person of adult size is sitting in the front outboard passenger seat, but the OFF indicator is lit, it could be because that person is not sitting properly in the seat or that the child restraint locking feature is engaged. Use the following steps to allow the system to detect that person and enable the front outboard passenger frontal airbag:

1. Turn the vehicle off.
2. Remove any additional material from the seat, such as blankets, cushions, seat covers, seat heaters, or seat massagers.
3. Place the seatback in the fully upright position.

4. Have the person sit upright in the seat, centered on the seat cushion, with legs comfortably extended.
5. If the shoulder portion of the belt is pulled out all the way, the child restraint locking feature will be engaged. This may unintentionally cause the passenger sensing system to turn the airbag off for some adult-sized occupants. If this happens, unbuckle the belt, let the belt go back all the way, and then buckle the belt again without pulling the belt out all the way.
6. Restart the vehicle and have the person remain in this position for two to three minutes after the ON indicator is lit.

#### Warning

If the front outboard passenger airbag is turned off for an adult-sized occupant, the airbag will not be able to inflate and help protect that person in a crash, resulting in an increased risk of serious injury or even death. An adult-sized occupant should not ride in the front outboard passenger seat, if the passenger airbag OFF indicator is lit.

### Additional Factors Affecting System Operation

Seat belts help keep the passenger in position on the seat during vehicle maneuvers and braking, which helps the passenger sensing system maintain the passenger airbag status. See “Seat Belts” and “Child Restraints” in the Index for additional information about the importance of proper restraint use.

A thick layer of additional material, such as a blanket or cushion, or aftermarket equipment such as seat covers, seat heaters, and seat massagers can affect how well the passenger sensing system operates. We recommend that you not use seat covers or other aftermarket equipment except when approved by GM for your specific vehicle. See *Adding Equipment to the Airbag-Equipped Vehicle* ⇨ 61 for more information about modifications that can affect how the system operates.

The ON indicator may be lit if an object, such as a briefcase, handbag, grocery bag, laptop, or other electronic device, is put on an unoccupied seat. If this is not desired, remove the object from the seat.

 **Warning**

Stowing articles under the passenger seat or between the passenger seat cushion and seatback may interfere with the proper operation of the passenger sensing system.

## Servicing the Airbag-Equipped Vehicle

Airbags affect how the vehicle should be serviced. There are parts of the airbag system in several places around the vehicle. Your dealer and the service manual have information about servicing the vehicle and the airbag system. To purchase a service manual, see *Publication Ordering Information* ⇨ 373.

 **Warning**

For up to 10 seconds after the vehicle is turned off and the battery is disconnected, an airbag can still inflate during improper service. You can be injured if you are close to an airbag when it inflates. Avoid yellow connectors. They are probably part of the airbag

(Continued)

**Warning (Continued)**

system. Be sure to follow proper service procedures, and make sure the person performing work for you is qualified to do so.

## Adding Equipment to the Airbag-Equipped Vehicle

Adding accessories that change the vehicle's frame, bumper system, height, front end, or side sheet metal may keep the airbag system from working properly.

The operation of the airbag system can also be affected by changing, including improperly repairing or replacing, any parts of the following:

- Airbag system, including airbag modules, front or side impact sensors, sensing and diagnostic module, airbag wiring
- Front seats, including stitching, seams or zippers
- Seat belts
- Steering wheel, instrument panel, overhead console, ceiling trim, or pillar garnish trim
- Inner door seals, including speakers

Your dealer and the service manual have information about the location of the airbag modules and sensors, sensing and diagnostic module, and airbag wiring along with the proper replacement procedures.

In addition, the vehicle has a passenger sensing system for the front outboard passenger position, which includes sensors that are part of the passenger's seat. The passenger sensing system may not operate properly if the original seat trim is replaced with non-GM covers, upholstery, or trim, or with GM covers, upholstery, or trim designed for a different vehicle. Any object, such as an aftermarket seat heater or a comfort enhancing pad or device, installed under or on top of the seat fabric, could also interfere with the operation of the passenger sensing system. This could either prevent proper deployment of the passenger airbag(s) or prevent the passenger sensing system from properly turning off the passenger airbag(s). See *Passenger Sensing System* ⇨ 57.

If the vehicle must be modified because you have a disability and you have questions about whether the modifications will affect the vehicle's airbag system, or if you have questions about whether the airbag system

will be affected if the vehicle is modified for any other reason, call Customer Assistance. See *Customer Assistance Offices* ⇨ 368.

### Airbag System Check

The airbag system does not need regularly scheduled maintenance or replacement. Make sure the airbag readiness light is working. See *Airbag Readiness Light* ⇨ 100.

#### Caution

If an airbag covering is damaged, opened, or broken, the airbag may not work properly. Do not open or break the airbag coverings. If there are any opened or broken airbag coverings, have the airbag covering and/or airbag module replaced. For the location of the airbags, see *Where Are the Airbags?* ⇨ 54. See your dealer for service.

### Replacing Airbag System Parts after a Crash

#### Warning

A crash can damage the airbag systems in the vehicle. A damaged airbag system may not properly protect you and your passenger(s) in a crash, resulting in serious injury or even death. To help make sure the airbag systems are working properly after a crash, have them inspected and any necessary replacements made as soon as possible.

If an airbag inflates, you will need to replace airbag system parts. See your dealer for service.

If the airbag readiness light stays on after the vehicle is started or comes on when you are driving, the airbag system may not work properly. Have the vehicle serviced right away. See *Airbag Readiness Light* ⇨ 100.

### Child Restraints

#### Older Children

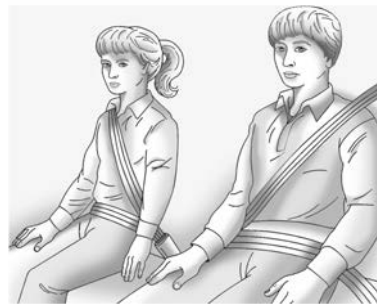

Older children who have outgrown booster seats should wear the vehicle's seat belts. Refer to *How to Wear Seat Belts Properly* ⇨ 47.

The manufacturer instructions that come with the booster seat state the weight and height limitations for that booster. Use a booster seat with a lap-shoulder belt until the child passes the fit test below:

- Sit all the way back on the seat. Do the knees bend at the seat edge? If yes, continue. If no, return to the booster seat.

- Buckle the lap-shoulder belt. Does the shoulder belt rest on the shoulder? If yes, continue. If no, try using the rear seat belt comfort guide, if available. See “Rear Seat Belt Comfort Guides” under *Lap-Shoulder Belt* ⇨ 49. If a comfort guide is not available, or if the shoulder belt still does not rest on the shoulder, then return to the booster seat.
- Does the lap belt fit low and snug on the hips, touching the thighs? If yes, continue. If no, return to the booster seat.
- Can proper seat belt fit be maintained for the length of the trip? If yes, continue. If no, return to the booster seat.

**Q: What is the proper way to wear seat belts?**

**A:** An older child should wear a lap-shoulder belt and get the additional restraint a shoulder belt can provide. The shoulder belt should not cross the face or neck. The lap belt should fit snugly below the hips, just touching the top of the thighs. This applies belt force to the child's pelvic bones in a crash. It should never be worn over the abdomen, which could cause severe or even fatal internal injuries in a crash.

Also see “Rear Seat Belt Comfort Guides” under *Lap-Shoulder Belt* ⇨ 49.

According to accident statistics, children are safer when properly restrained in a rear seating position.

In a crash, children who are not buckled up can strike other people who are buckled up, or can be thrown out of the vehicle. Older children need to use seat belts properly.

**⚠ Warning**

Never allow more than one child to wear the same seat belt. The seat belt cannot properly spread the impact forces. In a crash, they can be crushed together and seriously injured. A seat belt must be used by only one person at a time.

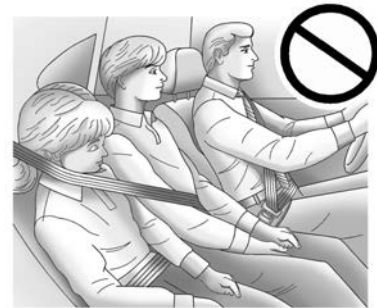

**⚠ Warning**

Never allow a child to wear the seat belt shoulder belt under both arms or behind their back. A child can be seriously injured by not wearing the lap-shoulder belt properly. In a crash, the child would not be restrained by the shoulder belt. The child could move too far forward increasing the chance of head and neck injury. The child might also slide under the lap belt. The belt force would then be applied right on the abdomen. That could cause serious or fatal injuries. The shoulder belt should go over the shoulder and across the chest.



## Infants and Young Children

Everyone in a vehicle needs protection! This includes infants and all other children. Neither the distance traveled nor the age and size of the traveler changes the need, for everyone, to use safety restraints. In fact, the law in every state in the United States and in every Canadian province says children up to some age must be restrained while in a vehicle.

### Warning

Children can be seriously injured or killed if the shoulder belt is worn behind their back, under their legs, or wrapped around  
(Continued)

### Warning (Continued)

their neck. The shoulder belt can tighten but cannot be loosened if it is locked. The shoulder belt locks when it is pulled all the way out of the retractor. It unlocks when the shoulder belt is allowed to go all the way back into the retractor, but it cannot do this if it is wrapped around the child. Never leave children unattended in a vehicle and never allow children to improperly wear, or play with, the seat belts.

Every time infants and young children ride in vehicles, they should have the protection provided by appropriate child restraints. Neither the vehicle's seat belt system nor its airbag system is designed for them.

Children who are not restrained properly can strike other people, or can be thrown out of the vehicle.

### Warning

Never hold an infant or a child while riding in a vehicle. Due to crash forces, an infant or a child will become so heavy it  
(Continued)

### Warning (Continued)

is not possible to hold it during a crash. For example, in a crash at only 40 km/h (25 mph), a 5.5 kg (12 lb) infant will suddenly become a 110 kg (240 lb) force on a person's arms. An infant or child should be secured in an appropriate child restraint.



### Warning

Children who are up against, or very close to, any airbag when it inflates can be seriously injured or killed. Never put a rear-facing child restraint in the front  
(Continued)

**Warning (Continued)**

outboard seat. Secure a rear-facing child restraint in a rear seat. It is also better to secure a forward-facing child restraint in a rear seat. If you must secure a forward-facing child restraint in the front outboard seat, always move the front passenger seat as far back as it will go.



Child restraints are devices used to restrain, seat, or position children in the vehicle and are sometimes called child seats or car seats.

**There are three basic types of child restraints:**

- Forward-facing child restraints

- Rear-facing child restraints
- Belt-positioning booster seats

The proper child restraint for your child depends on their size, weight, and age, and also on whether the child restraint is compatible with the vehicle in which it will be used.

For each type of child restraint, there are many different models available. When purchasing a child restraint, be sure it is designed to be used in a motor vehicle and is designed by a genuine child restraint manufacturer. If it is, the child restraint will have a label saying that it meets federal motor vehicle safety standards.

The instruction manual that is provided with the child restraint states the weight and height limitations for that particular child restraint. In addition, there are many kinds of child restraints available for children with special needs.

**Warning**

To reduce the risk of neck and head injury in a crash, infants and toddlers should be secured in a rear-facing child  
(Continued)

**Warning (Continued)**

restraint until age two, or until they reach the maximum height and weight limits of their child restraint.

**Warning**

A young child's hip bones are still so small that the vehicle seat belt may not remain low on the hip bones, as it should. Instead, it may settle up around the child's abdomen. In a crash, the belt would apply force on a body area that is unprotected by any bony structure. This alone could cause serious or fatal injuries. To reduce the risk of serious or fatal injuries during a crash, young children should always be secured in an appropriate child restraint.

## Child Restraint Systems



### Rear-Facing Infant Restraint

A rear-facing child restraint provides restraint with the seating surface against the back of the infant.

The harness system holds the infant in place and, in a crash, acts to keep the infant positioned in the restraint.



### Forward-Facing Child Restraint

A forward-facing child restraint provides restraint for the child's body with the harness.

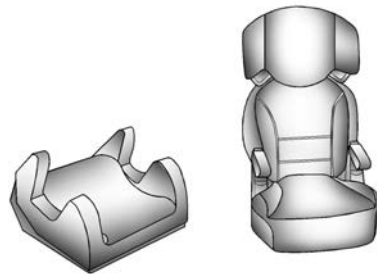

### Booster Seats

A belt-positioning booster seat is used for children who have outgrown their forward-facing child restraint. Boosters are designed to improve the fit of the vehicle's seat belt system until the child is large enough for the vehicle seat belts to fit properly without a booster seat. See the seat belt fit test in *Older Children* ⇨ 62.

## Securing an Add-On Child Restraint in the Vehicle

### Warning

A child can be seriously injured or killed in a crash if the child restraint is not properly secured in the vehicle. Secure the child restraint properly in the vehicle using the vehicle seat belt or LATCH system, following the instructions that came with that child restraint and the instructions in this manual.

To help reduce the chance of injury, the child restraint must be secured in the vehicle. Child restraints must be secured in vehicle seats by lap belts or the lap belt portion of a lap-shoulder belt, or by the LATCH system. See *Lower Anchors and Tethers for Children (LATCH System)* ⇨ 69 for more information. Never use a seat belt extender when installing a child restraint. Never use non-regulated aftermarket anchors or attachments to secure a child restraint. Children can be endangered in a crash if the child restraint is not properly secured in the vehicle.

When securing an add-on child restraint, refer to the following:

1. Instruction labels provided on the child restraint
2. Instruction manual provided with the child restraint
3. This vehicle owner's manual

The child restraint instructions are important, so if they are not available, obtain a replacement copy from the manufacturer.

Keep in mind that an unsecured child restraint can move around in a collision or sudden stop and injure people in the vehicle. Be sure to properly secure any child restraint in the vehicle — even when no child is in it.

In some areas Certified Child Passenger Safety Technicians (CPSTs) are available to inspect and demonstrate how to correctly use and install child restraints. In the U.S., refer to the National Highway Traffic Safety Administration (NHTSA) website to locate the nearest child safety seat inspection station. For CPST availability in Canada, check with Transport Canada or the Provincial Ministry of Transportation office.

## Securing the Child Within the Child Restraint

### Warning

A child can be seriously injured or killed in a crash if the child is not properly secured in the child restraint. Secure the child properly following the instructions that came with that child restraint.

## Where to Put the Restraint

According to accident statistics, children and infants are safer when properly restrained in an appropriate child restraint secured in a rear seating position.

Whenever possible, children aged 12 and under should be secured in a rear seating position.

Never put a rear-facing child restraint in the front. This is because the risk to the rear-facing child is so great if the airbag deploys.



 **Warning**

A child in a rear-facing child restraint can be seriously injured or killed if the front passenger airbag inflates. This is because the back of the rear-facing child restraint would be very close to the inflating airbag. A child in a forward-facing child restraint can be seriously injured or killed if the front passenger airbag inflates and the passenger seat is in a forward position.

Even if the passenger sensing system has turned off the front passenger frontal airbag, no system is fail-safe. No one can guarantee that an airbag will not deploy under some unusual circumstance, even though it is turned off.

Secure rear-facing child restraints in a rear seat, even if the airbag is off. If you secure a forward-facing child restraint in the front seat, always move the front passenger seat as far back as it will go. It is better to secure the child restraint in a rear seat.

See *Passenger Sensing System* ⇨ 57 for additional information.

When securing a child restraint with the seat belts in a rear seat position, study the instructions that came with the child restraint to make sure it is compatible with this vehicle.

Child restraints and booster seats vary considerably in size, and some may fit in certain seating positions better than others. Do not install a child restraint in any rear seating position where it cannot be installed securely.

Depending on where you place the child restraint and the size of the child restraint, you may not be able to access adjacent seat belts or LATCH anchors for additional passengers or child restraints. Adjacent seating positions should not be used if the child restraint prevents access to or interferes with the routing of the seat belt.

The seat in front of an installed child restraint should be adjusted to ensure proper installation according to the child restraint manual.

When installing a child restraint in an adjustable second row seating position, the seat should be adjusted fore or aft to ensure proper installation according to the child restraint manual.

Wherever a child restraint is installed, be sure to follow the instructions that came with the child restraint and secure the child restraint properly.

Keep in mind that an unsecured child restraint can move around in a collision or sudden stop and injure people in the vehicle. Be sure to properly secure any child restraint in the vehicle — even when no child is in it.

## Lower Anchors and Tethers for Children (LATCH System)

The LATCH system secures a child restraint during driving or in a crash. LATCH attachments on the child restraint are used to attach the child restraint to the anchors in the vehicle. This system is designed to make installation of a child restraint easier.

In order to use the LATCH system in your vehicle, you need a child restraint that has LATCH attachments. LATCH-compatible rear-facing and forward-facing child seats can be properly installed using either the LATCH anchors or the vehicle's seat belts. Do not use both the seat belts and the LATCH anchorage system to secure a rear-facing or forward-facing child restraint.

Booster seats use the vehicle's seat belts to secure the child and the booster seat. If the manufacturer recommends that the booster seat be secured with the LATCH system, this can be done as long as the booster seat can be positioned properly and there is no interference with the proper positioning of the lap-shoulder belt on the child.

Make sure to follow the instructions that came with the child restraint, and also the instructions in this manual.

When installing a child restraint with a top tether, you must also use either the lower anchors or the seat belts to properly secure the child restraint. A child restraint must never be installed using only the top tether.

For a forward-facing 5-pt harness child restraint where the combined weight of the child and restraint are up to 29.5 kg (65 lb), use either the lower LATCH anchorages with the top tether anchorage, or the seat belt with the top tether anchorage. Where the combined weight of the child and restraint are greater than 29.5 kg (65 lb), use the seat belt with the top tether anchorage only.

## Recommended Methods for Attaching Child Restraints

Restraint Type	Combined Weight of the Child + Child Restraint	Use Only Approved Attachment Methods Shown with an X			
		LATCH – Lower Anchors Only	Seat Belt Only	LATCH – Lower Anchors and Top Tether Anchor	Seat Belt and Top Tether Anchor
Rear-Facing Child Restraint	Up to 29.5 kg (65 lb)	X	X		
Rear-Facing Child Restraint	Greater than 29.5 kg (65 lb)		X		
Forward-Facing Child Restraint	Up to 29.5 kg (65 lb)			X	X
Forward-Facing Child Restraint	Greater than 29.5 kg (65 lb)				X

See *Securing Child Restraints (With the Seat Belt in the Rear Seat)* ⇨ 77 or *Securing Child Restraints (With the Seat Belt in the Front Seat)* ⇨ 79.

Child restraints built after March 2014 are labeled with the maximum child weight, with which the LATCH system can be used for installing the child restraint.

The following explains how to attach a child restraint with these attachments in the vehicle.

Not all vehicle seating positions have lower anchors. In this case, the seat belt must be used (with top tether where available) to secure the child restraint. See *Securing Child Restraints (With the Seat Belt in the Rear Seat)* ⇨ 77 or *Securing Child Restraints (With the Seat Belt in the Front Seat)* ⇨ 79.

## Lower Anchors

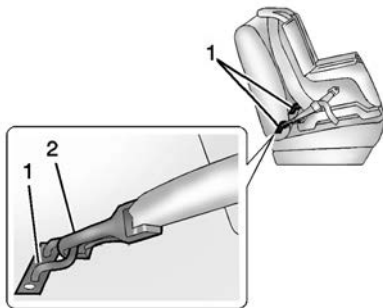

Lower anchors (1) are metal bars built into the vehicle. There are two lower anchors for each LATCH seating position that will accommodate a child restraint with lower attachments (2).

## Top Tether Anchor

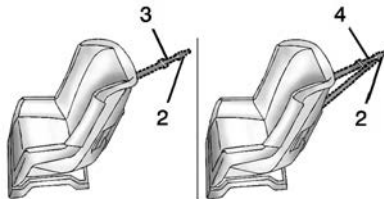

A top tether (3, 4) is used to secure the top of the child restraint to the vehicle. A top tether anchor is built into the vehicle. The top tether attachment hook (2) on the child restraint connects to the top tether anchor in the vehicle in order to reduce the forward movement and rotation of the child restraint during driving or in the event of a crash.

The child restraint may have a single tether (3) or a dual tether (4). Either will have a single attachment hook (2) to secure the top tether to the anchor.

Some child restraints with a top tether are designed for use with or without the top tether being attached. Others require the

top tether always to be attached. In Canada, the law requires that forward-facing child restraints have a top tether, and that the tether be attached. Be sure to read and follow the instructions for your child restraint.

## Lower Anchor and Top Tether Anchor Locations

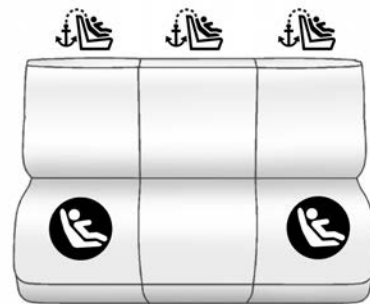

 : Seating positions with top tether anchors.

 : Seating positions with two lower anchors.



To assist in locating the lower anchors, each seating position with lower anchors has two labels near the crease between the seatback and the seat cushion.

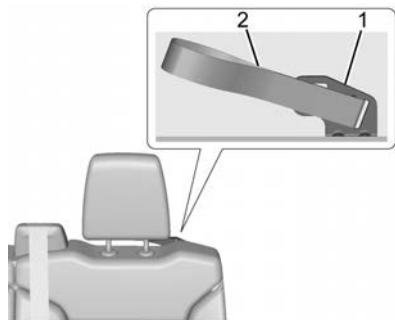

Driver Side Anchor and Loop

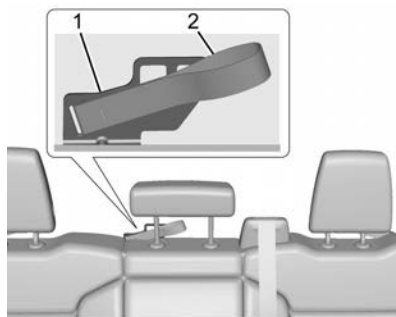

Center Anchor and Loop

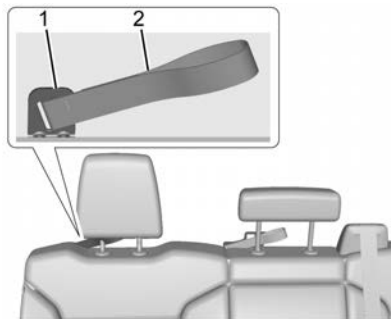

Passenger Side Loop

The top tether is routed through loops (2) to the top tether anchors (1). Be sure to use the correct anchor for the seating position where the child restraint will be placed.

Be sure to read the following instructions to properly install a child restraint using these loops and anchors.

Do not secure a child restraint in a position without a top tether anchor if a national or local law requires that the top tether be attached, or if the instructions that come with the child restraint say that the top tether must be attached.

According to accident statistics, children and infants are safer when properly restrained in a child restraint system or infant restraint system secured in a rear seating position. See *Where to Put the Restraint* ⇨ 67 for additional information.

### Securing a Child Restraint Designed for the LATCH System

#### **Warning**

A child could be seriously injured or killed in a crash if the child restraint is not properly attached to the vehicle using

(Continued)

**Warning (Continued)**

either the LATCH anchors or the vehicle seat belt. Follow the instructions that came with the child restraint and the instructions in this manual.

 **Warning**

Do not attach more than one child restraint to a single anchor, except for the center top tether anchors in the crew cab models. Attaching more than one child restraint to a single anchor could cause the anchor or attachment to come loose or even break during a crash. A child or others could be injured. To reduce the risk of serious or fatal injuries during a crash, attach only one child restraint per anchor.

 **Warning**

Children can be seriously injured or strangled if a shoulder belt is wrapped around their neck. The shoulder belt can tighten but cannot be loosened if it is

(Continued)

**Warning (Continued)**

locked. The shoulder belt locks when it is pulled all the way out of the retractor. It unlocks when the shoulder belt is allowed to go all the way back into the retractor, but it cannot do this if it is wrapped around a child's neck. If the shoulder belt is locked and tightened around a child's neck, the only way to loosen the belt is to cut it.

Buckle any unused seat belts behind the child restraint so children cannot reach them. Pull the shoulder belt all the way out of the retractor to set the lock, and tighten the belt behind the child restraint after the child restraint has been installed.

**Caution**

Do not let the LATCH attachments rub against the vehicle's seat belts. This may damage these parts. If necessary, move buckled seat belts to avoid rubbing the LATCH attachments.

(Continued)

**Caution (Continued)**

Do not fold the rear seat cushion when the seat is occupied. Do not fold the empty rear seat with a seat belt buckled. This could damage the seat belt or the seat. Unbuckle and return the seat belt to its stowed position, before folding the seat.

If you need to secure more than one child restraint in the rear seat, see *Where to Put the Restraint* ⇨ 67.

1. Attach and tighten the lower attachments to the lower anchors. If the child restraint does not have lower attachments or the desired seating position does not have lower anchors, secure the child restraint with the top tether and the seat belt. Refer to the child restraint manufacturer instructions and the instructions in this manual.
- 1.1. Find the lower anchors for the desired seating position.
- 1.2. Put the child restraint on the seat.
- 1.3. Attach and tighten the lower attachments on the child restraint to the lower anchors.

2. For forward-facing child restraints, adjust the top tether to its full length and attach it to the anchor. Follow the child restraint instructions and the vehicle LATCH anchor weight limits described at the beginning of this section, and the following steps:

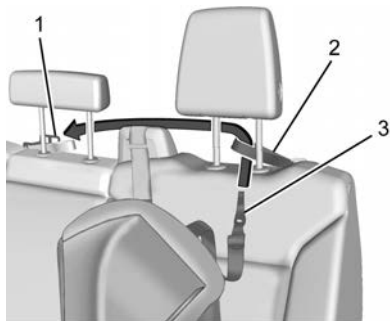

Rear Driver Side Position

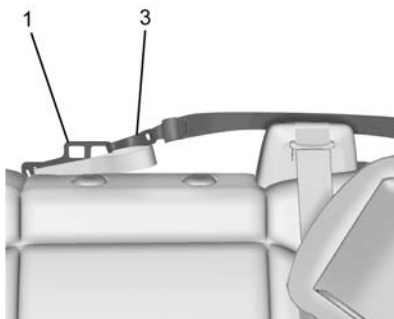

Rear Driver Side Position

- 2.1. For a top tether in the rear driver side position:
- 2.1.1. Remove the driver side head restraint and center headrest. See “Head Restraint or Headrest Removal and Reinstallation” later in this section.

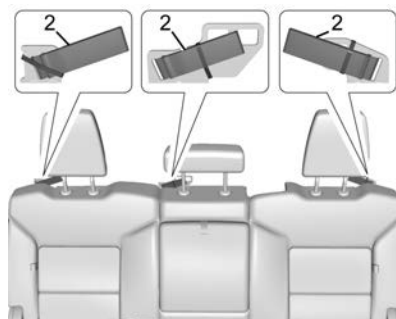

- 2.1.2. For first time use, remove and discard the rubber band from the top tether loop (2).
- 2.1.3. Route the top tether (3) through the loop (2).
- 2.1.4. Attach the top tether (3) to the driver side of the center top tether metal anchor (1).
- 2.1.5. Make sure the child restraint top tether hook is completely closed and secured to the top tether anchor.



Rear Passenger Side Position

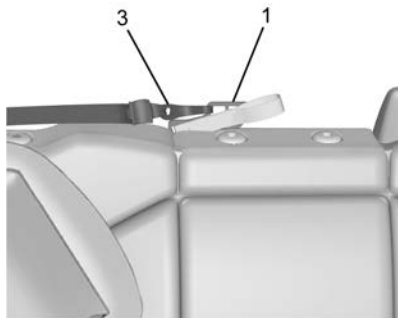

Rear Passenger Side Position

- 2.2. For a top tether in the rear passenger side position:

- 2.2.1. Remove the passenger side head restraint and center headrest. See “Head Restraint or Headrest Removal and Reinstallation” later in this section.
- 2.2.2. Route the top tether (3) through the loop (2).
- 2.2.3. Attach the top tether (3) to the passenger side of the center top tether metal anchor (1).
- 2.2.4. Make sure the child restraint top tether hook is completely closed and secured to the top tether anchor.

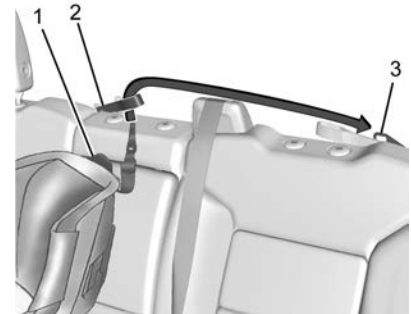

Rear Center Position

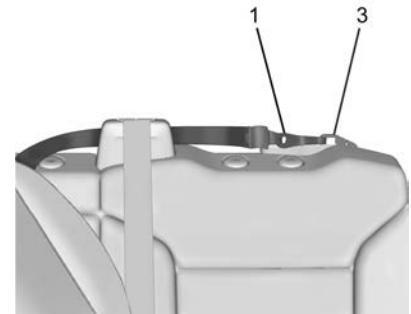

Rear Center Position

- 2.3. For a top tether in the rear center position:



- 2.3.1. Remove the driver side head restraint and center headrest. See "Head Restraint or Headrest Removal and Reinstallation" later in this section.
  - 2.3.2. Route the top tether (1) through the center loop (2).
  - 2.3.3. Attach the top tether (1) to the driver side top tether metal anchor (3).
  - 2.3.4. Make sure the child restraint top tether hook is completely closed and secured to the top tether anchor.
3. Tighten the top tether per the child restraint manufacturer's instructions.

When the top tether is properly tightened, the loop may bend. This is normal and will not damage the vehicle.

If child restraints are installed in both outboard positions, both top tethers can be attached to the center anchor. Top tethers can be attached for child restraints in all three rear seating positions at the same time, following the routing instructions above.

4. Before placing a child in the child restraint, make sure it is securely held in place. To check, grasp the child restraint at the LATCH path and attempt to move it side to side and back and forth. There should be no more than 2.5 cm (1 in) of movement for proper installation.

### Head Restraint or Headrest Removal and Reinstallation

The second row outboard head restraints or center headrest can be removed if they interfere with the proper installation of the child restraint.

To remove the second row head restraints or center headrest:



1. Press both buttons on the head restraint or headrest posts at the same time, and pull up on the head restraint or headrest.
2. Store the head restraint or headrest in a secure place.
3. When the child restraint is removed, reinstall the head restraint or headrest before the seating position is used.

### Warning

With head restraints that are not installed and adjusted properly, there is a greater chance that occupants will suffer a neck/spinal injury in a crash. Do not drive until the head restraints for all occupants are installed and adjusted properly.

To reinstall the head restraint or headrest:



1. Insert the head restraint or headrest posts into the holes in the top of the seatback. The notches on the posts must face the driver side of the vehicle.
2. Push the head restraint or headrest down.
3. Try to move the head restraint or headrest to make sure that it is locked in place.

## Replacing LATCH System Parts After a Crash

### Warning

A crash can damage the LATCH system in the vehicle. A damaged LATCH system may not properly secure the child restraint, resulting in serious injury or even death in a crash. To help make sure the LATCH system is working properly after a crash, see your dealer to have the system inspected and any necessary replacements made as soon as possible.

If the vehicle has the LATCH system and it was being used during a crash, new LATCH system parts may be needed.

New parts and repairs may be necessary even if the LATCH system was not being used at the time of the crash.

## Securing Child Restraints (With the Seat Belt in the Rear Seat)

When securing a child restraint with the seat belts in a rear seat position, study the instructions that came with the child restraint to make sure it is compatible with this vehicle.

If the child restraint has the LATCH system, see *Lower Anchors and Tethers for Children (LATCH System)* ⇨ 69 for how and where to install the child restraint using LATCH. If a child restraint is secured in the vehicle using a seat belt and it uses a top tether, see *Lower Anchors and Tethers for Children (LATCH System)* ⇨ 69 for top tether anchor locations.

Do not secure a child seat in a position without a top tether anchor if a national or local law requires that the top tether be anchored, or if the instructions that come with the child restraint say that the top tether must be anchored.

In Canada, the law requires that forward-facing child restraints have a top tether, and that the tether be attached.

If the child restraint or vehicle seat position does not have the LATCH system, you will be using the seat belt to secure the child restraint. Be sure to follow the instructions that came with the child restraint.

If more than one child restraint needs to be installed in the rear seat, be sure to read *Where to Put the Restraint* ⇨ 67.

1. Put the child restraint on the seat.

2. Pick up the latch plate and run the lap and shoulder portions of the vehicle seat belt through or around the child restraint. Ensure the seat belt webbing is routed as directly as possible and is not caught on seat handles or plastic trim. The child restraint instructions will show you how.



3. Push the latch plate into the buckle until it clicks.

Position the release button on the buckle, away from the child restraint, so that the seat belt could be quickly unbuckled if necessary.

There must not be direct contact of the child restraint to the push button.



4. Pull the shoulder belt all the way out of the retractor to set the lock. When the retractor lock is set, the belt can be tightened but not pulled out of the retractor.

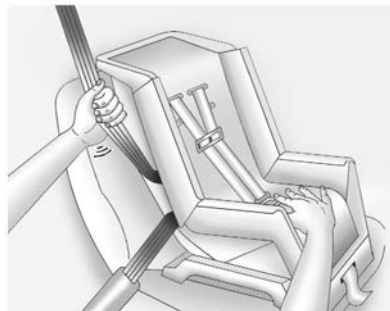

5. To tighten the belt, push down on the child restraint, pull the shoulder portion of the belt to tighten the lap portion of the belt, and feed the shoulder belt back into the retractor. When installing a forward-facing child restraint, it may be helpful to use your knee to push down on the child restraint as you tighten the belt.

Try to pull the belt out of the retractor to make sure the retractor is locked. If the retractor is not locked, repeat Steps 4 and 5.

6. If the child restraint has a top tether, follow the child restraint manufacturer's instructions regarding the use of the top tether. See *Lower Anchors and Tethers for Children (LATCH System)* ⇨ 69.
7. Before placing a child in the child restraint, make sure it is securely held in place. To check, grasp the child restraint at the seat belt path and attempt to move it side to side and back and forth. When the child restraint is properly installed, there should be no more than 2.5 cm (1 in) of movement.

To remove the child restraint, unbuckle the vehicle seat belt and let it return to the stowed position. If the top tether is attached to a top tether anchor, disconnect it.

## Securing Child Restraints (With the Seat Belt in the Front Seat)

This vehicle has airbags. A rear seat is a safer place to secure a forward-facing child restraint. See *Where to Put the Restraint* ⇨ 67.

In addition, the vehicle has a passenger sensing system which is designed to turn off the front outboard passenger frontal airbag

under certain conditions. See *Passenger Sensing System* ⇨ 57 and *Passenger Airbag Status Indicator* ⇨ 101 for more information, including important safety information.

Never put a rear-facing child restraint in the front. This is because the risk to the rear-facing child is so great, if the airbag deploys.

### Warning

A child in a rear-facing child restraint can be seriously injured or killed if the front outboard passenger frontal airbag inflates. This is because the back of the rear-facing child restraint would be very close to the inflating airbag. A child in a forward-facing child restraint can be seriously injured or killed if the front outboard passenger frontal airbag inflates and the passenger seat is in a forward position.

Even if the passenger sensing system has turned off the front outboard passenger frontal airbag, no system is fail-safe. No  
(Continued)

### Warning (Continued)

one can guarantee that an airbag will not deploy under some unusual circumstance, even though it is turned off.

Secure rear-facing child restraints in a rear seat, even if the airbag is off. If you secure a forward-facing child restraint in the front outboard passenger seat, always move the seat as far back as it will go. It is better to secure the child restraint in a rear seat.

See *Passenger Sensing System* ⇨ 57 for additional information.

If the child restraint uses a top tether, see *Lower Anchors and Tethers for Children (LATCH System)* ⇨ 69 for top tether anchor locations.

Do not secure a child seat in a position without a top tether anchor if a national or local law requires that the top tether be anchored, or if the instructions that come with the child restraint say that the top tether must be anchored.

In Canada, the law requires that forward-facing child restraints have a top tether, and that the tether be attached.

When using the lap-shoulder belt to secure the child restraint in this position, follow the instructions that came with the child restraint and the following instructions:

1. Move the seat as far back as it will go before securing the forward-facing child restraint. Move the seat upward or the seatback to an upright position, if needed, to get a tight installation of the child restraint. There must be finger clearance between the push button and the child restraint.

When the passenger sensing system has turned off the front outboard passenger frontal airbag, the OFF indicator on the passenger airbag status indicator should light and stay lit when you start the vehicle. See *Passenger Airbag Status Indicator* ⇨ 101.

2. Put the child restraint on the seat.
3. Pick up the latch plate and run the lap and shoulder portions of the vehicle seat belt through or around the restraint. Ensure the seat belt webbing is routed as direct as possible and is not caught on seat handles or plastic trim. The child restraint instructions will show you how.



4. Push the latch plate into the buckle until it clicks.

Position the release button on the buckle, away from the child restraint, so that the seat belt could be quickly unbuckled if necessary.



5. Pull the shoulder belt all the way out of the retractor to set the lock. When the retractor lock is set, the belt can be tightened but not pulled out of the retractor.

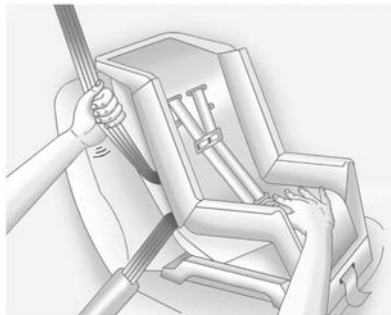

6. To tighten the belt, push down on the child restraint, pull the shoulder portion of the belt to tighten the lap portion of the belt, and feed the shoulder belt back into the retractor.

There must be finger clearance between the push button and the child restraint. If there is not clearance between the buckle push button and the child restraint, move the seat upward and repeat prior installation steps. Otherwise secure the child restraint in a rear seat.

When installing a forward-facing child restraint, it may be helpful to use your knee to push down on the child restraint as you tighten the belt.

Try to pull the belt out of the retractor to make sure the retractor is locked. If the retractor is not locked, repeat Steps 5 and 6.

7. Before placing a child in the child restraint, make sure it is securely held in place. To check, grasp the child restraint at the seat belt path and attempt to move it side to side and back and forth. When the child restraint is properly installed, there should be no more than 2.5 cm (1 in) of movement.

If the airbag is off, the OFF indicator in the passenger airbag status indicator will come on and stay on when the vehicle is started.

If a child restraint has been installed and the ON indicator is lit, see “If the On Indicator Is Lit for a Child Restraint” under *Passenger Sensing System* ⇨ 57.

To remove the child restraint, unbuckle the vehicle seat belt and let it return to the stowed position.

## Storage

### Storage Compartments

Storage Compartments .....	82
Glove Box .....	82
Cupholders .....	82
Underhood Storage (eTrunk™) .....	83
Rear Storage .....	83
Center Console Storage .....	84

### Additional Storage Features

Cargo Tie-Downs .....	84
-----------------------	----

### Roof Rack System

Roof Rack System .....	84
------------------------	----

## Storage Compartments

### ⚠ Warning

Do not store heavy or sharp objects in storage compartments. In a crash, these objects may cause the cover to open and could result in injury.

### Glove Box

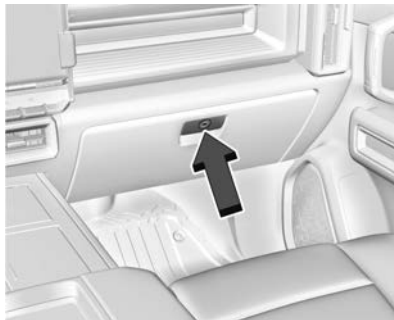

Lift the handle to open the glove box. Close until it latches. Use the mechanical key in the remote key to lock or unlock. See *Keys* ⇨ 6.

## Cupholders

Cupholders in the center console have a retractable cover. Do not place items on the cover.

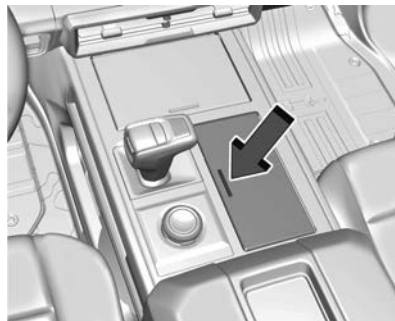

To access the cupholders, press the cover and release.

## Rear Seat Cupholders



If equipped, pull down the rear seat armrest to use the cupholders.

## Underhood Storage (eTrunk™)

There is storage in the front, under the hood. To access the eTrunk™, open the hood. See *Hood* ⇨ 16.

### Caution

**When cleaning the eTrunk™, do not get the exposed electrical components wet. This may damage the vehicle.**

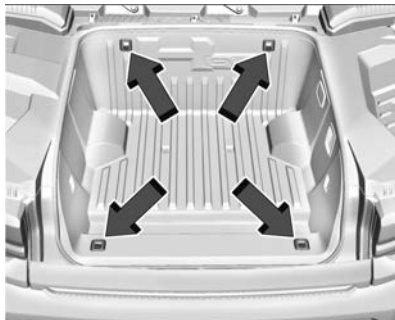

There are four cargo tie-downs in the eTrunk™. These can be used to strap cargo down and keep it from moving inside the vehicle. The maximum load per corner is 50 kg (110 lbs).

To store the roof panels in the eTrunk™, use the Roof Panel Stowage System. See *Roof Panel* ⇨ 31.

## Rear Storage

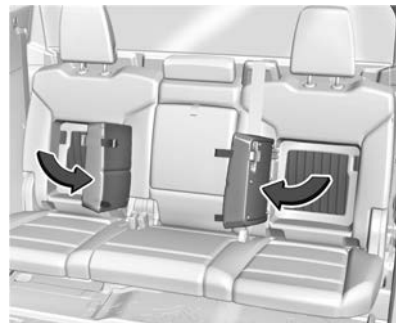

There may be storage in the rear seats. Pull the tab to access.

Push the storage door to close. The storage door must be closed before installing child restraints.



## Center Console Storage



**Bucket Seat**

Press the latch and lift to open.

## Additional Storage Features

### Cargo Tie-Downs

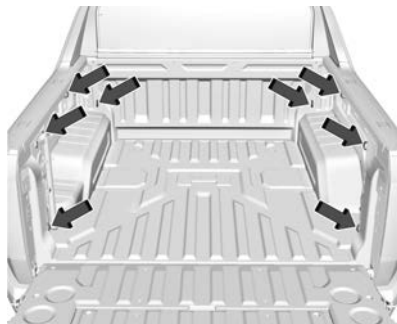

This vehicle is equipped with eight fixed cargo tie-downs.

#### **Caution**

The truck bed walls will collapse if the tie-downs are overloaded.

Any of the eight locations inside the truck bed can be used. The maximum load per corner is 227 kg (500 lb).

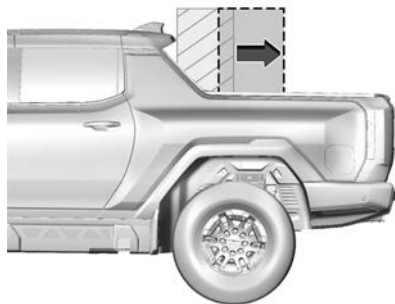

#### **Caution**

Placing tall or oversized items near or against the spoiler or the lamp above the truck bed can result in vehicle damage. To prevent vehicle damage, properly store cargo in the truck bed away from the spoiler and the lamp using the cargo tie-downs.

## Roof Rack System

The vehicle may be equipped with side-rails for a roof rack system. Cargo must be secured with properly installed cross rails

and other accessories designed to carry cargo. These can be purchased from your dealer.

### Warning

Before driving and occasionally during a trip, check that cargo is securely fastened, rests evenly between the cross rails and does not block the vehicle's lamps or windows. Never load cargo directly on the roof of the vehicle or allow cargo to hang over the rear or sides of the vehicle. Never load cargo without first properly installing cross rails and other accessories designed to carry cargo. Personal injury, death or damage to the vehicle or other property may occur.

If driving for a long distance, on rough roads, or at high speeds, occasionally stop the vehicle to make sure the cargo remains in its place.

### Cargo Weight Limits

Do not exceed the maximum cargo weight for the roof rack system, including the weight of the cross rails and any other accessories used to carry the cargo such as bike racks or roof boxes. The maximum

cargo weight that can be loaded onto the roof rack system is 100 kg (220 lb) or the weight designated in the instructions that came with the cross rails or other roof rack accessories, whichever is less.

### Warning

Never load the roof rack with more weight than specified in this section. Loading cargo on the roof rack will make the vehicle's center of gravity higher. To avoid losing control of the vehicle, avoid overloading, high speeds, sudden starts, sharp turns, sudden braking, or abrupt maneuvers when carrying cargo on the roof rack.

The weight of any cargo carried on the roof rack system must be included in calculating the loaded weight of the vehicle. Do not exceed the maximum vehicle capacity when loading the vehicle, including cargo carried on the roof rack system and passengers and cargo carried in the vehicle. For more information on vehicle capacity and loading, see *Vehicle Load Limits* ⇨ 176.

## Instruments and Controls

### Controls

Steering Wheel Adjustment .....	87
Heated Steering Wheel .....	87
Horn .....	87
Pedestrian Safety Signal .....	87
Windshield Wiper/Washer .....	88
Clock .....	89
Power Outlets .....	89
Wireless Charging .....	91

### Warning Lights, Gauges, and Indicators

Warning Lights, Gauges, and Indicators .....	94
Instrument Cluster .....	94
Speedometer .....	97
Odometer .....	97
Trip Odometer .....	97
Battery Gauge (High Voltage) .....	98
Power Indicator Gauge .....	99
Seat Belt Reminders .....	100
Airbag Readiness Light .....	100
Passenger Airbag Status Indicator .....	101
Charging System Light (12-Volt Battery) .....	101
Low State of Charge Light .....	102
Charge Cord Connected Light .....	102
Battery Fault Light .....	102
Propulsion Power is Limited Light .....	102

Service Vehicle Soon Light (Propulsion System Failure) .....	102
Brake System Warning Light .....	102
Electric Parking Brake Light .....	103
Service Electric Parking Brake Light .....	103
Antilock Brake System (ABS) Warning Light .....	103
Four-Wheel-Drive Light .....	104
Lane Keep Assist (LKA) Light .....	104
Automatic Emergency Braking (AEB) Disabled Light .....	104
Vehicle Ahead Indicator .....	105
Pedestrian Ahead Indicator .....	105
Traction Off Light .....	105
StabiliTrak OFF Light .....	105
Traction Control System (TCS)/ StabiliTrak Light .....	106
Driver Mode Control Light .....	106
Four-Wheel Steering Light (CrabWalk Light) .....	106
Air Suspension Light .....	107
Tire Pressure Light .....	107
Security Light .....	108
Vehicle Ready Light .....	108
High-Beam On Light .....	108
Lamps On Reminder .....	108
Cruise Control Light .....	109
Door Ajar Light .....	109

### Information Displays

Charging .....	109
----------------	-----

Energy Information .....	116
Driver Information Center (DIC) .....	116

### Vehicle Messages

Vehicle Messages .....	118
Propulsion Power Messages .....	118
Vehicle Speed Messages .....	119

### Universal Remote System

Universal Remote System .....	119
Universal Remote System Programming .....	119
Universal Remote System Operation ...	121

## Controls

### Steering Wheel Adjustment

#### Power Tilt and Telescoping Steering Wheel



To adjust the steering wheel, if equipped:

1. Press the control up or down to tilt the steering wheel up or down.
2. Press the control rearward or forward to move the steering wheel closer or away from you.

Do not adjust the steering wheel while driving.

### Heated Steering Wheel



 : Press to turn the heated steering wheel on or off. An indicator next to the button is lit when the feature is turned on.

The steering wheel takes about three minutes to start heating.

#### Automatic Heated Steering Wheel

The heated steering wheel may turn on during a remote start along with the heated seats when it is cold outside. The heated steering wheel indicator may come on in remote start.

The heated steering wheel will turn on when the auto heated seat is activated. The heated steering wheel indicator will display the state of the steering wheel heat.

See *Heated and Ventilated Front Seats* ⇨ 43.

To turn this feature on or off, select Settings > Vehicle > Comfort and Convenience > Heated Steering Wheel > Select ON or OFF.

### Horn

To sound the horn, press  on the steering wheel.

### Pedestrian Safety Signal

The vehicle is equipped with automatic sound generation. The automatic sound is generated to indicate the vehicle presence to pedestrians. The sound changes if the vehicle is speeding up or slowing down. It is activated when the vehicle is shifted into a forward gear, N (Neutral), or R (Reverse), up to 34 km/h (21 mph).

## Windshield Wiper/Washer



With the vehicle on, move the windshield wiper lever to select the wiper speed.

**1X** : For a single wipe, briefly move the wiper lever down. For several wipes, hold the wiper lever down.

**OFF** : Use to turn the wipers off.

**AUTO** : If equipped with Rainsense, use this setting for intermittent wipes when Rainsense is disabled, or Rainsense wipes when Rainsense is enabled. For intermittent wipes, move the windshield wiper lever to AUTO, then turn the band up for more frequent wipes or down for less frequent wipes. If Rainsense is turned on, see “Rainsense” later in this section.

**LO** : Use for slow wipes.

**HI** : Use for fast wipes.

 : Pull the windshield wiper lever toward you to spray windshield washer fluid and activate the wipers. The wipers will continue until the lever is released or the maximum wash time is reached. When the windshield wiper lever is released, additional wipes may occur depending on how long the windshield washer has been activated. See *Washer Fluid* ⇨ 297 for information on filling the windshield washer fluid reservoir.

Clear snow and ice from the wiper blades and windshield before using them. If frozen to the windshield, carefully loosen or thaw them. Damaged blades should be replaced. See *Wiper Blade Replacement* ⇨ 302.

### Warning

In freezing weather, do not use the washer until the windshield is warmed. Otherwise the washer fluid can form ice on the windshield, blocking your vision.

### Warning

Before driving the vehicle, always clear snow and ice from the hood, windshield, washer nozzles, roof, and rear of the  
(Continued)

### Warning (Continued)

vehicle, including all lamps and windows. Reduced visibility from snow and ice buildup could lead to a crash.

### Wiper Parking

If the vehicle is turned off while the wipers are on LO, HI, or AUTO with Rainsense turned off, they will immediately stop.

If the windshield wiper lever is then moved to OFF before the driver door is opened or within 10 minutes, the wipers will restart and move to the base of the windshield.

If the vehicle is turned off while the wipers are performing wipes due to windshield washing or Rainsense, the wipers continue to run until they reach the base of the windshield.

### Rainsense

If equipped with Rainsense and the feature is turned on, a sensor near the top center of the windshield detects the amount of water on the windshield and controls the frequency of the windshield wiper based on the current sensitivity setting.

Keep this area of the windshield clear of debris to allow for best system performance.

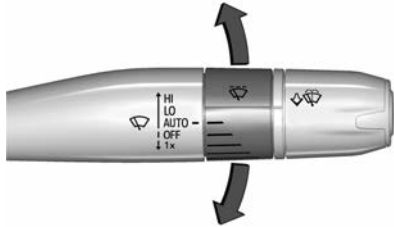

**AUTO** : Move the windshield wiper lever to AUTO. Turn the band on the wiper lever to adjust the sensitivity.

- Turn the band up for more sensitivity to moisture.
- Turn the band down for less sensitivity to moisture.
- Move the windshield wiper lever out of the AUTO position to deactivate Rainsense.

To turn this feature on or off, select Settings > Vehicle > Comfort and Convenience > Rainsense Wipers > Select ON or OFF.

### Wiper Arm Assembly Protection

When using an automatic car wash, move the windshield wiper lever to OFF. This disables the automatic Rainsense windshield wipers.

With Rainsense, if the vehicle is in N (Neutral) and the vehicle speed is very slow, the wipers will automatically stop at the base of the windshield.

The wiper operation returns to normal when the vehicle is no longer in N (Neutral) or the vehicle speed has increased.

### Clock

Set the time and date using the infotainment system. See "Time/Date" under Settings ⇨ 148.

### Power Outlets

#### Power Outlets 12-Volt Direct Current

The vehicle has two 12-volt outlets that can be used to plug in electrical equipment, such as a tablet or MP3 player.

Lift the cover to access the outlet and replace when not in use.

The power outlets are located:

- In the center console storage area under the armrest
- In the eTrunk™ area

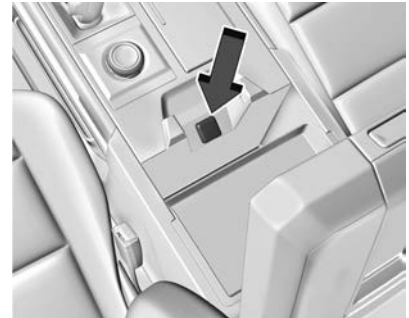

**Center Console 12 Volt Power Outlet**

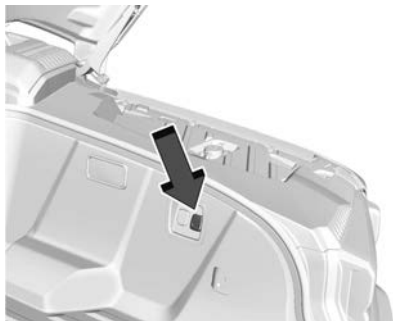

eTrunk™ 12 Volt Power Outlet

**Caution**

Leaving electrical equipment plugged in for an extended period of time while the vehicle is off will drain the battery. Always unplug electrical equipment when not in use and do not plug in equipment that exceeds the maximum 15 amp rating.

Certain accessory plugs may not be compatible with the accessory power outlet and could overload vehicle and adapter fuses. If a problem is experienced, see your dealer.

When adding electrical equipment, be sure to follow the proper installation instructions included with the equipment. See *Add-On Electrical Equipment* ⇨ 288.

**Caution**

Hanging heavy equipment from the power outlet can cause damage not covered by the vehicle warranty. The power outlets are designed for accessory power plugs only, such as cell phone charge cords.

**Power Outlet 110/120 Volt Alternating Current**

The vehicle has two 110/120 Volt Alternating Current outlets.

Lift the cover to access and replace when not in use.

The power outlets are located:

- On the rear of the center console
- In the truck bed

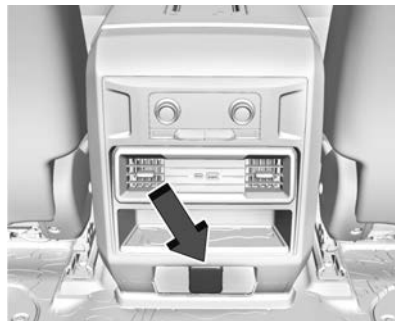

Center Console 110/120 Volt Power Outlet



Truck Bed 110/120 Volt Power Outlet

When the power button is ON/RUN, power to the 110 Volt outlet is enabled after the  button is pressed, see *Instrument Panel Overview* ⇨ 4 for button location.

A green indicator light on the button indicates when the 110 Volt outlet is enabled. 110 Volt power is supplied to the outlet when it is enabled and electrical equipment is plugged into that outlet. One power outlet can be used with electrical equipment that uses a maximum of 400 watts. Ensure that all connected devices do not exceed 400 watts.

The power outlet can be turned off by pressing the  button.

An indicator light on the outlet illuminates when the system is enabled and no system fault is detected. The outlet will not provide power when the vehicle is off, the  button is not pressed, or the plug is not fully seated into the outlet. The outlet does not operate while the vehicle is starting. If a USB powered streaming device is being used, it is suggested to use a USB Port for power, see *USB Port* ⇨ 136. If uninterrupted power supply is required while driving, disable the auto-stop feature, see *Retained Accessory Power (RAP)* ⇨ 182.

If equipment is connected using more than 400 watts or a system fault is detected, a protection circuit shuts off the power supply and the indicator light will flash.

Do not use a power outlet with a missing or damaged cover.

The power outlet is not designed for the following, and may not work properly if they are plugged in:

- Equipment with high initial peak wattage, such as compressor-driven refrigerators and electric power tools
- Other equipment requiring an extremely stable power supply, such as microcomputer-controlled electric blankets and touch sensor lamps
- Medical equipment

## Wireless Charging

If equipped and enabled, the vehicle has wireless charging in the bin below the climate control system. The system operates at 145 kHz and wirelessly charges one Qi compatible smartphone. The power output of the system is capable of charging at a rate up to 3 amp (15 W), as requested by the compatible smartphone. See *Radio Frequency Statement* ⇨ 374.

## Warning

Wireless charging may affect the operation of an implanted pacemaker or other medical devices. If you have one, it is recommended to consult with your doctor before using the wireless charging system.

The vehicle must be on or Retained Accessory Power (RAP) must be active. The wireless charging feature may not correctly indicate charging when the vehicle is in RAP, during a Bluetooth phone call, or when phone projection (e.g. Apple CarPlay/Android Auto) is active. See *Retained Accessory Power (RAP)* ⇨ 182.

The operating temperature is -40 °C (-40 °F) to 85 °C (185 °F) for the charging system and 0 °C (32 °F) to 35 °C (95 °F) for the phone. A charging stopped alert may be displayed on the infotainment screen, if the wireless charger or smartphone are outside of normal operating temperature. Charging will automatically resume when a normal operating temperature is reached.



**⚠ Warning**

Remove all objects from the charger before charging your compatible smartphone. Objects, such as coins, keys, rings, paper clips, or cards, between the smartphone and charger may become very hot.

On the rare occasion that the charging system does not detect an object, and the object gets wedged between the smartphone and charger, remove the smartphone and allow the object to cool before removing it from the charger, to prevent burns.

To charge a compatible smartphone:

1. Confirm the smartphone is capable of wireless charging.

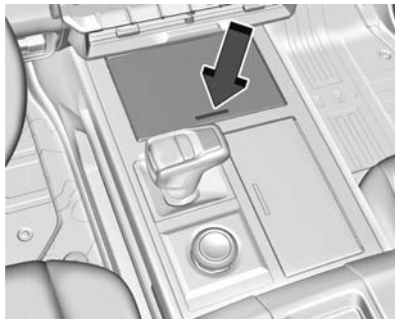

2. The wireless charger is in the bin below the climate control system. If the cover is closed, press the cover to access the wireless charging pad. Do not place items on the cover.

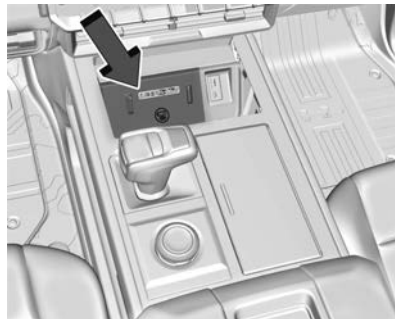

3. Remove all objects from the charging pad. The system may not charge if there are any objects between the smartphone and charger.
4. Place the smartphone face up against the rubber charge mat in between the two small vertical rubber ribs.

To maximize the charge rate, ensure the smartphone is fully seated and centered in the holder with nothing under it.

A thick smartphone case may prevent the charger from working, or reduce the charging performance. See your dealer for additional information.

5. A green ⚡ will appear on the infotainment display, next to the phone icon. This indicates that the smartphone is on the charger. The green ⚡ will remain on while the phone is charging.
6. If a smartphone is placed on the charger and ⚡ turns off or a yellow triangle appears, remove the smartphone and any objects from the pad. Turn the smartphone 180 degrees and wait a few seconds before placing/aligning it on the pad again. If the status stays yellow, phone may not be a compatible phone. The status will turn yellow when any object other than a phone is placed on this charger mat.
7. If a smartphone is placed on the charger and a red circle appears, the charger and/or the smartphone is overheated. Remove the smartphone and any objects from the charger in order to cool the system.

The smartphone may become warm during charging. This is normal. In warmer temperatures, the speed of charging may be reduced.

For vehicles with wireless phone projection, the smartphone may overheat during wireless charging. The smartphone may slow down, stop charging, or shut down to protect the battery. The phone may need to be removed from its case to prevent overheating. The ⚡ may flash while the phone is cooling down enough for wireless charging to automatically resume. This is normal. Individual phone performance may vary.

#### Software Acknowledgments

Certain Wireless Charging Module product from LG Electronics, Inc. ("LGE") contains the open source software detailed below. Refer to the indicated open source licenses (as are included following this notice) for the terms and conditions of their use.

#### OSS Notice Information

To obtain the source code that is contained in this product, please visit <https://opensource.lge.com>. In addition to the source code, all referred license terms, warranty disclaimers and copyright notices are available for download. LG Electronics will also provide open source code to you on CD-ROM for a charge covering the cost of performing such distribution (such as the

cost of media, shipping, and handling) upon email request to [opensource@lge.com](mailto:opensource@lge.com). This offer is valid for three (3) years from the date on which you purchased the product.

#### Freescalce-WCT library

Copyright (c) 2012-2014 Freescalce Semiconductor, Inc.. All rights reserved.

Redistribution and use in source and binary forms, with or without modification, are permitted provided that the following conditions are met:

1. Redistributions of source code must retain the above copyright notice, this list of conditions and the following disclaimer.
2. Redistributions in binary form must reproduce the above copyright notice, this list of conditions and the following disclaimer in the documentation and/or other materials provided with the distribution.
3. Neither the name of the copyright holder nor the names of its contributors may be used to endorse or promote products derived from this software without specific prior written permission.

THIS SOFTWARE IS PROVIDED BY THE COPYRIGHT HOLDERS AND CONTRIBUTORS "AS IS" AND ANY EXPRESS OR IMPLIED WARRANTIES, INCLUDING, BUT NOT LIMITED TO, THE IMPLIED WARRANTIES OF MERCHANTABILITY AND FITNESS FOR A PARTICULAR PURPOSE ARE DISCLAIMED. IN NO EVENT SHALL THE COPYRIGHT HOLDER OR CONTRIBUTORS BE LIABLE FOR ANY DIRECT, INDIRECT, INCIDENTAL, SPECIAL, EXEMPLARY, OR CONSEQUENTIAL DAMAGES (INCLUDING, BUT NOT LIMITED TO, PROCUREMENT OF SUBSTITUTE GOODS OR SERVICES; LOSS OF USE, DATA, OR PROFITS; OR BUSINESS INTERRUPTION) HOWEVER CAUSED AND ON ANY THEORY OF LIABILITY, WHETHER IN CONTRACT, STRICT LIABILITY, OR TORT (INCLUDING NEGLIGENCE OR OTHERWISE) ARISING IN ANY WAY OUT OF THE USE OF THIS SOFTWARE, EVEN IF ADVISED OF THE POSSIBILITY OF SUCH DAMAGE.

## Warning Lights, Gauges, and Indicators

Warning lights and gauges can signal that something is wrong before it becomes serious enough to cause an expensive repair or replacement. Paying attention to the warning lights and gauges could prevent injury.

Some warning lights come on briefly when the propulsion system is started to indicate they are working. When one of the warning lights comes on and stays on while driving, or when one of the gauges shows there may be a problem, check the section that explains what to do. Waiting to do repairs can be costly and even dangerous.

## Instrument Cluster

The instrument cluster displays a preview of information including electric range, charging, odometer, and battery status when the driver door is opened, before starting the vehicle. This preview dismisses after starting the vehicle or soon after closing the driver door.

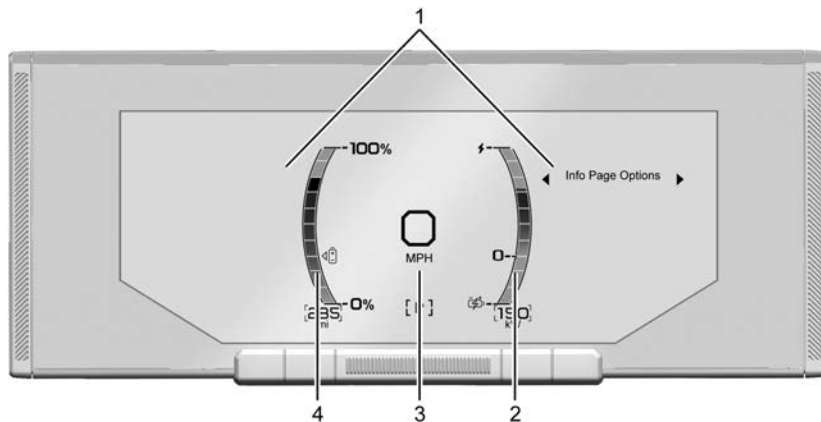

English Cluster Lunar Display Shown, Others and Metric Similar

1. *Driver Information Center (DIC)* ⇨ 116
2. *Power Indicator Gauge* ⇨ 99
3. *Speedometer* ⇨ 97
4. *Battery Gauge (High Voltage)* ⇨ 98

### Reconfigurable Instrument Cluster

The instrument cluster layout can be changed. There are five display configurations to choose from: Lunar, Clean, Sport, Off-Road, and Digital. Use the steering

wheel control to move between the different display zones and scroll through the different displays. See “Display Layout” under “Options.”

- Lunar configuration displays the speedometer, battery gauge, and power indicator gauge in the center of the display. There are two DIC areas on the left and right of the display.

- Clean configuration is a simplified display that has the speedometer on the top center. The battery gauge is located below the speedometer. There is one DIC area to the far right of the display.
- Sport configuration displays the speedometer in the center of the display. The battery gauge is located below the speedometer and the power indicator gauge is above it. There are two DIC areas on the left and right of the display.
- Off-Road configuration displays the speedometer in the top center. The battery gauge is located on the bottom left side of the display and the power indicator gauge is on the bottom right side. There are three DIC areas in the left, right, and center of the display.
- Digital configuration displays the speedometer in the center of the display. The battery gauge is located on the far left of the display and the power indicator gauge is on the far right. There are two DIC areas to the left and right of the speedometer.

### Acceleration Mode (Watts to Freedom)

While in Acceleration Mode, the speedometer will appear in the center of the display with the battery gauge below it and

the torque gauge above it. There are two DIC areas on the left and right of the display.

Follow the prompts on the instrument cluster. See *Acceleration Mode (Watts to Freedom)* ⇨ 193.

### Launch Status

**Lowering** : Vehicle ride height is lowering to optimize weight transfer. Keep doors closed and watch your surroundings.

**Standby** : Watts to Freedom is prepared for the vehicle to come to a stop.

**Cooling** : Battery system is cooling for maximum torque delivery.

**Warming** : Battery system is warming up for maximum torque delivery.

**Ready** : The system is prepared for launch. Press the brake with your left foot and follow the instructions shown in the instrument cluster.

### Cluster Menu

There are interactive display areas in the instrument cluster. Locations vary by the selected display layout.

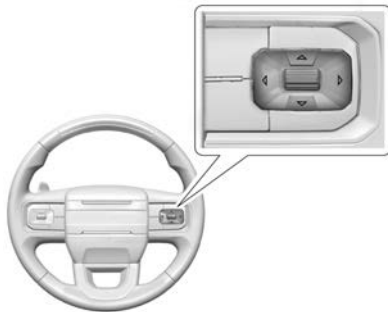

Use the right steering wheel control to open and scroll through the different items and displays.

Press ◀ or ▶ to access the cluster applications. Move ▲ or ▼ to scroll through the list of available applications. Press the ▲ / ▼ switch to select. Not all applications or features are available on all vehicles.

- Vehicle info. This is where the Driver Information Center (DIC) displays can be viewed. See *Driver Information Center (DIC)* ⇨ 116.
- Audio
- Navigation
- Phone

- Options

### Left/Right Side Info

Information displayed here can be customized from the Options menu. See “Options” below.

**Compass** : If equipped, shows the direction the vehicle is heading.

**Time & Outside Temperature** : Displays the current time and outside air temperature.

**Tire Pressure** : Shows the approximate pressures of all four tires. Tire pressure is displayed in either kilopascal (kPa) or in pounds per square inch (psi). If the pressure is low, the value for that tire is shown in amber.

**Pitch/Roll** : Displays vehicle pitch and roll information.

**G-force** : Indicates the acceleration, braking, and cornering performance of the vehicle. The G-force is displayed as a numerical value and as graphical depiction.

**None** : Displays the info area as empty.

**Audio**

Browse music, select from the favorites, or change the audio source. Move  $\triangle$  or  $\nabla$  to change the station or go to the next or previous track.

**Navigation**

If there is an active route, the Turn-by-Turn directions will appear on the Navigation Page, if there is no active route a compass will be displayed.

**Phone**

If there is no active phone call, view recent calls, or scroll through contacts.

**Options**

Move  $\triangle$  or  $\nabla$  to scroll through items in the Options menu.

**Display Layout** : Choose Lunar, Clean, Sport, Off-Road, and Digital layout by pressing the  $\triangle$  /  $\nabla$  switch while the desired item is highlighted. Exit the Layout menu by pressing  $\triangleleft$ .

**Left/Right Side Info** : Press the  $\triangle$  /  $\nabla$  switch to select the items to be displayed in the display areas. See "Left/Right Side Info" previously in this section.

**Info Page Options** : Press the  $\triangle$  /  $\nabla$  switch to select the items to be displayed in the Info app. See *Driver Information Center (DIC)*  $\Rightarrow$  116.

**Units** : Choose US or metric units by pressing the  $\triangle$  /  $\nabla$  switch while the desired item is highlighted.

**Speed Warning** : Press the  $\triangle$  /  $\nabla$  switch when Speed Warning is displayed to set the Speed Warning. Move  $\triangle$  or  $\nabla$  to adjust the value and press the  $\triangle$  /  $\nabla$  switch to set the speed.

The Speed Warning display allows the driver to set a speed that they do not want to exceed. Once the speed is set, this feature can be turned off by pressing while viewing this page. If the selected speed limit is exceeded, a pop-up warning is displayed with a chime.

**Speed Sign Display** : Press the  $\triangle$  /  $\nabla$  switch while the desired item is highlighted to turn on or off. Shows sign information, which comes from a roadway database in the onboard navigation system, if equipped. The sign will show “-” when offline maps are unavailable. See *Maps*  $\Rightarrow$  138.

**Software Information** : Displays open source software information.

**Reset To Defaults** : Allows the driver to reset to default settings.

**Speedometer**

The speedometer shows the vehicle speed in either kilometers per hour (km/h) or miles per hour (mph).

**Odometer**

The odometer shows how far the vehicle has been driven, in either kilometers or miles.

**Trip Odometer**

The trip odometer shows how far the vehicle has been driven since the trip odometer was last reset.

The trip odometer is accessed and reset through the Driver Information Center (DIC). See *Driver Information Center (DIC)*  $\Rightarrow$  116.

## Battery Gauge (High Voltage)

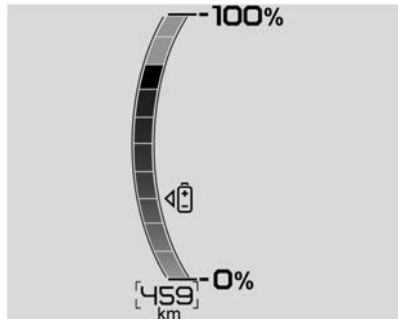

**Metric Lunar Battery Gauge Shown, Others Similar**

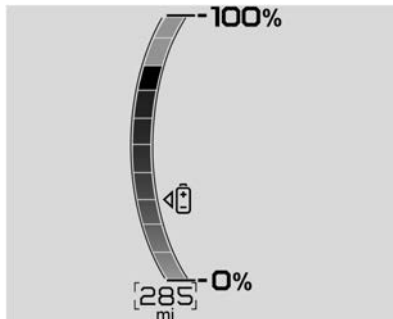

**English Lunar Battery Gauge Shown, Others Similar**

This displays the high voltage battery state of charge. The value at the bottom is an estimate of how far the vehicle can be driven on the remaining charge based on recent driving habits, conditions, and HVAC usage.

The fill bars shown inside of the gauge indicate the percentage range as estimated from current vehicle conditions and climate settings. The range estimate on the bottom also may be affected by climate settings, current vehicle conditions and ambient conditions. Estimated range may increase and decrease based on climate control energy consumption.

Driving at sustained high speeds, driving aggressively through hard acceleration and/or braking events, excessive HVAC usage, using heated or cooled seats, battery preconditioning, and performance modes can affect vehicle range estimates.

When the high voltage battery state of charge level gets low, the gauge will change color to amber. When the charge is very low the gauge will flash, and the estimated range value on the bottom will change to LOW. Additional alerts may display and a sound may also be heard at low state of charge.

## Power Indicator Gauge

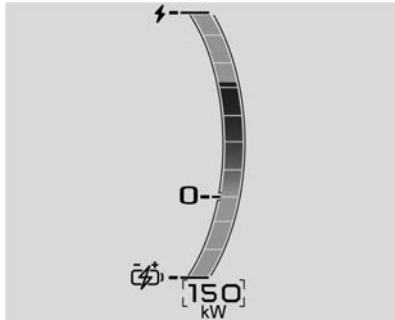

Lunar Power Indicator Gauge Shown, Others Similar

The power indicator gauge is in the center of the display to the right of the speedometer in the Lunar layout.

This gauge displays the instantaneous charge and consumption power of the high voltage battery. Maximum power consumption is available when the high voltage battery is fully charged. During normal operation, a slight reduction in consumption power may occur as the high voltage battery state of charge decreases.

## Regenerative Braking

When regenerative braking is active, the regen battery icon appears green and will show a green tail on the fill bar. The power indicator gauge value shows the amount of instantaneous power being regenerated.

## Regenerative Power Limited

Regenerative power may be limited when the high voltage battery is near full charge or cold. This will affect the vehicle's maximum regenerative braking power.

## Watts To Freedom

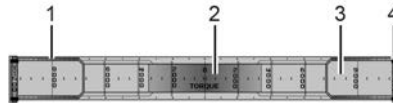

## Acceleration Mode Torque Gauge Shown

1. Progress Bar
2. Active Torque
3. Freedom Zone
4. Peak Hold Bar

The power indicator gauge is replaced with the torque gauge while in Acceleration Mode. It is located centered on the top of

the display. Follow the prompts on the instrument cluster. See *Acceleration Mode (Watts to Freedom)* ⇨ 193.

**Preparing** : While the vehicle is preparing the progress bars fill and appear blue.

**Complete** : As the vehicle has completed preparation the progress bars show full with a white line separating the active torque fill from the freedom zones.

**Ready** : When the vehicle is stopped and ready the white line disappears, and the progress bars remain blue until the active torque crosses into freedom zones.

**Launch** : As the vehicle launches the active torque moves into the freedom zones and the progress bars become orange. The peak hold bars appear at the leading edge of the active torque.

**Torque Ramp Down** : When the torque is ramping down the peak bars are held where the active torque peaked.

**Freedom Zones Vacated** : While the freedom zones are vacated nothing further happens until the launch run is exited and the throttle is lifted.



**Throttle Lifted** : As the throttle is lifted the white lines close off the freedom zones. The active torque decreases and the orange bars turn back to blue to reflect the current preparation state.

**Peak Bars Removed** : Finally, the peak hold bars are removed after the vehicle exits launch run.

## Seat Belt Reminders

### Driver Seat Belt Reminder Light

There is a driver seat belt reminder light on the instrument cluster.



When the vehicle is started, this light flashes and a chime may come on to remind the driver to fasten their seat belt.

Then the light stays on solid until the belt is buckled. This cycle may continue several times if the driver remains or becomes unbuckled while the vehicle is moving.

If the driver seat belt is buckled, neither the light nor the chime comes on.

### Front Passenger Seat Belt Reminder Light

The vehicle may have a front passenger seat belt reminder light near the passenger airbag status indicator. See *Passenger Sensing System* ⇨ 57.



When the vehicle is started, this light flashes and a chime may come on to remind passengers to fasten their seat belt.

Then the light stays on solid until the belt is buckled. This cycle continues several times if the front passenger remains or becomes unbuckled while the vehicle is moving.

If the front passenger seat belt is buckled, neither the chime nor the light comes on.

The front passenger seat belt reminder light and chime may come on if an object is put on the seat such as a briefcase, handbag, grocery bag, laptop, or other electronic

device. To turn off the reminder light and/or chime, remove the object from the seat or buckle the seat belt.

### Airbag Readiness Light

This light shows if there is an electrical problem with the airbag system. It is located in the instrument cluster. The system check includes the airbag sensor(s), the passenger sensing system, the pretensioners, the airbag modules, the wiring, and the crash sensing and diagnostic module. For more information on the airbag system, see *Airbag System* ⇨ 53.



The airbag readiness light comes on for several seconds when the vehicle is started. If the light does not come on then, have it fixed immediately.

**⚠ Warning**

If the airbag readiness light stays on after the vehicle is started or comes on while driving, it means the airbag system might not be working properly. The airbags in the vehicle might not inflate in a crash, or they could even inflate without a crash. To help avoid injury, have the vehicle serviced right away.

If there is a problem with the airbag system, a Driver Information Center (DIC) message may also come on.

**Passenger Airbag Status Indicator**

The vehicle has a passenger sensing system. See *Passenger Sensing System* ⇨ 57 for important safety information. The overhead console has a passenger airbag status indicator.

**PASSENGER AIR BAG****ON****OFF**

United States

**Canada**

When the vehicle is started, the passenger airbag status indicator will light ON and OFF, or the symbols for on and off, for several seconds as a system check. Then, after several more seconds, the status indicator will light either ON or OFF, or either the on or off symbol, to let you know the status of the front outboard passenger frontal airbag.

If the word ON, or the on symbol, is lit on the passenger airbag status indicator, it means that the front outboard passenger frontal airbag is allowed to inflate.

If the word OFF, or the off symbol, is lit on the passenger airbag status indicator, it means that the passenger sensing system has turned off the front outboard passenger frontal airbag.

If, after several seconds, both status indicator lights remain on, if there are no lights at all, or if the airbag readiness light

is on, there may be a problem with the lights or the passenger sensing system. See your dealer for service right away.

**⚠ Warning**

If the airbag readiness light ever comes on and stays on, it means that something may be wrong with the airbag system. To help avoid injury to yourself or others, have the vehicle serviced right away. See *Airbag Readiness Light* ⇨ 100 for more information, including important safety information.

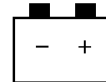
**Charging System Light (12-Volt Battery)**

The charging system light comes on briefly when the vehicle is started, as a check to show the light is working.

If the light stays on, or comes on while driving, there could be a problem with the electrical charging system. Have it checked by your dealer. Driving while this light is on could drain the 12-volt battery.

If a short distance must be driven with the light on, be sure to turn off all accessories, such as the radio. Find a safe place to stop the vehicle.

### Low State of Charge Light



This light comes on when the vehicle state of charge is low. Proceed to a charging station to charge the vehicle.

### Charge Cord Connected Light



If equipped, this light comes on when a charge cord is connected to the vehicle.

### Battery Fault Light



This light indicates a fault with the high voltage battery. A message may also display in the Driver Information Center (DIC). See your dealer for service.

### Propulsion Power is Limited Light

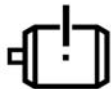

If equipped, these lights display when the vehicle propulsion power is limited, which may affect the vehicle's ability to accelerate. The vehicle may be driven while these lights are on, but maximum acceleration and speed may be limited.

### Service Vehicle Soon Light (Propulsion System Failure)



This light comes on if a condition exists that may require the vehicle to be taken in for service.

If the light comes on, take the vehicle to your dealer for service as soon as possible.

### Brake System Warning Light



BRAKE

Metric

English

This light comes on briefly when the vehicle is turned on to show that the light is working. If it does not come on then, have it fixed so it will be ready to warn you if there is a problem.

If the light comes on and stays on, there is a brake problem. Have the brake system inspected right away. This light may come on if the brake fluid is low. See *Brake Fluid* ⇨ 298.

If the light comes on while driving, pull off the road and stop carefully. The brake pedal might be harder to push, or the brake pedal may go closer to the floor. It could take longer to stop. If the light is still on, have the vehicle towed for service. See *Transporting a Disabled Vehicle* ⇨ 347.

### Warning

The brake system might not be working properly if the brake system warning light is on. Driving with the brake system warning light on can lead to a crash. If the light is still on after the vehicle has been pulled off the road and carefully stopped, have the vehicle towed for service.

## Electric Parking Brake Light



Metric

PARK

English

This light comes on when the parking brake is applied. If the light continues flashing after the parking brake is released, or while driving, there is a problem with the Electric Parking Brake system. A message may also display in the Driver Information Center (DIC).

If the light does not come on, or remains flashing, see your dealer.

## Service Electric Parking Brake Light



This light should come on briefly when the vehicle is turned on. If it does not come on, have it fixed so it will be ready to warn if there is a problem.

If this light stays on or comes on while driving, there is a problem with the Electric Parking Brake (EPB). Take the vehicle to a dealer as soon as possible. In addition to the parking brake, other safety functions that utilize the EPB may also be degraded. A message may also display in the Driver Information Center (DIC). See *Electric Parking Brake* ⇨ 189.

## Antilock Brake System (ABS) Warning Light



This light comes on briefly when the vehicle is turned on to show that the light is working. If it does not come on then, have it fixed so it will be ready to warn you if there is a problem.

Engagement of the 4WD front axle lock will disable ABS and illuminate the ABS warning light. The ABS warning light will turn off when the front axle lock is disengaged.

If the ABS warning light stays on, or comes on again while driving, the vehicle needs service. A chime may also sound when the light stays on.

If the ABS warning light is the only light on, the vehicle has regular brakes, but ABS is not functioning.

If both the ABS warning light and the brake system warning light are on, ABS is not functioning and there is a problem with the regular brakes. See your dealer for service.

See *Brake System Warning Light* ⇨ 102.

## Four-Wheel-Drive Light

eAWD

This light is amber when the electric four-wheel drive (e4WD) system is limited, and will turn off when the system is working normally.

If this light is red, there may be a malfunction. See your dealer.

See *Four-Wheel Drive* ⇨ 188.

## Lane Keep Assist (LKA) Light



If equipped, the Lane Keep Assist Light may display the following colors:

- Blank: LKA is disabled.
- White: Appears when the vehicle starts. A steady white light indicates that LKA is not ready to assist.
- Green: Appears when LKA is turned on and ready to assist. LKA will gently turn the steering wheel if the vehicle approaches a detected lane marking.
- Amber: Appears when LKA is active. The light flashes amber as a Lane Departure Warning (LDW) alert to indicate that the lane marking has been unintentionally crossed. If the system detects you are steering intentionally (to pass or change lanes), the LDW alert may not display.

LKA will not assist or alert if the turn signal is active in the direction of lane departure, or if LKA detects that you are accelerating, braking, or actively steering. See *Lane Keep Assist (LKA)* ⇨ 250.

## Automatic Emergency Braking (AEB) Disabled Light



This indicator displays when you turn off Automatic Emergency Braking (AEB) or Front Pedestrian Braking (FPB).

This indicator will also display if AEB or FPB is unavailable due to malfunction, weather conditions, or if the windshield is not clean.

See *Automatic Emergency Braking (AEB)* ⇨ 245.

See *Front Pedestrian Braking (FPB) System* ⇨ 246.

## Vehicle Ahead Indicator



If equipped, this indicator will display green when a vehicle is detected ahead and amber when you are following a vehicle ahead much too closely.

See *Forward Collision Alert (FCA) System* ⇨ 243.

## Pedestrian Ahead Indicator



If equipped, this indicator will display amber when a nearby pedestrian is detected in front of the vehicle.

See *Front Pedestrian Braking (FPB) System* ⇨ 246.

## Traction Off Light



This light comes on briefly when the vehicle is turned on to show that the light is working. If it does not come on then, have it fixed so it will be ready to warn you if there is a problem.

The traction off light comes on when the Traction Control System (TCS) has been turned off. If StabiliTrak/Electronic Stability Control (ESC) is turned off, TCS is also turned off. To turn TCS and ESC off and on, see *Traction Control/Electronic Stability Control* ⇨ 191.

If TCS is off, wheel slip during acceleration is not limited unless necessary to help protect the driveline from damage. Adjust driving accordingly.

## StabiliTrak OFF Light



This light comes on briefly when the vehicle is turned on to show that the light is working. If it does not come on then, have it fixed so it will be ready to warn you if there is a problem.

This light comes on when the StabiliTrak/Electronic Stability Control (ESC) system is turned off. If StabiliTrak/ESC is off, the Traction Control System (TCS) is also off. To turn ESC off and on, see *Traction Control/Electronic Stability Control* ⇨ 191.

If ESC and TCS are off, the systems do not assist in controlling the vehicle. Adjust driving accordingly.

## Traction Control System (TCS)/ StabiliTrak Light



This light comes on briefly when the vehicle is turned on to show that the light is working. If it does not come on then, have it fixed so it will be ready to warn you if there is a problem.

If the light is on and not flashing, the TCS and potentially the StabiliTrak/ESC system are not fully operational and may not assist in maintaining control. Adjust driving accordingly. If the condition persists, see your dealer as soon as possible. A Driver Information Center (DIC) message may display.

The light flashes when the TCS and/or the StabiliTrak/ESC system is actively working.

See *Traction Control/Electronic Stability Control* ⇨ 191.

## Trailer Sway Control Light



This light will flash when Trailer Sway Control is active. See *Trailer Sway Control (TSC)* ⇨ 278.

## Driver Mode Control Light



This light comes on when the Tow/Haul Mode is selected.



This light comes on when Off-Road Mode is selected.



This light comes on when Terrain Mode is selected.



This light comes on when My Mode is selected. See *Driver Mode Control* ⇨ 194.

## Four-Wheel Steering Light (CrabWalk Light)



This light is amber when Rear Wheel Steering is off.



This light is amber when CrabWalk Mode is active.

### Air Suspension Light



This light comes on when the air suspension is raised to Extract Mode.



This light comes on when the air suspension is raised to increased ground clearance height.

It will flash white and give an alert to indicate that the vehicle is changing to a higher ride height.



This light comes on when the air suspension is lowered for easy entry and exit from the vehicle, or when Acceleration Mode (Watts to Freedom) is activated.

It will flash white and give an alert to indicate that the vehicle is changing to a lower ride height.



This light comes on when the air suspension is in Service Mode or Alignment Mode.

See *Air Suspension* ⇨ 207.

### Tire Pressure Light



If equipped with the Tire Pressure Monitor System (TPMS), this light comes on briefly when the vehicle is started. It provides information about tire pressures and the TPMS.

#### When the Light Is On Steady

This indicates that one or more of the tires are significantly underinflated.

A Driver Information Center (DIC) tire pressure message may also display. Stop as soon as possible, and inflate the tires to the pressure value shown on the Tire and Loading Information label. See *Tire Pressure* ⇨ 319.



**When the Light Flashes First and Then Is On Steady**

If the light flashes for about a minute and then stays on, there may be a problem with the TPMS. If the problem is not corrected, the light will come on every time the vehicle is started. See *Tire Pressure Monitor Operation* ⇨ 321.

**Security Light**



The security light should come on briefly as the vehicle is started. If it does not come on, have the vehicle serviced by your dealer. If the system is working normally, the indicator light turns off.

If the light stays on and the vehicle does not start, there could be a problem with the theft-deterrent system. See *Immobilizer Operation* ⇨ 24.

**Vehicle Ready Light**



The vehicle ready light comes on whenever the vehicle is parked and ready to be driven.

**High-Beam On Light**



This light comes on when the high-beam headlamps are in use. See *Headlamp High/Low-Beam Changer* ⇨ 123.

**IntelliBeam Light**



If equipped, this light comes on when the IntelliBeam system is enabled. See *Exterior Lamp Controls* ⇨ 122.

**Lamps On Reminder**



This light comes on when the exterior lamps are in use, except when only the Daytime Running Lamps (DRL) are active. See *Exterior Lamp Controls* ⇨ 122.

## Cruise Control Light



The cruise control light is white when the cruise control is on and ready, and turns green when the cruise control is set and active.

## Adaptive Cruise Control Light



This light is white when the Adaptive Cruise Control (ACC, if equipped) is on and ready, and turns green when the ACC is set and active.

## Curve Speed Control Light



If equipped, this light may illuminate green when ACC is actively controlling the vehicle speed and detects a sharp curve on the road ahead.

ACC automatically slows the vehicle down while navigating the curve and may increase speed out of the curve, but will not exceed the set speed.

See *Adaptive Cruise Control (Advanced)*  
 ⇨ 203.

## Super Cruise Light



This light comes on to show the status of Super Cruise. See *Super Cruise* ⇨ 213.

## Door Ajar Light

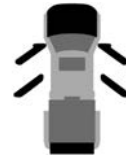

This light comes on when a door is open or not securely latched. Before driving, check that all doors are properly closed.

## Information Displays

### Charging

#### Important Information about Electric Vehicle Charging

- Charging an electric vehicle can stress a building's electrical system more than a typical household appliance.
- Charge cord limits can vary from vehicle to vehicle, and increased charging rates can stress a building's electrical system.
- Before plugging into any electrical outlet, have a qualified electrician inspect and verify the electrical system (electrical outlet, wiring, junctions, and protection devices) for heavy-duty service at a 12 amp continuous load.

- Electrical outlets may wear out with normal usage or may be damaged over time, making them unsuitable for electric vehicle charging.
- Check the electrical outlet/plug while charging and discontinue use if the electrical outlet/plug is hot, then have the electrical outlet serviced by a qualified electrician.
- When outdoors, plug into an electrical outlet that is weatherproof while in use.
- Mount the charging cord to reduce strain on the electrical outlet/plug.
- Do not place the charge cord in a position where it is expected to be submerged in water.

### Danger

Improper use of portable electric vehicle charge cords may cause a fire, electrical shock, or burns, and may result in damage to property, serious injury, or death.

- Do not use extension cords, multi-outlet power strips, splitters, grounding adapters, surge protectors, or similar devices.

(Continued)

### Danger (Continued)

- Do not use an electrical outlet that is worn or damaged, or will not hold the plug firmly in place.
- Do not use an electrical outlet that is not properly grounded.
- Do not use an electrical outlet that is on a circuit with other electrical loads.

### Energy App

The Energy app gives you access to features that will help you better understand and control how the vehicle manages energy. Along with providing a central location to determine and review your charging preferences, the Energy app offers live information on how the vehicle is using energy.

To launch the Energy app from the infotainment home screen, touch the Energy icon. There are four selections to choose from: Charging, Schedule, Energy Usage, and Settings. When you launch Energy for the first time, the Charging screen will display.

### Charging

To view the current charging status in the infotainment display, touch Charging.

On the Charging screen, there is a range of information associated with the next Charging session, as well as the ability to specify when you would like to charge the vehicle. The choices available to charge are Charge Now or Charge Later.

To create a charge schedule see “Creating a Charge Schedule” under “Schedule” below. The Charging screen shows and allows you to determine how the vehicle charges the next time it is plugged in.

### Charge Now

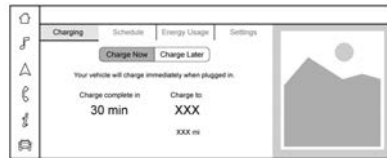

Charge Now is the default charging mode for your vehicle. The vehicle begins charging immediately when it is plugged in and authenticated at the charging location.

With Charge Now selected, the Charging screen displays:

- Text explaining that the vehicle will charge immediately when plugged in.

- **Charge Level:** The percentage to which you would like the vehicle to charge.
- **Charge Complete by/in:** The estimated time at which the vehicle will reach the desired Charge Level.
- An estimate of the vehicle's range upon completing the charging session.

The default charge level is 100% when plugged in. To set a different charge level, touch the percentage shown under Charge Level to display the Charge Level dialog.

### Warning

Do not charge your vehicle's battery above an 80% charge if you are going to drive down long, steep grades such as mountain passes. This provides room in the battery for regenerative braking to supplement your conventional brakes during the descent. This is especially important when towing a trailer, which puts additional stress on your vehicle's braking system.

See *Hill and Mountain Roads* ⇨ 174 for important information about driving on grades.

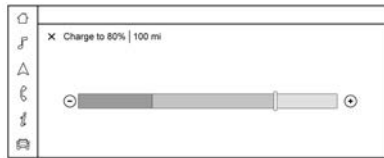

The Charge Level dialog displays:

- The Charge Level Gauge with a color-filled portion displaying the vehicle's current charge level. Use **−** and **+** or drag the marker to adjust the desired Charge Level.
- Range: An estimate of the vehicle's range upon reaching the Charge Level specified in this dialog.
- An **X** allowing you to close the Charge Level dialog. Settings made here are automatically saved when the dialog is exited.

To lower the desired Charge Level, drag the Charge Level marker to the left, and to increase it drag the marker to the right. The Charge Level percentage appears above your finger, updating in 5% increments as you drag. The Range estimate updates once the marker is released at the desired Charge Level. To optimize battery health, the minimum allowable Charge Level is determined by the vehicle. Touch **X** to exit

the Charge Level dialog and accept the changes. When the dialog closes, the charging information listed on the Charging screen is updated to reflect any changes made.

### Charge Later



Instead of charging immediately to a desired Charge Level, you may choose to delay the charge to the vehicle and have it complete by your desired departure time. This may be a more economical choice and a more efficient use of energy when charging at home. To use this mode, touch the Charge Later tab from the Charging screen.

With Charge Later selected, the Charging screen displays:

- Text explaining that your vehicle will delay the planned charge to be ready by the time specified.
- Charge Complete by: The time at which the vehicle will reach the desired Charge Level.

- **Charge Level:** The percentage to which you would like the vehicle to charge.
- **An estimate of the vehicle's range upon completing the charging session.**
- **Cabin Pre-Conditioning:** Allows the vehicle to heat or cool the cabin to your desired temperature using energy from the charger. This means energy from the battery is not used to condition the cabin, ensuring the vehicle gets the greatest range from the charging session. Cabin pre-conditioning happens at the end of the charge, and right before the departure time.

To set the time desired for the vehicle to complete charging, touch the time listed under Charge Complete By. This will display the Charge Complete By dialog.

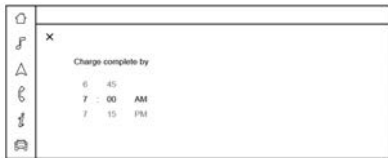

The Charge Complete By dialog displays:

- A time selector that allows you to specify the hour, the minutes in 15 minute increments at which the vehicle will reach the desired Charge Level.
- An **X** allowing you to close the Charge Complete By dialog. Settings made here are automatically saved when the dialog is exited.

Drag the appropriate sections of the time selector to set the Charge Complete By time. Touch **X** to exit the Charge Complete By dialog and accept the changes made. When the dialog closes, the charging information listed on the Charging screen will update to reflect any changes made. If the time specified does not allow the vehicle enough time to reach the desired Charge Level, a message displays and you can choose to alter either Charge Complete By time or desired Charge Level.

To adjust desired Charge Level in Charge Later mode, see “Charge Now” earlier in this section.

Setting the Cabin Pre-Conditioning preference:



Touch the switch to turn on Cabin Pre-conditioning. Cabin Pre-Conditioning temperature can be set in Settings, or by touching Cabin Pre-Conditioning on this screen.

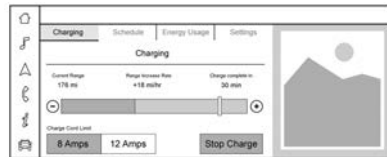

### Active Charging



During an active charging session, the Charging screen displays and continuously updates the following items:

- Text indicating the vehicle's current charging status.
- **Current Range:** The range the vehicle is capable of driving at the current charge level.
- **Range Increase Rate:** How much range is accumulating per hour of charging.
- **Charge Complete at/in:** The estimated time at which the vehicle will reach the desired Charge Level.

- The Charge Level Gauge with a portion displaying the vehicle's current charge level. Use  and  or drag the white marker to adjust the desired Charge Level.

To update the desired Charge Level for the active charging session, drag the marker on the Charge Level Gauge or touch the  and .

Touching the Stop Charge button at any time ends the active charging session and presents a summary of the current vehicle Range, Charge Level, and amount of Range Gained during the charging session. For information on beginning a charging session, see *Plug-In Charging* ⇨ 253.

For Level 1 chargers, you can also select the appropriate Charge Cord Limit of either 8 amps or 12 amps. This determines how much current can flow from an electrical outlet to the vehicle battery. It also ensures proper charge time estimates.

When the Charge Cord Limit is changed from 8 amps to 12 amps on a 120V circuit a notification is displayed.

If no Home Charge Location is set, the Level 1 Cord Limit will revert to 8 amps every time the vehicle is shifted out of (P) Park.

Range and charge time estimates fluctuate depending on a number of factors such as Charge Cord Level/Limit, battery temperature, and outside air temperature. To learn more about the vehicle battery see *Plug-In Charging* ⇨ 253.

To monitor your vehicle's charging status from outside the vehicle, turn on the Headlight Charge Indicator in the Settings screen. The peek-in charging screen can be used to monitor your vehicle's charge status, see *Instrument Cluster* ⇨ 94. To monitor the charging status remotely, download the myGMC app on your mobile device.

### DC Fast Charging

The vehicle will immediately begin charging when plugged into a DC fast charging station. While DC Fast Charging, the vehicle will bypass any schedule or departure time selection. See *Plug-In Charging* ⇨ 253.

The Station Power gauge displays the station's ability to charge at the rate your vehicle is capable of charging. If you see the Station Power gauge at the bottom of the peek-in screen when you are Fast Charging, the station you are using is not providing as much power as your vehicle is capable of receiving. If you regularly see this gauge at

a particular station, consider using another Fast Charging station, or you can try calling the station support line if one is displayed.

Reasons the Station Power gauge may appear, include when:

- The station is unable to provide the amount of energy that your vehicle can handle.
- Multiple vehicles are charging at the same time and may be affecting the charge rate.
- Power is being limited at the charger.

### Schedule

The Energy app's Schedule feature allows a custom charging plan to be set for each day of the week. When the vehicle is plugged in at the Home Charge Location, the Schedule feature will automatically charge to the desired Charge Level and pre-condition the cabin by the time set in the Schedule. This feature acts as a more customizable Charge Later setting than the one on the Charging screen.

## Creating a Schedule



To create a Schedule, touch the Create Schedule card on the left. If there is no Home Charge Location set you will be prompted to create one.

The Charging Schedule dialog displays:

- Toggles for each day of the week.
- Charge to: A value selector for setting the desired Charge Level.
- Complete by: A time selector for setting the time the vehicle will reach the desired Charge Level.
- Cabin Pre-Conditioning: Allows the vehicle to heat or cool the cabin to the desired temperature by using energy from the charger.
- An **X** allowing you to close the Charging Schedule dialog.
- Save & Close button: Applies any changes made and exits the dialog.

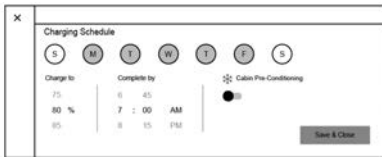

Days can be assigned to the Schedule. Days of the week represented by their first letter in circular toggles. Touching each toggle illuminates the graphic, confirming that day is assigned to the Schedule. Touching a second time unassigns days from this Schedule, dimming the toggle once again. Select all days to adhere to the settings in this Schedule. If there are multiple charge schedules, days must be unassigned from their current Schedule before they can be assigned to a new one.

Once completed with the charging Schedule, touch the Save & Close button to finish creating the schedule.

On days that are not assigned a Schedule, the vehicle will begin charging to 100% as soon as it is plugged in, unless otherwise specified on the Charging screen.

Home Charge Schedule can be turned ON or OFF. To enable or disable all charging Schedules, touch the toggle switch next to Home Charge Schedule on the Schedule screen.

## Modifying and Deleting Charge Schedules



To modify a Schedule, touch the card on the Schedule screen. This will open a dialog. Make the desired changes and then touch the Save & Close button when finished. To delete the Schedule, simply touch the Delete Schedule button, at which point you will be prompted to confirm your decision.

## Charge Settings

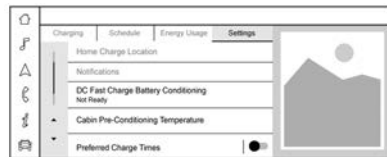

To view and change the Charge Settings, touch Settings. Use the arrows to scroll through the list, or hold and drag the list.

This screen allows preferences to be set with regards to how the vehicle charges. Touching any item will display options for specifying their behavior.

The Settings screen displays:

### **Home Charge Location**

With a Home Charge Location set, the vehicle can determine whether it is plugged in at home, and will charge according to any existing schedules. The Home Charge Location can be changed or deleted at this screen.

The wireless service and GPS satellite technologies must be available and operating for features to function properly. These systems may not operate if the battery is disconnected, or if the vehicle has been off for an extended period of time. If GPS is unavailable, a message displays on the infotainment screen. GPS functionality may resume after the next time you drive the vehicle.

### **Notifications**

This section contains on/off preferences for multiple notifications triggered during the Charging session.

**Charge Status Feedback** : Provides an audible notification through horn chirps that accompany changes in the charging status.

**Charge Power Loss Alert** : When on, your vehicle will chirp for an extended period of time if charging power is cut off.

**Headlight Charge Status Indicator** : When on, your vehicle's headlights will show the charging status. As the battery charges, more LED bars within the headlights will turn on. The headlights will automatically turn off when charging is complete.

### **DC Fast Charge Battery Conditioning**

Adjusts the battery to the optimal temperature for quicker DC Fast Charging. This should be done before charging at a DC Fast Charger.

Depending on the outside and battery temperature, battery conditioning could be as long as one hour.

While en route using Google Maps, DC Fast Charge Conditioning happens automatically if a DC Fast Charge station has been added to the route.

### **Cabin Pre-Conditioning Temperature**

Allows for the preferred cabin temperature to be set. During your next charging session, the vehicle cabin is warmed or cooled to this temperature if Pre-conditioning is set to ON in either the Charge Later screen, or in an active Schedule.

### **Preferred Charge Times**

Allows preferred charge time windows to be enabled for the Home Charge Location during both weekday and weekend scheduled or delayed charging sessions. This allows for charging at a lower cost by charging during the electrical provider's off-peak period. The vehicle will use these times to reach the desired Charge Level by the scheduled time. If the vehicle cannot reach the desired charge level within these times, it will charge as needed outside of this schedule.



## Energy Information

### Energy Usage

To view Energy Usage, touch Energy Usage on the infotainment display.

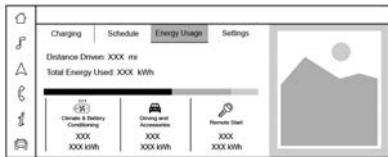

This screen displays how energy is being used for the current drive since the last time the vehicle was started.

The Energy Usage screen displays:

**Distance Driven** : The distance of your current Trip.

**Total Energy Used** : The amount of energy used during your current Trip, shown in Kilowatt Hours (kWh).

**i** : For displaying more information about your vehicle's Energy Usage.

**Energy Usage Bar Diagram** : A visual representation of the percentage of total energy being used by each Energy Usage Category.

**Energy Usage Categories** : Climate & Battery Conditioning, Driving & Accessories, and Remote Start.

Tap **i** or any Energy Usage Category to learn more about how your vehicle uses energy from the battery.

### Driver Information Center (DIC)

The DIC is displayed in the instrument cluster. It shows the status of many vehicle systems. The controls for the DIC are on the right steering wheel control. See *Instrument Cluster* ⇨ 94.

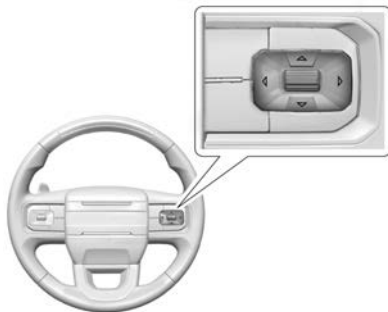

**△ or ▽** : Move up or down in a list.

**◀ or ▶** : Press to move between the interactive display zones in the instrument cluster.

**△ / ▽ Switch** : Press to open a menu or select a menu item. Press and hold to reset values on certain screens.

### DIC Info Page Options

The info pages on the DIC can be turned on or off through the Options menu.

1. Press **◀** to access the instrument cluster applications.
2. Move **△** or **▽** through the list of available applications.
3. Press to select the application, then press **▶** to enter the application menu.
4. Move **△** or **▽** to move through the list of possible information displays.
5. Press the **△ / ▽** switch while an item is highlighted to select or deselect that item.

When an item is selected, a checkmark appears next to it.

## DIC Info Pages

The following is the list of all possible DIC info page displays. Some may not be available for your particular vehicle. Some items may not be turned on by default but can be turned on through the Options app. See "DIC Info Page Options" earlier in this section.

**Trip 1 or Trip 2 and Average Efficiency** : The Trip display shows the current distance traveled, in either kilometers (km) or miles (mi), since the trip odometer was last reset.

The Average Efficiency shows the approximate average kilometers per kilowatt hour kWh (km/kWh) or miles per kilowatt hour kWh(mi/kWh). This number is calculated based on the number of km/kWh or mi/kWh recorded since the last time this menu item was reset. This number only reflects the approximate average electrical energy economy that the vehicle has at that moment, and changes as driving conditions change.

The values can be reset by pressing and holding the  $\triangle / \nabla$  switch while either the Trip 1 or the Trip 2 display is active.

**Timer** : To start the timer, press the  $\triangle / \nabla$  switch while this display is active. The display will show the amount of time that has passed since the timer was last reset. To stop the timer, press the  $\triangle / \nabla$  switch briefly while this display is active and the timer is running. To reset the timer to zero, press and hold the  $\triangle / \nabla$  switch while this display is active.

**Tire Pressure** : Shows the approximate pressures of all four tires. Tire pressure is displayed in either kilopascal (kPa) or in pounds per square inch (psi). If the pressure is low, the value for that tire is shown in amber. Pressing and holding the  $\triangle / \nabla$  switch displays a series of alerts for Tire Manual Learning.

**Driver Assistance** : If equipped, shows information for Adaptive Cruise Control (ACC), Follow Distance, Lane Keep Assist (LKA) and Forward Collision Alert (FCA).

**Trailer Brake** : On vehicles with the Integrated Trailer Brake Control (ITBC) system, this display appears in the DIC.

TRAILER GAIN shows the trailer gain setting. This setting can be adjusted from 0.0 to 10.0 with either a trailer connected or disconnected.

TRAILER OUTPUT shows the power output to the trailer any time a trailer with electric brakes is connected. Output is displayed as a bar graph. Dotted lines may appear in the OUTPUT display if a trailer is not connected.

**Off Road** : Displays vehicle pitch and roll information, road wheel angle, and four-wheel drive (e4WD) status.

**Energy Usage** : Shows energy usage of the Driving, Remote Start, Climate and Conditioning vehicle systems as percentages of overall vehicle energy use.

**Suspension Travel** : Shows a graphical representation of the current wheel travel upward or downward for all four wheels as the vehicle travels over uneven terrain. The wheel color shown on this display becomes more saturated as the suspension reaches max upward or downward travel. When ride height is adjusted up or down the wheel positions in this graphic shows above or below normal ride height on level ground.

**Blank Page** : No information is displayed in the cluster info display areas.

**Info Page Options** : Press the  $\triangle / \nabla$  switch to select the items to be displayed in the Info app. See *Driver Information Center (DIC)* ⇨ 116.

## Vehicle Messages

Messages displayed on the DIC indicate the status of the vehicle or some action that may be needed to correct a condition. Multiple messages may appear one after another.

Press the  $\triangle$  /  $\nabla$  switch on the steering wheel to acknowledge and clear messages that do not require immediate action. The messages that require immediate action cannot be cleared until that action is performed.

All messages should be taken seriously; clearing the message does not correct the problem.

If a SERVICE message appears, see your dealer.

Follow the instructions given in the messages. The system displays messages regarding the following topics:

- Service Messages
- Fluid Levels
- Vehicle Security
- Brakes
- Ride Control Systems
- Driver Assistance Systems

- Cruise Control
- Lighting and Bulb Replacement
- Wiper/Washer Systems
- Doors and Windows
- Seat Belts
- Airbag Systems
- Propulsion
- Tire Pressure
- Battery
- Steering

### Propulsion Power Messages

#### REDUCED ACCELERATION DRIVE WITH CARE

This message displays when the vehicle's propulsion power is reduced. A reduction in propulsion power can affect the vehicle's ability to accelerate. If this message is on, but there is no observed reduction in performance, proceed to your destination. Under certain conditions, the performance may be reduced the next time the vehicle is driven. The vehicle may be driven while this message is on, but maximum acceleration and speed may be reduced. Anytime this message stays on, or displays repeatedly, the vehicle should be taken to your dealer for service as soon as possible.

This message can be displayed when the high voltage battery charge level is low. This is normal behavior as the vehicle is limiting power due to reduced battery capability with a low charge.

Under certain operating conditions propulsion will be disabled. Try restarting after the vehicle has been off for two minutes.

#### PROPULSION POWER REDUCED DUE TO TEMPERATURE

This message displays when the vehicle is on, the battery temperature is low, and when the vehicle's performance is limited. The duration of the limited vehicle performance depends, in part, on the high voltage battery charge level. If the high voltage battery charge level is relatively high, as the vehicle is driven, the battery temperature will increase, and the vehicle will return to normal operation. If the high voltage battery charge level is relatively low the vehicle will not return to normal operation until charged.

Keep the vehicle plugged in, even when fully charged, to keep the high voltage battery temperature ready for the next drive. This is important when outside temperatures are extremely hot or cold.

## Vehicle Speed Messages

### SPEED LIMITED TO XXX KM/H (MPH)

This message shows that the vehicle speed has been limited to the speed displayed. The limited speed is a protection for various propulsion and vehicle systems, such as lubrication, thermal, brakes, suspension, Teen Driver if equipped, or tires.

## Universal Remote System

See *Radio Frequency Statement* ⇨ 374.

## Universal Remote System Programming



If equipped, these buttons are in the sunshade.

This system can replace up to three remote control transmitters used to activate devices such as garage door openers, security systems, and home automation devices. These instructions refer to a garage door opener, but can be used for other devices.

Do not use the Universal Remote system with any garage door opener that does not have the stop and reverse feature. This includes any garage door opener model manufactured before April 1, 1982.

Keep the original hand-held transmitter for use in other vehicles as well as for future programming. Erase the programming when

vehicle ownership is terminated. See “Erasing Universal Remote System Buttons” later in this section.

To program a garage door opener, park outside directly in line with and facing the garage door opener receiver. Clear all people and objects near the garage door.

Make sure the hand-held transmitter has a new battery for quick and accurate transmission of the radio-frequency signal.

### Programming the Universal Remote System

Programming involves time-sensitive actions and may time out, requiring the procedure to be repeated. Read these instructions completely before programming the Universal Remote system. It may help to have another person assist with the programming process.

1. Hold the end of the hand-held transmitter about 3 to 8 cm (1 to 3 in) away from the Universal Remote system buttons with the indicator light in view. The hand-held transmitter was supplied by the manufacturer of the garage door opener receiver.

2. Press and release one of the three Universal Remote system buttons to be programmed. Press and hold the hand-held transmitter button. Do not release the hand-held transmitter button until the indicator light changes from a slow to a rapid flash or continuous light. Then release the hand-held transmitter button.

Some garage door openers may require substitution of Step 2 with the procedure under “Radio Signals for Some Gate Operators” later in this section.

3. Press and hold the newly programmed Universal Remote system button for five seconds while watching the indicator light and garage door activation.

- If the indicator light stays on continuously or the garage door moves when the button is pressed, then programming is complete. There is no need to complete Steps 4–6.
- If the indicator light does not come on or the garage door does not move, a second button press may be required. For a second time, press and hold the newly programmed button for five seconds. If the indicator light stays on continuously

or the garage door moves when the button is pressed, then programming is complete. There is no need to complete Steps 4–6.

- If the garage door does not move, continue with programming Steps 4–6.

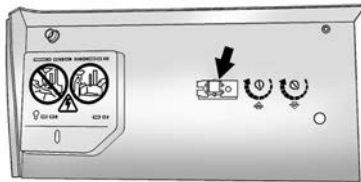

#### Learn or Smart Button

4. After completing Steps 1–3, locate the Learn or Smart button inside garage on the garage door opener receiver. The name and color of the button may vary by manufacturer.
5. Press and release the Learn or Smart button. Step 6 must be completed within 30 seconds of pressing this button.
6. Return to the vehicle and firmly press and hold the trained Universal Remote system button for two seconds and

release. Repeat the “press/hold/release” sequence up to three times to complete the training process.

The Universal Remote system should now activate the garage door. Repeat the process for programming the remaining two buttons.

For questions or programming help, see [www.homelink.com/gm](http://www.homelink.com/gm) or call 1-800-355-3515. For calls placed outside the U.S., Canada, or Puerto Rico, international rates will apply and may differ based on landline or mobile phone.

#### Radio Signals for Some Gate Operators

Some gate operators and radio-frequency laws require transmitter signals to time out or quit after several seconds of transmission. This may not be long enough for the Universal Remote system to pick up the signal during programming.

If the programming did not work, replace Step 2 under “Programming the Universal Remote System” with the following:

Press and hold the Universal Remote system button while pressing and releasing the hand-held transmitter button every two seconds until the signal has been

successfully accepted by the Universal Remote system. The Universal Remote system indicator light will flash slowly at first and then change to a rapid flash or continuous solid-light. Proceed with Step 3 under “Programming the Universal Remote System” to complete.

## Universal Remote System Operation

### Using the Universal Remote System

Press and hold the appropriate Universal Remote system button for at least one-half second. The indicator light will come on while the signal is being transmitted.

### Erasing Universal Remote System Buttons

Erase all programmed buttons when vehicle ownership is terminated.

To erase:

1. Press and hold the two outside buttons until the indicator light begins to flash. This should take about 10 seconds.
2. Release both buttons.

### Reprogramming a Single Universal Remote System Button

To reprogram any of the system buttons:

1. Press and hold any one of the buttons. Do not release the button.
2. The indicator light will begin to flash after 20 seconds. Without releasing the button, proceed with Step 1 under “Programming the Universal Remote System.”

## Lighting

### Exterior Lighting

Exterior Lamp Controls .....	122
Exterior Lamps Off Reminder .....	123
Headlamp High/Low-Beam Changer ....	123
Flash-to-Pass .....	123
Daytime Running Lamps (DRL) .....	124
Automatic Headlamp System .....	124
Hazard Warning Flashers .....	125
Turn and Lane-Change Signals .....	125
Exterior Cargo Lamps .....	125

### Interior Lighting

Instrument Panel Illumination Control .....	126
Dome Lamps .....	126
Reading Lamps .....	127

### Lighting Features

Entry Lighting .....	127
Exit Lighting .....	127
Battery Load Management .....	128
Battery Power Protection .....	128
Exterior Lighting Battery Saver .....	128

## Exterior Lighting

### Exterior Lamp Controls



The exterior lamp control is on the turn signal lever.

Turn the control to the following positions:

: Turns off the exterior lamps and deactivates AUTO mode. The knob returns to the AUTO position after it is released. Turn to again to reactivate AUTO mode.

For vehicles first sold in Canada, the headlamps will automatically reactivate when the vehicle is shifted out of P (Park).

**AUTO** : Automatically turns the exterior lamps on and off, depending on outside lighting.

: Turns on all lamps, except the headlamps.

: Turns on the headlamps, parking lamps, and instrument panel lights.

### IntelliBeam System

This system turns the high-beam headlamps on and off according to surrounding traffic conditions.

The system turns the high-beam headlamps on when it is dark enough and there is no other traffic present.

This light appears in the instrument cluster when the IntelliBeam system is enabled.

### Turning On and Enabling IntelliBeam



To enable the IntelliBeam system, press the button on the end of the turn signal lever when the exterior lamp control is in the AUTO or position.

### Driving with IntelliBeam

The system only activates the high beams when driving over 40 km/h (25 mph).

The blue high-beam on light appears on the instrument cluster when the high beams are on.

There is a sensor near the top center of the windshield that automatically controls the system. Keep this area of the windshield clear of debris to allow for best system performance.

The high-beam headlamps remain on, under the automatic control, until one of the following situations occurs:

- The system detects an approaching vehicle's headlamps.
- The system detects a preceding vehicle's taillamps.
- The outside light is bright enough that high-beam headlamps are not required.
- The vehicle speed drops below 20 km/h (12 mph).

The IntelliBeam system is disabled by the button on the turn signal lever. If this happens, press the button on the end of the turn signal lever when the exterior lamp control is in the AUTO or  position. The

instrument cluster light will come on to indicate the IntelliBeam system is reactivated.

The high beams may not turn off automatically if the system cannot detect another vehicle's lamps because of any of the following:

- The other vehicle's lamps are missing, damaged, obstructed from view, or otherwise undetected.
- The other vehicle's lamps are covered with dirt, snow, and/or road spray.
- The other vehicle's lamps cannot be detected due to dense exhaust, smoke, fog, snow, road spray, mist, or other airborne obstructions.
- The windshield is dirty, cracked, or obstructed by something that blocks the view of the light sensor.
- The vehicle is loaded such that the front end points upward, causing the light sensor to aim high and not detect headlamps and taillamps.
- The vehicle is being driven on winding or hilly roads.

The automatic high-beam headlamps may need to be disabled if any of the above conditions exist.

### Exterior Lamps Off Reminder

A warning chime sounds if the driver door is opened while the vehicle is off and the exterior lamps are on.

### Headlamp High/Low-Beam Changer

Push the turn signal lever away from you and release, to turn the high beams on. To return to low beams, push the lever again or pull it toward you and release.



This indicator light turns on in the instrument cluster when the high-beam headlamps are on.

### Flash-to-Pass

To flash the high beams, pull the turn signal lever toward you, and release.



## Daytime Running Lamps (DRL)

DRL can make it easier for others to see the front of your vehicle during the day.

Fully functional DRL are required on all vehicles first sold in Canada.

The DRL come on when all of the following conditions are met:

- The vehicle is on.
- The exterior lamp control is in AUTO.
- The light sensor determines it is daytime.

The taillamps, instrument panel lights, and other lamps will not turn on when this feature is activated.

The DRL turn off when the headlamps are turned to  or the vehicle is off.

For vehicles first sold in Canada, the DRL can only be turned off when the vehicle is parked.

## Automatic Headlamp System

When the exterior lamp control is set to AUTO and it is dark enough outside, the headlamps come on automatically.

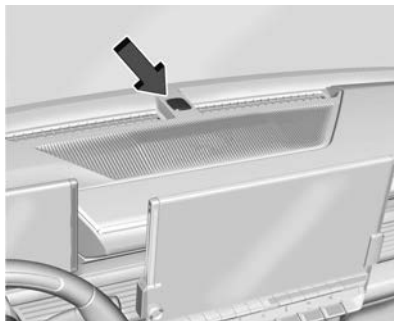

There is a light sensor on top of the instrument panel. Do not cover the sensor.



The system may also turn on the headlamps when driving through a parking garage or tunnel.

If the vehicle is started in a dark garage, the automatic headlamp system comes on immediately. If it is light outside when the vehicle leaves the garage, there is a slight delay before the automatic headlamp system changes to the Daytime Running Lamps (DRL). During that delay, the instrument cluster may not be as bright as usual. Make sure the instrument panel brightness control is in the full bright position. See *Instrument Panel Illumination Control* ⇨ 126.

When it is bright enough outside, the headlamps will turn off or may change to DRL.

The automatic headlamp system turns off when the exterior lamp control is turned to  or the vehicle is off.

## Lights On with Wipers

If the windshield wipers are activated in daylight with the vehicle on, and the exterior lamp control is in AUTO, the headlamps, parking lamps, and other exterior lamps come on. The transition time for the lamps coming on varies based on wiper speed. When the wipers are not operating, these lamps turn off. Move the exterior lamp control to  or  to disable this feature.

## Hazard Warning Flashers

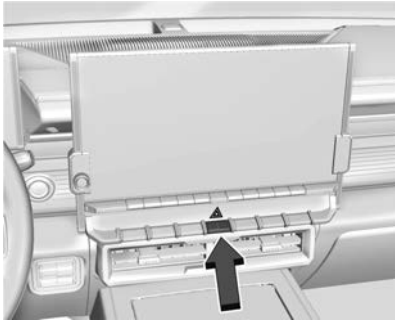

 : Press this button to make the front and rear turn signal lamps flash on and off. This warns others that you are having trouble. Press again to turn the flashers off.

The turn signals do not work while the hazard warning flashers are on.

The hazard warning flashers turn on automatically if the airbags deploy.

## Turn and Lane-Change Signals

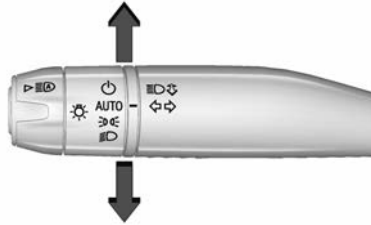

Move the lever all the way up or down to signal a turn.

An arrow on the instrument cluster will flash in the direction of the turn or lane change.

Raise or lower the lever until the arrow starts to flash to signal a lane change. Hold it there until the lane change is complete. If the lever is moved momentarily to the lane change position, the arrow will flash three times. It will flash six times if Tow/Haul Mode is active.

The lever returns to its starting position when it is released.

If after signaling a turn or lane change, the arrow flashes rapidly or does not come on, a signal LED may be burned out.

If a LED is not burned out, check the fuse. See *Instrument Panel Fuse Block (Right)* ⇨ 312 or *Instrument Panel Fuse Block (Left)* ⇨ 310.

See your dealer for service.

## Exterior Cargo Lamps



The cargo lamps provide more light in the cargo area or on the sides of the vehicle, if needed. The lamps inside the pickup box, in the tailgate handle, for the hitch, and/or the cargo mirror lamps also turn on, if equipped.

If the vehicle is in P (Park), R (Reverse), or N (Neutral), the cargo lamp switch causes the lights to cycle through the following states for each button press:

**Initial Press:**

- Cargo Bed Lights – On
- Cargo Mirror Lights – On
- Cargo Switch Indicator (if equipped) – On

**Next Press: (if within 5 seconds of the previous button press):**

- Cargo Bed Lights – On
- Cargo Mirror Lights – Off
- Cargo Switch Indicator (if equipped) – On

**Next Press:**

- Cargo Bed Lights – Off
- Cargo Mirror Lights – Off
- Cargo Switch Indicator (if equipped) – Off

Become familiar with and follow all state and local laws that apply to cargo lamp operation.

## Interior Lighting

### Instrument Panel Illumination Control

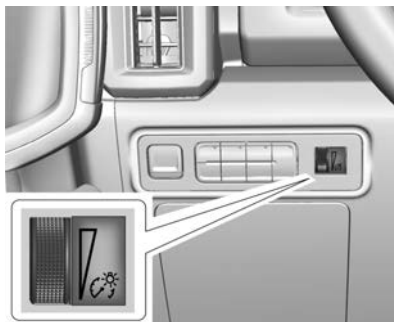

This feature adjusts the brightness of all illuminated controls.

 : Move the thumbwheel up or down to brighten or dim the lights.



The thumbwheel is functional at night, or when the headlamps or parking lamps are on.



### Dome Lamps

The dome lamps and dome lamp controls are in the overhead console.



To operate, press the following buttons:

 : Press to turn the lamps off, even when any door is opened,  on the remote key is pressed, or when the vehicle is turned off.

 : When the button is returned to the middle position, the lamps turn on automatically when any door is opened,  on the remote key is pressed, or when the vehicle is turned off.

 : Press to turn the dome lamps on manually.

## Reading Lamps

There are reading lamps on the overhead console and over the rear seats. These lamps come on when any doors are opened.



Front Reading Lamps

The front reading lamps are in the overhead console.

Press or to turn the front reading lamps on or off.

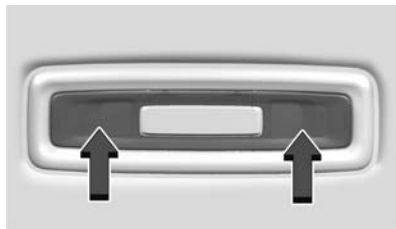

Rear Reading Lamps

The rear reading lamps are above and behind the rear seats.

Press the lamp lens to turn the rear reading lamps on or off.

## Lighting Features

### Entry Lighting

The interior lamps turn on when pressing on the remote key or opening any doors, and the dome lamp control is in the door position.

Some exterior lamps also turn on when pressing on the remote key or opening any doors. Low-Beam lamps will only turn on briefly at night, or in areas with limited lighting.

All lamps will gradually fade out after about 30 seconds.

Entry lighting can be disabled manually by closing all doors, pressing on the remote key, or starting the vehicle.

This feature can be changed. On the infotainment home page, select the Settings icon > Vehicle > Vehicle Locator Lights.

### Exit Lighting

Some exterior lamps and interior lamps turn on when the driver door is opened after the vehicle is turned off.

The exterior and interior lamps remain on for a set amount of time, then automatically turn off.

The interior lights turn on when the vehicle is turned off.

The exterior lamps turn off immediately by turning the exterior lamp control off.

This feature can be changed. On the infotainment home screen, select the Settings icon > Vehicle > Exit Lighting.

## Battery Load Management

The vehicle has Electric Power Management (EPM) that estimates the battery temperature and state of charge. It then adjusts the voltage for best performance and extended life of the 12-volt battery.

When the battery state of charge is low, the voltage is raised slightly to quickly increase the charge. When the state of charge is high, the voltage is lowered slightly to prevent over charging. As this adjustment occurs, you may see the voltage move up or down on the voltmeter gauge or voltage display on the Driver Information Center (DIC), if equipped. This is normal. If a problem occurs, an alert will be displayed.

If the electrical loads are very high, the battery can be discharged when the vehicle is stationary. A high electrical load occurs when several features are on, such as: headlamps, high beams, rear window defogger, climate control fan at high speed, heated seats, motor cooling fans, trailer loads, and loads plugged into accessory power outlets.

EPM works to prevent excessive discharge of the battery by balancing the electrical system output and the vehicle's electrical

needs. In some cases, it can temporarily reduce the power demands of some accessories.

These actions occur in steps or levels without being noticeable. In rare cases at the highest levels of corrective action, this action may be noticeable to the driver. If so, a DIC battery voltage and charging message displays. It is recommended that the driver reduce the electrical loads as much as possible. See *Driver Information Center (DIC)* ⇨ 116.



## Battery Power Protection

This feature helps prevent the battery from being drained if the interior courtesy lamps or reading lamps are accidentally left on. If any of these lamps are left on, they automatically turn off after 10 minutes when the vehicle is turned off. The lamps will not come back on again until one of the following occurs:

- The vehicle is started.
- The doors are closed and then re-opened.

## Exterior Lighting Battery Saver

The exterior lamps turn off about 10 minutes after the vehicle is turned off, if the parking lamps or headlamps have been manually

left on. This protects against draining the battery. To restart the 10-minute timer, turn the exterior lamp control to the  position and then back to the  or  position.

To keep the lamps on for more than 10 minutes, the vehicle must be on.

# Infotainment System

## Introduction

Introduction .....	129
Overview .....	130
Steering Wheel Controls .....	130
Using the System .....	131
Software Updates .....	134

## Radio

AM-FM Radio .....	134
Satellite Radio .....	135
Radio Reception .....	136
Multi-Band Antenna .....	136

## Audio Players

Avoiding Untrusted Media Devices ....	136
USB Port .....	136
Bluetooth Audio .....	137

## Navigation

Using the Navigation System .....	137
Maps .....	138
Navigation Symbols .....	138
Destination .....	139
Global Positioning System (GPS) .....	140
Vehicle Positioning .....	140
Problems with Route Guidance .....	140

## Voice Recognition

Voice Recognition .....	141
-------------------------	-----

## Phone

Bluetooth (Overview) .....	142
Bluetooth (Pairing and Using a Phone) .....	143
Apple CarPlay and Android Auto .....	147

## Settings

Settings .....	148
Teen Driver .....	150

## Trademarks and License Agreements

Trademarks and License Agreements ...	153
---------------------------------------	-----

## Introduction

Read the following pages to become familiar with the features.

### Warning

Taking your eyes off the road for too long or too often while using any infotainment feature can cause a crash. You or others could be injured or killed. Do not give extended attention to infotainment tasks while driving. Limit your glances at the vehicle displays and focus your attention on driving. Use voice commands whenever possible.

The infotainment system has built-in features intended to help avoid distraction by disabling some features when driving. These features may gray out when they are unavailable. Many infotainment features are also available through the instrument cluster and steering wheel controls.

Before driving:

- Become familiar with the operation, center stack controls, steering wheel controls, and infotainment display.

- Set up the audio by presetting favorite stations, setting the tone, and adjusting the speakers.
- Set up phone numbers in advance so they can be called easily by pressing a single control or by using a single voice command.

See *Distacted Driving* ⇨ 163.

### Overview

#### Infotainment System

The infotainment system is controlled by using the infotainment display, controls on the center stack, steering wheel controls, and voice recognition if available.

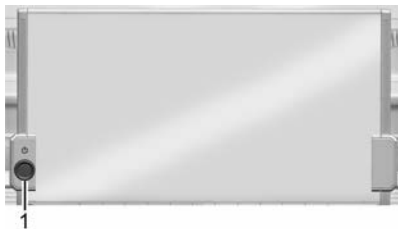

1.  (Power)
  - Press to turn the power on.

- Press and hold to turn the power off.
- Press to mute/unmute the system when on.
- Turn to decrease or increase the volume.

#### Home Page

The Home Page is where vehicle application icons are accessed. Some applications are disabled when the vehicle is moving.

Swipe left or right across the display to access the pages of icons.

Card view is located on the right side of the screen. Scroll up and down through the different cards. Individual cards can not be added or deleted. For most of the apps in the cards, an open card view app will temporarily not be shown in card view.

#### Managing Home Page Icons

1. Touch and hold any of the Home Page icons to enter edit mode.
2. Continue holding the icon and drag it to the desired position.
3. Release your finger to drop the icon in the desired position.

#### Move an Icon to Another Page

1. Drag the icon to the edge of the display toward the desired page.
2. Continue dragging and dropping application icons as desired.

#### Move an Icon to the Application Tray

To move an icon to the application tray on the left side of the screen, drag the icon to the applications tray.

#### Steering Wheel Controls

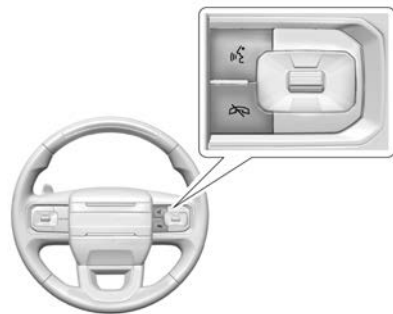

If equipped, some audio controls can be adjusted at the steering wheel.

 : Press to answer an incoming call or start voice recognition. See *Bluetooth (Pairing and Using a Phone)* ⇨ 143 or *Bluetooth (Overview)* ⇨ 142.

 : Press to decline an incoming call or end a current call, mute or unmute the infotainment system when not on a call, or end a voice recognition session.

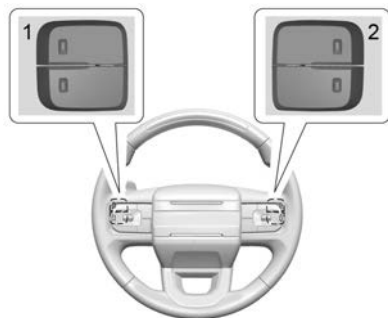

The favorites and volume switches are on the back of the steering wheel.

1. Favorite: When on a radio source, press to select the next or previous audio broadcast favorite. When listening to a media device, press to select the next or previous track.

2. Volume: Press to increase or decrease the volume.

## Using the System

### Phone

Touch the Phone icon to display the Phone main page. See *Bluetooth (Pairing and Using a Phone)* ⇨ 143 or *Bluetooth (Overview)* ⇨ 142.

### Audio

Touch the Audio icon to display the audio screen. See *AM-FM Radio* ⇨ 134, *Satellite Radio* ⇨ 135, and *Bluetooth Audio* ⇨ 137.

### Wi-Fi Hotspot

Touch the Wi-Fi Hotspot icon to display the Wi-Fi Hotspot screen. See “Wi-Fi Hotspot” in *Settings* ⇨ 148.

### Maps

Touch the Maps icon to display the Google Maps screen. See *Using the Navigation System* ⇨ 137.

### Google Assistant

Touch the Google Assistant icon to open the Google Assistant app. See *Voice Recognition* ⇨ 141.

### Google Play

Touch to download some of your favorite apps in your vehicle. Downloading apps on Google Play require you to sign into a Google Account with an active service plan with data. Some third-party apps require a separate account and, in some cases, a paid subscription for in-vehicle access.

### Energy

Touch the Energy icon to open the Energy app. See *Energy Information* ⇨ 116.

### My GMC Studio

Touch the My GMC Studio icon when in park and select a desired streaming service. To use this feature, an active GMC Connected Services plan with vehicle data or a mobile device hotspot must be used as a data source.

### Off-Road App

Touch the Off-Road icon to open the Off-Road app. See *Off-Road App* ⇨ 170.

### Trailer

Touch the Trailing icon to display the Trailing App. See *Trailing App* ⇨ 279.



**Settings**

Touch the Settings icon to display the Settings menu. See *Settings* ⇨ 148.

**Rear Climate**

Touch the Climate icon to display the Climate Control Display. See *Dual Automatic Climate Control System* ⇨ 156.

**Apple CarPlay**

Touch the Apple CarPlay icon to activate Apple CarPlay (if equipped) after a supported device is connected. See *Apple CarPlay and Android Auto* ⇨ 147.

**Android Auto**

Touch the Android Auto icon to activate Android Auto (if equipped) after a supported device is connected. See *Apple CarPlay and Android Auto* ⇨ 147.

**Cameras**

If equipped, touch the Camera icon to access the camera application. See *Surround Vision System* ⇨ 229.

**Shortcut Menu**

The shortcut menu is along the left edge of the display. It shows up to five applications. To change the applications shown on the shortcut menu, touch and hold an icon and then drag it from the home page to the shortcut menu.

**Infotainment Display Features**

Infotainment display features show on the display when available. When a feature is unavailable, it may gray out. When a feature is touched, it may highlight.

**Haptic Feedback**

If equipped, haptic feedback is a pulse that occurs when an icon or option is touched on the display or when controls on the center stack are pressed.

**Infotainment Gestures**

Use the following finger gestures to control the infotainment system.

**Touch/Tap**

Touch/tap is used to select an icon or option, activate an application, or change the location inside a map.

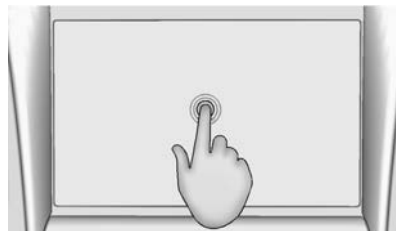
**Touch and Hold**

Touch and hold can be used to start another gesture, or to move or delete an application.

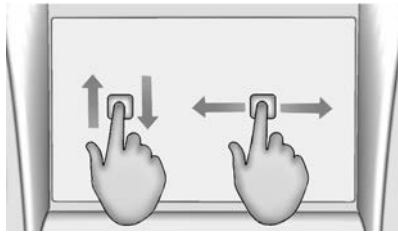
**Drag**

Drag is used to move applications on the Home Page, or to pan the map. To drag the item, it must be held and moved along the display to the new location. This can be done up, down, right, or left. This feature is only available when the vehicle is parked and not in motion.

**Nudge**

Nudge is used to move items a short distance on a list or a map. To nudge, hold and move the selected item up or down to a new location.

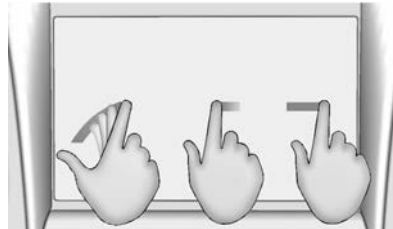
**Fling or Swipe**

Fling or swipe is used to scroll through a list, pan the map, or change page views. Do this by placing a finger on the display then moving it rapidly up and down or right and left.

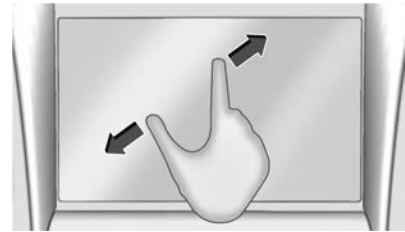
**Spread**

Spread is used to zoom in on a map, certain images, or a web page. Place finger and thumb together on the display, then move them apart.

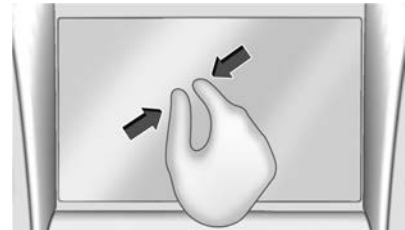
**Pinch**

Pinch is used to zoom out on a map, certain images, or a web page. Place finger and thumb apart on the display, then move them together.

## Cleaning High Gloss Surfaces and Vehicle Information and Radio Displays

For vehicles with high gloss surfaces or vehicle displays, use a microfiber cloth to wipe surfaces. Before wiping the surface with the microfiber cloth, remove dirt that could scratch the surface. Then use the microfiber cloth by gently rubbing to clean. Never use window cleaners or solvents. Periodically hand wash the microfiber cloth separately, using mild soap. Do not use bleach or fabric softener. Rinse thoroughly and air dry before next use.

## Software Updates

### Over-the-Air Software Updates

If equipped, see “Updates” under *Settings*  
 ⇨ 148 for details on software updates.

## Radio

### AM-FM Radio

#### Playing the Radio

From the Home Page, touch the Audio icon to display the now playing screen for the active audio source. Touch the source button such as FM or AM in the left corner to change your source.

#### Finding a Station

##### Seeking a Station

From the AM or FM screen, touch the back or forward buttons to search for the previous or next strong station.

##### Tune

Touch  on the infotainment display to enter the Tune screen. Enter a frequency using the keypad.

Touch the  to save the station as a favorite.

Entering a valid AM or FM frequency will automatically tune to the new station but not close the Tune screen.

Touch the Go button or frequency in the list to begin playing the station. The tune page will close and return to the now playing screen.

### Storing Radio Station Favorites

Saved favorite stations will show at the bottom of the now playing screen.

AM or FM favorites can be stored by pressing and holding a favorite slot.

### Audio Settings

Audio settings vary by region.

From the now playing screen, touch  and the following may display.

#### Sound

- Equalizer
- Fade/Balance
- Sound Mode (if equipped)

#### Bose AudioPilot

If equipped, adjusts the volume based on the noise inside the vehicle and vehicle speed.

#### Manage Radio Favorites

Displays a list of audio favorites that can be moved or deleted.

**Radio Text (RDS)**

When on, radio station call letters and messages from radio stations will be shown.

**Radio Text Category**

When on, category information about current radio content will be shown.

**Radio Data System (RDS)**

RDS relies on receiving specific RDS information from radio stations and only works when the information is available. It is possible that a radio station could broadcast information that causes the radio to work improperly.

In addition, RDS features are region and country of sale specific. This means specific RDS content may not be available in your listening area or in the country you operate the vehicle.

To turn RDS features on or off, see "Audio Settings" previously.

The following RDS features may be supported by radio broadcasters in your listening area:

**RDS features**

- Display radio station call letters
- Display messages from radio stations

- Provide radio station category information (when available)

**Satellite Radio****SiriusXM Radio Service**

If equipped, vehicles with a valid SiriusXM radio subscription can receive SiriusXM programming.

SiriusXM radio has a wide variety of programming and commercial-free music, coast to coast, in digital-quality sound. In the U.S., see [www.siriusxm.com](http://www.siriusxm.com) or call 1-888-601-6296. In Canada, see [www.siriusxm.ca](http://www.siriusxm.ca) or call 1-877-438-9677.

When SiriusXM is active, the channel name, number, song title, and artist appear on the display.

**SiriusXM with 360L**

SiriusXM with 360L interface has enhanced in-vehicle listening experience for subscribers. The experience now offers more categories and system learned recommendations toward discovering more personalized content.

To use the full SiriusXM 360L program, including streaming content and listening recommendations, OnStar Connected Access

is required and Terms and Conditions accepted. Connected vehicle services vary by model and require a complete working electrical system, cell reception, and GPS signal.

Reference the SiriusXM user guide for use and subscription information.

**Playing SXM Content**

Touch ◀, II, ▶ or ▶▶ on the now playing screen to rewind, pause, play, or fast forward content.

**Finding a Channel**

From the SiriusXM now playing screen, touch ◀ CH or CH ▶ to open the SXM tuner channel list.

To directly tune to a channel, touch the Tune icon to enter a channel number using the keypad.

**Browsing Content**

Touch  to view different browsing content.

Browse will include Channels, Music, On Demand shows and episodes, Sports and News content.

### SiriusXM Settings

From the SiriusXM now playing screen, touch the user settings icon in the upper right to display the SiriusXM settings

The settings include subscription information, help and support, and listener preferences.

### Radio Reception

Unplug electronic devices from the accessory power outlets if there is interference or static in the radio.

### FM

FM signals only reach about 16 to 65 km (10 to 40 mi). Although the radio has a built-in electronic circuit that automatically works to reduce interference, some static can occur, especially around tall buildings or hills, causing the sound to fade in and out.

### AM

The range for most AM stations is greater than for FM, especially at night. The longer range can cause station frequencies to interfere with each other. Static can also occur when things like storms and power

lines interfere with radio reception. When this happens, try reducing the treble on the radio.

### SiriusXM Satellite Radio Service

If equipped, SiriusXM Satellite Radio Service provides digital radio reception. Tall buildings or hills can interfere with satellite radio signals, causing the sound to fade in and out. In addition, traveling or standing under heavy foliage, bridges, garages, or tunnels may cause loss of the SiriusXM signal for a period of time. Some cellular services may interfere with SXM reception causing loss of signal.

### Mobile Device Usage

Mobile device usage, such as making or receiving calls, charging, or just having the mobile device on may cause static interference in the radio. Unplug the mobile device or turn it off if this happens.

### Multi-Band Antenna

The multi-band roof antenna may be used for radio, navigation, and other communication systems, depending on the equipped options. To ensure clear reception, keep the antenna clear of obstructions, such

as snow and ice. If the vehicle has a sunroof, and it is open, or a roof loaded with cargo, reception may be affected.

## Audio Players

### Avoiding Untrusted Media Devices

When using media devices such as USB and mobile devices, consider the source. Untrusted media devices could contain files that affect system operation or performance and should be avoided.

### USB Port

The vehicle may be equipped with multiple USB ports. Ports may also be used for charging. Music may be played from a connected USB device.

Caution
To avoid vehicle damage, unplug all accessories and disconnect all accessory cables from the vehicle when not in use. Accessory cables left plugged into the vehicle, unconnected to a device, could be damaged or cause an electrical short if (Continued)

**Caution (Continued)**

the unconnected end comes in contact with liquids or another power source such as the accessory power outlet.

**USB Audio**

To play music via USB:

1. On the audio now playing page, touch source and select USB.
2. If there is no device connected, follow the screen prompts to connect the device.
3. Supported media content will appear on the display.

**Bluetooth Audio**

Music may be played from a connected Bluetooth device.

Volume and song selection may be controlled by using the infotainment controls. If Bluetooth is selected and no volume is present, check the volume setting on the infotainment system.

To play music via Bluetooth:

1. On the audio now playing page, touch source and select the desired Bluetooth device.
2. If there is no device connected, follow the screen prompts to pair the device.
3. Supported media content will appear on the display.

**Manage Bluetooth Devices**

Managing Bluetooth devices allows you to add, delete, or select another paired device.

Only one Bluetooth device can be active at a time.

Some smartphones support sending Bluetooth music information to display on the radio. When the radio receives this information, it will check to see if any is available and display it. For more information about supported Bluetooth features, visit your brand website. See *Online Account* ⇨ 368 for details.

See *Radio Frequency Statement* ⇨ 374.

**Navigation****Using the Navigation System**

The Navigation software is provided by Google Maps. The information provided in this section is a general overview and is subject to change. For the latest functional information, see [g.co/mapsincarc](http://g.co/mapsincarc).

Accept the Terms and Conditions to use.

**Internet Connectivity**

Google Maps relies on a subscription data plan for full functionality, including availability of offline maps. With an applicable connected services plan, Google Maps can be used offline when driving through connectivity dead zones by auto-downloading offline maps prior to going offline.

**Profiles**

Sign in to a Google Account for personalized service. Information available in the Google Account will be shown.

To log into a profile, see *Accounts under Settings* ⇨ 148.

**Voice Assistant**

If equipped, Google Maps can be controlled by voice commands, see Google Assistant under *Voice Recognition* ⇨ 141.

**Language and Units**

To change the language, see *Settings* ⇨ 148.

To change the units, see *Instrument Cluster* ⇨ 94.

**Mute Settings**

During active route guidance, Google Maps can give audible voice directions, traffic alerts, or can be muted. In the Google Maps app, touch Settings, then Mute settings to access the options. Alternatively, audible voice directions and traffic alerts can be muted by tapping sound icon on the turn card during active navigation.

**Compass**

The Google Maps orientation can be changed between the direction currently traveling and pointing north. Touch the compass to switch between these options.

To recenter the map to the current location, touch the location icon.

**Super Cruise**

If equipped, Super Cruise highlights routes in a specific outline. See *Super Cruise* ⇨ 213.

**Electric Vehicle (EV) Features with Google Maps**

When vehicle data is shared with Google, some of the Maps features for EVs are as follows:

- Estimated battery charge level at arrival
- Estimated minimum charging time in order to reach destination

If the vehicle needs to be charged to reach a destination, charging stations may automatically be added to a route.

**Maps****Auto-downloaded Maps**

Google Maps downloads offline maps automatically for use when not connected to the Internet and for making map data available to vehicle features regardless of connectivity. These offline maps are only available when the vehicle has a subscription data plan.

To turn on auto-download:

1. Open Google Maps.

2. Touch Settings.
3. Touch Privacy Center, then select Offline maps.
4. Select Auto-download offline maps.
5. Check the Internet connection and wait for the download to finish.

**Downloading Offline Maps**

1. Open Google Maps.
2. Touch Settings, then Offline maps.
3. Touch the square with the Select your own map icon.
4. Adjust the map to cover the desired area to download.
5. Touch Download.

**Navigation Symbols**

The following are the most common symbols that may appear in Google Maps.



This indicates the vehicle's current location and direction on the map.



The destination pin marks the location of the final destination. Touch the pin to view the destination address or to add it or remove it from the Favorites list. Hide the information by touching the pin one more time. It will automatically time out if no action is taken.

A second pin in the menu is the route overview. Touch this pin to show more details of the destination or to remove the destination.

## Destination

### Searching for a Destination

A destination can be searched using Google Assistant.

To search for a destination without Google Assistant:

1. Open Google Maps.
2. Touch the Search field.
3. Enter the destination.

4. Touch Start.

### Alternate Routes

Alternate routes are displayed as separate lines. While in either turn-by-turn navigation or on the route overview, touch the suggested alternate route.

### Adding a Stop on Route by Voice

1. While in turn-by-turn navigation, touch the Search icon at the bottom.
2. Touch the Google Assistant mic icon and say the destination to search by voice.
3. Select the desired search result from the list.
4. Touch Add stop.

### Adding a Stop on Route by Category

1. While in turn-by-turn navigation, touch the Search icon at the bottom.
2. Select a category.
3. Select the desired search result from the list.
4. Touch Add stop.

### Adding a Home or Work Address

To edit a home or work address, an account must be logged in. See Accounts under *Settings* ⇨ 148.

1. Open Google Maps.
2. Touch Settings and then touch Edit home or work.
3. Enter the address.

### Search by Category

Destinations can be searched by category, such as restaurant or grocery store.

1. Open Google Maps.
2. Touch the search bar.
3. Touch Categories, then select a category.
4. Touch the desired location, then touch Start.

### Avoid Tolls, Highways, or Ferries

1. Open Google Maps.
2. Touch Settings.
3. Select Route options.
4. Select the desired options and then touch close.

### An Alternative Way for General Route Options

1. During active route guidance, touch Route Overview.
2. Select Route options.
3. Select the desired option and then touch close.



**Traffic Layers**

1. Open Google Maps.
2. Touch Settings.
3. Toggle between Traffic on or off.

**Global Positioning System (GPS)**

The current position of the vehicle is determined by using satellite signals and various vehicle signals.

At times, other interference such as the satellite condition, road configuration, condition of the vehicle, and/or other circumstances can affect the navigation system's ability to determine the accurate position of the vehicle.

This system might not be available or interference can occur if any of the following are true:

- Signals are obstructed by tall buildings, trees, large trucks, or a tunnel.
- Satellites are being repaired or improved.

For more information if the GPS is not functioning properly, see *Problems with Route Guidance* ⇨ 140.

**Vehicle Positioning**

At times, the position of the vehicle on the map could be inaccurate due to one or more of the following reasons:

- The road system has changed.
- The vehicle is driving on slippery road surfaces such as sand, gravel, or snow.
- The vehicle is traveling on winding roads or long, straight roads.
- The vehicle is approaching a tall building or a large vehicle.
- The surface streets run parallel to a freeway.
- The vehicle has been transferred by a vehicle carrier or a ferry.
- The current position calibration is set incorrectly.
- The vehicle is traveling at high speed.
- The vehicle changes directions more than once, or the vehicle is turning on a turn table in a parking lot.
- The vehicle is entering and/or exiting a parking lot, garage, or a lot with a roof.
- The GPS signal is not received.
- A roof carrier is installed on the vehicle.
- Tire chains are installed on the vehicle.
- The tires are replaced or worn.

- The tire pressure for the tires is incorrect.
- This is the first navigation use after the map data is updated.
- The 12-volt battery has been disconnected for several days.
- The vehicle is driving in heavy traffic where driving is at low speeds, and the vehicle is stopped and started repeatedly.

**Problems with Route Guidance**

Inappropriate route guidance can occur under one or more of the following conditions:

- The turn was not made on the road indicated.
- Route guidance might not be available when using automatic rerouting for the next right or left turn.
- The route might not be changed when using automatic rerouting.
- There is no route guidance when turning at an intersection.
- Automatic rerouting might display a route returning to the set waypoint if heading for a destination without passing through a set waypoint.

- The route prohibits the entry of a vehicle due to a regulation by time or season or any other regulation which may be given.
- Some routes might not be searched.
- The route to the destination might not be shown if there are new roads, if roads have recently changed, or if certain roads are not listed in Maps.

To recalibrate the vehicle's position on the map, park with the vehicle running for two to five minutes, until the vehicle position updates. Make sure the vehicle is parked in a location that is safe and has a clear view of the sky and away from large obstructions.



## Voice Recognition

If equipped, Google Assistant allows for hands-free use of media and messaging, navigation and climate control functionality in the vehicle. This feature can be started by pressing  on the steering wheel, touching Google Assistant on the Home screen, or by using the wake up words "Hey Google" or "OK Google."

However, not all features within these areas are supported by voice commands and requires the user to have a valid data subscription plan in order to use some of the Google Assistant features.

### Using Voice Recognition

Voice recognition becomes available once the system is initialized. This begins when the vehicle is turned on. Initialization may take a few moments.

1. Press  on the steering wheel controls, touch Google Assistant on the Home screen, or use the wake up words "Hey Google" or "OK Google" to activate voice recognition. Google Assistant must be set as the Default Assistant for the  and the wake word options to work.
2. Clearly speak one of the commands described later in this section.

### Canceling Google Assistant

- Press  on the steering wheel controls to cancel the Google Assistant request.

### Helpful Hints for Speaking Commands

Voice recognition identifies commands that are naturally stated in sentence form, or direct commands that state the application and the task.

For best results:

- Speak the command naturally, not too fast, not too slow.
- Use direct commands without a lot of extra words. For example, "Call <name> at work," "Play" followed by the artist or song name, or "Play" followed by the radio station number.

Direct commands are more clearly understood by the system. An example of a direct command is "Call <number>."

If a cell phone number was saved with a name and a place, the direct command should include both. For example "Call <name> at work."

### Voice Recognition for the Radio

When voice is started, the voice recognition commands for AM, FM, SiriusXM (if equipped), and media apps (if supported) are available.

**“Play <AM frequency> AM”** : Tune to the radio station frequency identified in the command (like “nine fifty”).

**“Play <FM frequency> FM”** : Tune to the radio station frequency identified in the command (like “one oh one point one”).

**“Play channel <SXM channel number> on SiriusXM”** : Tune to the SiriusXM radio station channel number identified in the command. This command may require an online connection.

**“Play <SXM channel name> on Sirius XM”** : Tune to the SiriusXM radio station channel name identified in the command. This command may require an online connection.

**“Play <Media> on <Audio Source>”** : Play media like a song or channel using a specified audio source such as Pandora or Spotify. This command may require an online connection.

### Voice Recognition for the Phone

Make sure the phone is paired using Bluetooth to use the phone related voice commands.

**“Call <contact name>”** : Initiate a call to a stored contact. The command may include location if the contact has location numbers

stored. You must accept Personal Results permission during set up for access to the contacts.

**“Call < phone number>”** : Initiate a call to a phone number of seven digits or 10 digits.

**“Send a message to <contact name>”** : Send a message to a stored contact.

### Voice Recognition for Navigation

Navigation commands can be used to start, cancel route, or add way points/POI.

**“Navigate to <destination address>”** : Initiate navigation to the address in the command.

**“Find a <Place of Interest>”** : Find and initiate navigation to a POI in the command.

**“Add <destination> on my way”** : Adds a way-point to the current route.

**“Take me home”** : Starts navigation to Home location set in Google maps.

### Onboard Vehicle Commands

These commands can be used to adjust vehicle temperature, control window defrosters, etc.

**“Turn on the A/C”** : Turns on the air conditioning.

**“Set temperature to <desired number> degrees”** : Set to a specific temperature inside your vehicle.

### Phone Assistant Voice Recognition

While a device is connected via Bluetooth, Android Auto, or CarPlay, press and hold  on the steering wheel controls to pass through and launch the Voice Assistant on the connected mobile phone (e.g, Google assistant, Siri, etc.).

## Phone

### Bluetooth (Overview)

The Bluetooth-capable system can interact with many mobile devices to:

- Place and receive calls in a hands-free mode.
- Share the device’s address book or contact list with the vehicle.
- Stream audio (music, podcasts).
- Notify receipt of text messages.

To minimize driver distraction, before driving, and with the vehicle parked:

- Become familiar with the features of the mobile device. Organize the phone book and contact lists clearly and delete duplicate or rarely used entries.
- Review the controls and operation of the infotainment system.
- Pair mobile device(s) to the vehicle. The system may not work with all mobile devices. See “Pairing” later in this section.

Vehicles with a Bluetooth system can use a Bluetooth-capable mobile device with a Hands-Free Profile to make and receive phone calls. The infotainment system and voice recognition are used to control the system. The system can be used while the vehicle is on or in accessory mode. The range of the Bluetooth system can be up to 9.1 m (30 ft). Not all mobile devices support all functions and not all mobile devices work with the Bluetooth system. See *Online Account* ⇨ 368 for more information about compatible mobile devices.

## Controls

Use the controls on the infotainment display and the steering wheel to operate the Bluetooth system.

## Steering Wheel Controls

 : Press and release to answer incoming calls on your connected Bluetooth mobile device. Press and hold for mobile device assistant.

 : Press to end a call, decline a call, or cancel an operation. Press to mute or unmute the infotainment system when not on a call.

## Infotainment System Controls

For information about how to navigate the menu system using the infotainment controls, see *Using the System* ⇨ 131.

## Audio System

When using the Bluetooth mobile device system, sound comes through the vehicle's front audio system speakers and overrides the audio system. The volume level while on a mobile device call can be adjusted by pressing the steering wheel controls or the volume controls for the infotainment system. The adjusted volume level remains in memory for later calls. The volume cannot be lowered beyond a certain level.

## Bluetooth (Pairing and Using a Phone)

### Pairing

A Bluetooth-enabled mobile device must be paired to the Bluetooth system and then connected to the vehicle before it can be used. See the mobile device manufacturer's user guide for Bluetooth functions before pairing the device.

### Pairing Information

- Touch the Phone icon on the home page of the infotainment display.
- If no mobile device has been paired, a message on the infotainment display will show the Manage Phones option. Touch this option and the Phones screen will display. See “Pairing a Phone” later in this section.
- A Bluetooth smartphone with music capability can be paired to the vehicle as a smartphone and a music player at the same time.
- Up to 10 devices can be paired to the Bluetooth system.
- The pairing process is disabled when the vehicle is moving.

- Pairing only needs to be completed once, unless the pairing information on the cell phone changes or the cell phone is deleted from the system.
- If multiple paired cell phones are within range of the system, the system connects to the paired cell phone that is set to First to Connect. If there is no cell phone set to First to Connect, it will link to the cell phone which was used last. To link to a different paired cell phone, see "Linking to a Different Phone" later in this section.

**Pairing a Phone**

1. Make sure Bluetooth has been enabled on the cell phone before starting the pairing process.
2. Touch the Phone icon on the Home Page.
3. If no mobile device is connected, touch Manage Phones and the Phones screen will display.

If another mobile device is connected already, touch Settings, Connections, and then Phones.

4. Touch Add Phone.

If a previously added phone is disconnected, the "Add Phone" card will just be a "+" card.

5. Follow the on-screen prompts to pair the cell phone.
6. Follow the instructions on the cell phone to confirm the six-digit code showing on the infotainment display and touch Pair. The code on the cell phone and infotainment display needs to be acknowledged for a successful pair.
7. Start the pairing process on the cell phone to be paired to the vehicle. See the cell phone manufacturer's user guide for information on this process. Once the cell phone is paired, it will show as Connected.
8. If the vehicle name does not appear on your cell phone, there are a few ways to start the pairing process over:
  - Make sure there is not an entry for the vehicle under the previously connected list. If the vehicle and cell phone were previously paired and one still remembers the other, it will not identify as a new device when searching.
  - Turn the Bluetooth off and on the device.
9. If the cell phone prompts to accept connection or allow phone book download, touch Always Accept and Allow. The phone book may not be available if not accepted.
10. To pair additional cell phones, touch Settings, Connections, and then Phones.

**First to Connect Paired Phones**

If multiple paired cell phones are within range of the system, the system connects to the paired cell phone that is set as First to Connect. To enable a paired cell phone as the First to Connect phone:

1. Make sure the cell phone is turned on.
2. Touch the Settings icon on the home page.
3. Touch Connections.
4. Touch Phone.

5. Touch Options under the connected phone.
6. Touch First to Connect from the cell phone's settings menu. The settings will be enabled for that device.

Cell phones and mobile devices can be added, removed, connected, and disconnected. A sub-menu will display whenever a request is made to add or manage cell phones and mobile devices.

### Accessing the Device List Screen

There are two ways to access the device list screen:

#### Using the Settings Icon

1. Touch the Settings icon on the Home Page or the Settings icon on the shortcut tray near the left of the display.
2. Touch Connections.
3. Touch Phones.

#### Using the Phone Icon

1. Touch the Phone icon on the Home Page or the Phone icon on the shortcut tray near the left of the display.
2. Touch  on the top right of the Phones screen.
3. Touch Connected Phone.

### Disconnecting a Connected Phone

To disconnect a phone:

1. Open the Device List Screen. See "Accessing the Device List Screen" previously in this section.
2. Touch Option on the phone card to show the cell phone's or mobile device's settings.
3. Touch Disconnect.

### Deleting a Paired Phone

To delete a paired phone:

1. Open the Device List Screen. See "Accessing the Device List Screen" previously in this section.
2. Touch Option on the phone card to show the cell phone's or mobile device's settings.
3. Touch Forget Phone.

### Linking to a Different Phone

To link to a different cell phone, the new cell phone must be in the vehicle and paired to the Bluetooth system.

To link to a different phone:

1. Open the Device List Screen. See "Accessing the Device List Screen" previously in this section.

2. Touch the new cell phone to link to from the list of available phones. See "First to Connect Paired Phones" previously in this section.

### Switching to Handset or Hands-Free Mode

To switch between handset or hands-free mode:

- While the active call is hands-free, touch the Audio Output option, then touch Phone to switch to the handset mode. The mute icon will not be available or functional while Handset mode is active.
- While the active call is on the handset, touch the Audio Output option, then touch Car Speakers to switch to the hands-free mode.

### Making a Call Using Contacts

Calls can be made through the Bluetooth system using personal cell phone contact information for all cell phones that support the Phone Book feature. Become familiar with the cell phone settings and operation and that the phone is set to allow the sharing of contacts over Bluetooth with the vehicle. Verify the cell phone supports this

feature and that the phone is set to allow the sharing of contacts over Bluetooth with the vehicle..

The Contacts menu accesses the phone book stored in the cell phone.

To make a call using the Contacts menu:

1. Touch the Phone icon on the Home Page or on the shortcut tray near the left of the display.
2. Touch Contacts.
3. There are two methods to search for contacts:
  - Search bar – Touch the search icon on the top right of the Phones window and type the name or number of the contact on the keyboard. Search results will be displayed corresponding to the user input. Touch the name to call.
  - Scroll – Touch the list and scroll, or use the scrollbar on the left side of the Phones window. Touch the name to call.

### **Making a Call Using the Recents Menu**

The Recents menu accesses the recents call list from your cell phone.

To make a call using the Recents menu:

1. Touch the Phone icon on the Home Page or on the shortcut tray near the left of the display.
2. Touch Recents.
3. Touch the name or number to call.

### **Making a Call Using the Keypad**

To make a call by dialing the numbers:

1. Touch the Phone icon on the Home Page or on the shortcut tray near the left of the display.
2. Touch Keypad and enter a phone number.
3. Touch the phone icon on the infotainment display to start dialing the number.

### **Searching Contacts Using the Keypad**

To search for contacts using the keypad:

1. Touch the Phone icon on the Home Page.
2. Touch Keypad and enter partial phone numbers or contact names using the digits on the keypad to search.

Results appear on the right side of the display. Touch one to place a call.

### **Accepting or Declining a Call**

When an incoming call is received, the infotainment system mutes and a ring tone is heard in the vehicle.

#### **Accepting a Call**

There are two ways to accept a call:

- Press  on the steering wheel controls.
- Touch Answer on the infotainment display.

#### **Declining a Call**

There are two ways to decline a call:

- Press  on the steering wheel controls.
- Touch Decline on the infotainment display.

### **Call Waiting**

Call waiting must be supported on the Bluetooth cell phone and enabled by the wireless service carrier to work.

#### **Accepting a Call**

Press  to answer, then touch Switch on the infotainment display.



#### **Declining a Call**

Press  to decline, then touch Decline on the infotainment display.

### Switching Between Calls (Call Waiting Calls Only)

To switch between calls, touch Phone on the Home Page to display Call View. While in Call View, touch the call information of the call on hold to change calls.

### Ending a Call

- Press  on the steering wheel controls.
- Touch  on the infotainment display, next to a call, to end only that call.

### Dual Tone Multi-Frequency (DTMF) Tones

The in-vehicle Bluetooth system can send numbers during a call. This is used when calling a menu-driven phone system. Use the Keypad to enter the number.

### Apple CarPlay and Android Auto

If equipped, Android Auto and/or Apple CarPlay capability may be available through a compatible smartphone. If available and connected, the Android Auto and Apple CarPlay icons will change from gray to white on the Home Page of the infotainment display.

To use Android Auto and/or Apple CarPlay:

#### For Wired Phone Projection

1. Download the Android Auto app to your smartphone from Google Play for phones running Android 9 and below. There is no app required for Apple CarPlay or newer versions of Android.
2. Connect your Android phone or Apple iPhone by using the factory-provided phone USB cable and plugging into a front USB data port. For best performance, it is highly recommended to use the device's factory-provided USB cable, which should be replaced after significant wear to maintain connection quality. Aftermarket or third-party cables may not work.
3. When the phone is first connected to activate Apple CarPlay or Android Auto, the "Terms and Conditions" consent will appear.
  - Touch Enable to launch Apple CarPlay or Android Auto.
  - Touch Disable to remove Apple CarPlay and Android Auto capability from the vehicle Settings menu. Other functions may still work.

#### For Wireless Phone Projection

1. Download the Android Auto app to your smartphone from Google Play for phones running Android 9 and below. There is no app required for Apple CarPlay or newer versions of Android.
2. For first time connection:
  - Connect the phone over Bluetooth. See *Bluetooth (Pairing and Using a Phone)* ⇨ 143 or *Bluetooth (Overview)* ⇨ 142.
3. Make sure Wi-Fi and Bluetooth is turned on the phone for wireless projection to work.
4. When the phone is first connected to activate Apple CarPlay or Android Auto, agree to the terms and conditions on the infotainment system. Touch Enable to launch Apple CarPlay or Android Auto.
5. Follow the instructions on the phone.

The Android Auto and Apple CarPlay icons on the Home Page will illuminate depending on the smartphone. Android Auto and/or Apple CarPlay may automatically launch. If not, touch the Android Auto or Apple CarPlay icon on the Home Page to launch.





To disconnect the phones wireless projection:

1. Select Settings from the Home Page.
2. Select Connections.
3. Select Phones.
4. Touch Options on the phone card.
5. Turn off Apple CarPlay or Android Auto.

Press  on the center stack to return to the Home Page.

Features are subject to change. For further information on how to set up Android Auto and Apple CarPlay in the vehicle, see your vehicles brand website.

Android Auto is provided by Google and is subject to Google's terms and privacy policy. Apple CarPlay is provided by Apple and is subject to Apple's terms and privacy policy. Data plan rates apply. For Android Auto support see <https://support.google.com/androidauto>. For Apple CarPlay support see [www.apple.com/ios/carplay/](http://www.apple.com/ios/carplay/). Apple or Google may change or suspend availability at any time. Google, Android, Android Auto, Google Maps and other marks are trademarks of Google LLC. Apple CarPlay is a trademark of Apple Inc.

Press  on the center stack to exit Android Auto or Apple CarPlay. To enter back into Android Auto or Apple CarPlay, press and hold  on the center stack.

Apple CarPlay and Android Auto can be disabled from the infotainment system. To do this, touch Home>Settings>Connections>Phones and then Phone Options on the phone card. Use the On/Off toggled to turn off Apple CarPlay or Android Auto for that phone.

## Settings

To access the personalization menus:

1. Touch Settings on the Home Page on the infotainment display.
2. Touch the desired category to display a list of available options.
3. Touch to select the desired feature setting.
4. Touch the options on the infotainment display to disable or enable a feature.
5. Touch  to go back.

The Settings menu may contain the following:

### Connections

The menu may contain the following:

#### Phones

Allows connecting to a different cell phone or mobile device source, disconnect a cell phone or media device, or delete a cell phone or media device.

#### Wi-Fi Networks

Shows connected and available Wi-Fi networks.

#### Wi-Fi Hotspot

Allows adjustment of different Wi-Fi features.

#### Trusted Device

Allows for setting a phone as your trusted device to establish a secure communication channel between your phone and vehicle that enables convenient features like instant profile unlocking and account sign in. When nearby, your trusted device is recognized automatically via a unique Bluetooth connection. Requires the MyGMC mobile app.

**Vehicle-to-Phone Sharing****Vehicle**

The menu may contain the following:

**One-Pedal Driving**

When on, the vehicle will slow/stop when the accelerator is let off. High slows the vehicle with more force. See *One-Pedal Driving* ⇨ 187.

**Teen Driver**

See “Teen Driver” under *Settings* ⇨ 148.

**Rear Seat Reminder**

Allows for a chime and a message when the rear door has been opened before or during operation of the vehicle.

**Buckle to Drive**

This feature can prevent shifting out of Park when the driver, and if applicable the front passenger, seat belt is not buckled. See *Buckle To Drive* ⇨ 47.

**Super Cruise Lane Change**

This setting specifies when the vehicle can change lanes while Super Cruise is active. See *Super Cruise* ⇨ 213

**Drive Mode Customization**

See *Driver Mode Control* ⇨ 194.

**Climate and Air Quality**

Adjusts different climate settings.

**Collision/Detection Systems**

Adjusts different driver assistance system settings.

**Comfort and Convenience**

Adjusts different comfort and convenience settings.

**Lighting**

Adjusts different lighting settings.

**Power Door Locks**

Adjusts different door lock settings.

**Remote Lock, Unlock, and Start**

Adjusts different remote lock settings.

**Ride Height**

Adjusts different ride height settings.

**Seating Position**

Adjusts different seating position settings.

**Suspension**

Adjusts different suspension settings.

**Trailer**

Adjusts different trailering settings.

**Apps & Permissions**

Shows a list of installed apps and the permissions used.

**Date / Time**

Allows setting of the clock.

**Display**

Allows adjustment of the infotainment display.

**Sounds**

Allows adjustment of the infotainment system sounds.

**Users**

Modifies the infotainment system’s users.

**Accounts**

Allows adding or adjusting of the user accounts.

**Privacy**

Allows adjustment of the privacy settings.

### Storage

This menu shows the storage info on the infotainment system.

### Security

This menu allows adjustment of the infotainment security settings.

### System

The menu may contain the following:

#### Language

This will set the display language used on the infotainment display.

#### Keyboard & speech

Touch to change keyboard and speech settings.

#### Reset Options

Touch to change reset settings.

#### TTY Mode

When on, OnStar calls are made as a series of text exchanges. A keyboard is shown for text entry and the phone audio is muted. This feature can be turned off or on.

### About

Touch to view the infotainment system software information.

### Legal Information

Touch to view legal and license information.

### Updates

This menu allows adjustment of the vehicle update settings.

### Google

This menu allows adjustment of the Google settings.

### Teen Driver

If equipped, this allows multiple keys to be registered for beginner drivers to encourage safe driving habits. When the vehicle is started with a Teen Driver key, it will automatically activate certain safety systems, allow setting of some features, and limit the use of others. The Report Card will record vehicle data about driving behavior that can be viewed later. When the vehicle is started with a Teen Driver key, the Driver Information Center (DIC) displays a message that Teen Driver is active.

### To access:

1. Touch Settings on the Home Page, then touch Vehicle, and then Teen Driver.
2. Create a Personal Identification Number (PIN) by choosing a four-digit PIN. Re-enter the PIN to confirm. To change the PIN, touch Change PIN.

### The PIN is required to:

- Set up/Add or remove keys.
- Change Teen Driver settings.
- Change or clear the Teen Driver PIN.
- Access or delete Report Card data.

### Set up/Add keys to activate Teen Driver and assign restrictions to the key:

Any vehicle key can be registered, up to a maximum of eight keys. Label the Teen Driver key to tell it apart from the other keys.

### For a pushbutton start system:

1. Start the vehicle.
2. The vehicle must be in P (Park).
3. From the Settings menu, touch Vehicle and then Teen Driver.
4. Enter the PIN.

5. Place the remote key you wish to register in the transmitter pocket. The key does not need to be the one that started the vehicle. See *Remote Key Operation* ⇨ 7 for transmitter pocket location.
6. From the Teen Driver menu, touch Setup Keys or Add/Remove Teen Driver Keys.
  - If the remote key has not previously been registered, the option to add the key displays. Touch Add and a confirmation message displays. Teen Driver restrictions will be applied whenever this remote key is used to operate the vehicle.
  - If the remote key has already been registered, the option to remove the key displays. If Remove is touched, the remote key is no longer registered. A confirmation message displays, and Teen Driver restrictions will not be applied if this remote key is used to operate the vehicle.

In vehicles with a pushbutton start system, if a Teen Driver and a non-Teen Driver key are both present at start up, the vehicle will recognize the non-Teen Driver key to start the vehicle. The Teen Driver settings will not be active.

### Manage Settings or Teen Driver Settings

Depending on the options of your vehicle, the following menu items may be displayed:

**Buckle to Drive** : When turned ON, Buckle to Drive prevents the driver from shifting out of P (Park) for a period of time after the brake pedal is pressed if the driver, or on some vehicles the detected passenger, has not buckled their seat belt. On some vehicles, Buckle to Drive is always ON when Teen Driver is active and is not configurable. See *Buckle To Drive* ⇨ 47.

**Audio Volume Limit** : Allows a maximum audio volume to be set. Turn the audio volume limit on or off. Use the arrows to choose the maximum allowable level for the audio volume. On some infotainment systems, touch Set Audio Volume Limit to choose the maximum allowable audio volume level.

**Set Audio Volume Limit** : Use the arrows to choose the maximum allowable level for the audio volume.

**Teen Driver Speed Limiter** : Limits the maximum speed of the vehicle. When the speed limiter is turned on and the vehicle is

started with a Teen Driver key, the DIC displays a message that the top speed is limited.

On certain vehicles, when the Speed Limiter is turned ON, the vehicle's maximum acceleration will be limited. The DIC will display a message that the acceleration is limited.

**Teen Driver Speed Warning** : Displays a warning in the DIC when exceeding a selectable speed. Turn the speed warning on or off and choose the desired speed warning level. The speed warning does not limit the speed of the vehicle. On some infotainment systems, touch Set Teen Driver Speed Warning to set the warning speed.

**Set Teen Driver Speed Warning** : Choose the desired speed warning level. The speed warning does not limit the speed of the vehicle.

**SiriusXM Explicit Content Filter** : Allows the SiriusXM Explicit Content Filter to be turned ON or OFF. When ON, the teen driver will not be able to listen to SiriusXM stations that contain explicit content, and the Explicit Content Filter selection in the Audio Settings will be unavailable for change.

**When Teen Driver is Active:**

- If equipped, the radio will mute when the driver seat belt, and in some vehicles the front passenger seat belt, is not buckled. The audio from any device paired to the vehicle will also be muted.
- An object placed on the front passenger seat, such as a briefcase, handbag, grocery bag, laptop, or other electronic device, could cause the passenger sensing system to falsely sense an unbuckled front passenger and mute the radio. If this happens, remove the object from the seat. See *Passenger Sensing System* ⇨ 57.
- Some safety systems, such as Automatic Emergency Braking, if equipped, cannot be turned off.
- The gap setting for Adaptive Cruise Control and alert timing for Forward Collision Alert, if equipped, cannot be changed.
- When trying to change a safety feature that is not configurable in Teen Driver, the feature may be grayed out or removed from the infotainment menu, or the DIC will display a message indicating that Teen Driver is active and the action is not available.

- Super Cruise, if equipped, is not available.
- Do not tow a trailer if equipped with Automatic Emergency Braking.

**Report Card**

The vehicle owner must secure the driver's consent to record certain vehicle data when the vehicle is driven with a registered Teen Driver key. There is one Report Card per vehicle. Data is only recorded when a registered Teen Driver key is used to operate the vehicle.

The Report Card data is collected from the time Teen Driver is activated or the last time the Report Card was reset. The following items may be recorded:

- Distance Driven – the total distance driven.
- Maximum Speed – the maximum vehicle speed detected.
- Overspeed Warnings – the number of times the speed warning setting was exceeded.
- Wide Open Throttle – the number of times the accelerator pedal was pressed nearly all the way down.

- Forward Collision Alerts (if equipped) – the number of times the driver was notified when approaching a vehicle ahead too quickly and at potential risk for a crash.
- Forward Automatic Braking, also called Automatic Emergency Braking (if equipped) – the number of times the vehicle detected that a forward collision was imminent and applied the brakes.
- Reverse Automatic Braking (if equipped) – the number of times the vehicle detected that a rearward collision was imminent and applied the brakes.
- Traction Control – the number of times the Traction Control System activated to reduce wheel spin or loss of traction.
- Stability Control – the number of events which required the use of electronic stability control.
- Antilock Braking System Active – The number of Antilock Brake System activations.
- Tailgating Alerts (if equipped) – the number of times the driver was alerted for following a vehicle ahead too closely.

### Report Card Data

Cumulative Data is saved for all trips until the Report Card is reset or until the maximum count is exceeded. If the maximum count is exceeded for a Report Card line item, that item will no longer be updated in the Report Card until it is reset. Each item will report a maximum of 1,000 counts. The distance driven will report a maximum of 64,374 km (40,000 mi).

To delete Report Card data, do one of the following:

- From the Report Card display, touch Reset.
- Touch Clear PIN and All Teen Driver Keys from the Teen Driver menu. This will also unregister any Teen Driver keys and delete the PIN.

### Forgotten PIN

See your dealer to reset the PIN.

## Trademarks and License Agreements

### FCC Information

See *Radio Frequency Statement* ⇨ 374.



"Made for iPhone," means that an electronic accessory has been designed to connect specifically to iPhone, and has been certified by the developer to meet Apple performance standards. Apple is not responsible for the operation of this device or its compliance with safety and regulatory standards. Please note that the use of this accessory with iPhone may affect wireless performance. iPhone are trademarks of Apple Inc., registered in the U.S. and other countries.



Trial length and service availability may vary by model, model year or trim. Service will automatically stop at the end of your trial subscription period unless you decide to

continue service. If you do not wish to enjoy your trial, you can cancel by calling the number below. All SiriusXM services require a subscription, each sold separately by SiriusXM after the trial period. Service subject to the applicable SiriusXM Customer Agreement and Privacy Policy, visit [www.siriusxm.com](http://www.siriusxm.com) (USA) or [www.siriusxm.ca](http://www.siriusxm.ca) (Canada) to see complete terms and how to cancel which includes calling 1-866-635-2349 (USA) or 1-888-539-7474 (Canada). Some services and features are subject to device capabilities and location availability. Content varies by SiriusXM subscription package. All fees, content and features are subject to change.

SiriusXM with 360L: Some features, including steaming content and listening recommendations, require an active OnStar Connected Access plan and may vary by vehicle model. Content varies by SiriusXM subscription plan. GM connected vehicle services vary by vehicle model and require active service plan, working electrical system, cell reception and GPS signal. See [onstar.com](http://onstar.com) for details and limitations.

SiriusXM, Pandora, Stitcher and all related logos are trademarks of Sirius XM Radio Inc. and its respective subsidiaries.

SiriusXM satellite service is only available in the 48 contiguous United States (and Puerto Rico with limited availability) and Canada.

In Canada: Some deterioration of service may occur in extreme northern latitudes. This is beyond the control of SiriusXM.

Explicit Language Notice: Channels with frequent explicit language are indicated with an “XL” after the channel name.

Family-friendly packages are available by contacting SiriusXM:

- USA Customers — See [www.siriusxm.com](http://www.siriusxm.com) or call 1-888-601-6296.
- Canada Customers — See [www.siriusxm.ca](http://www.siriusxm.ca) or call 1-877-438-9677.

It is prohibited to copy, decompile, disassemble, reverse engineer, hack, manipulate, or otherwise make available any technology or software incorporated in receivers compatible with the SiriusXM Satellite Radio System or that support the SiriusXM website, the Online Service or any of its content.

General Requirements:

1. A License Agreement from SiriusXM is required for any product that incorporates SiriusXM Technology and/or for use of any of the SiriusXM marks to

be manufactured, distributed, or marketed in the SiriusXM Service Area.

2. For products to be distributed, marketed, and/or sold in Canada, a separate agreement is required with Sirius XM Canada Inc.



immersion.

TouchSense Technology and TouchSense System 1000 Series Licensed from Immersion Corporation. TouchSense System 1000 is protected under one or more of the U.S. Patents at the following address [www.immersion.com/patent-marking.html](http://www.immersion.com/patent-marking.html) and other patents pending.

**Bose**

Bose AudioPilot and Bose Centerpoint surround are registered trademarks of Bose Corporation in the U.S. and other countries.

**Bluetooth**

The Bluetooth word mark and logos are owned by the Bluetooth SIG, Inc. and any use of such marks by General Motors is under license. Other trademarks and trade names are those of their respective owners.

**Java**

Java is a registered trademark of Oracle and/or its affiliates.

**MPEG4–AVC (H.264)**

THIS PRODUCT IS LICENSED UNDER THE AVC PATENT PORTFOLIO LICENSE FOR THE PERSONAL AND NON-COMMERCIAL USE OF A CONSUMER TO (i) ENCODE VIDEO IN COMPLIANCE WITH THE AVC STANDARD (“AVC VIDEO”) AND/OR (ii) DECODE AVC VIDEO THAT WAS ENCODED BY A CONSUMER ENGAGED IN A PERSONAL AND NON-COMMERCIAL ACTIVITY AND/OR WAS OBTAINED FROM A VIDEO PROVIDER LICENSED TO PROVIDE AVC VIDEO. NO LICENSE IS GRANTED OR SHALL BE IMPLIED FOR ANY OTHER USE. ADDITIONAL INFORMATION MAY BE OBTAINED FROM MPEG LA, LLC. SEE [HTTPS://WWW.MPEGLA.COM](https://www.mpegla.com).

**VC-1**

THIS PRODUCT IS LICENSED UNDER THE VC-1 PATENT PORTFOLIO LICENSE FOR THE PERSONAL AND NON-COMMERCIAL USE OF A CONSUMER TO (i) ENCODE VIDEO IN COMPLIANCE WITH THE VC-1 STANDARD ("VC-1 VIDEO") AND/OR (ii) DECODE VC-1 VIDEO THAT WAS ENCODED BY A CONSUMER ENGAGED IN A PERSONAL AND NON-COMMERCIAL ACTIVITY AND/OR WAS OBTAINED FROM A VIDEO PROVIDER LICENSED TO PROVIDE VC-1 VIDEO. NO LICENSE IS GRANTED OR SHALL BE IMPLIED FOR ANY OTHER USE. ADDITIONAL INFORMATION MAY BE OBTAINED FROM MPEG LA, LLC. SEE [HTTPS://WWW.MPEGLA.COM](https://www.mpegla.com).

**MPEG4–Visual**

USE OF THIS PRODUCT IN ANY MANNER THAT COMPLIES WITH THE MPEG-4 VISUAL STANDARD IS PROHIBITED, EXCEPT FOR USE BY A CONSUMER ENGAGING IN PERSONAL AND NON-COMMERCIAL ACTIVITIES.

**MP3**

MPEG Layer-3 audio coding technology licensed from Fraunhofer IIS and Thomson.

**WMV/WMA**

This product includes technology owned by Microsoft Corporation and under a license from Microsoft Licensing, GP. Use or distribution of such technology outside of this product is prohibited without a license from Microsoft Corporation and/or Microsoft Licensing, GP as applicable.



## Climate Controls

### Climate Control Systems

Dual Automatic Climate Control System .....	156
Rear Climate Control System .....	158

### Air Vents

Air Vents .....	159
-----------------	-----

### Maintenance

Passenger Compartment Air Filter .....	160
Service .....	160

## Climate Control Systems

### Dual Automatic Climate Control System

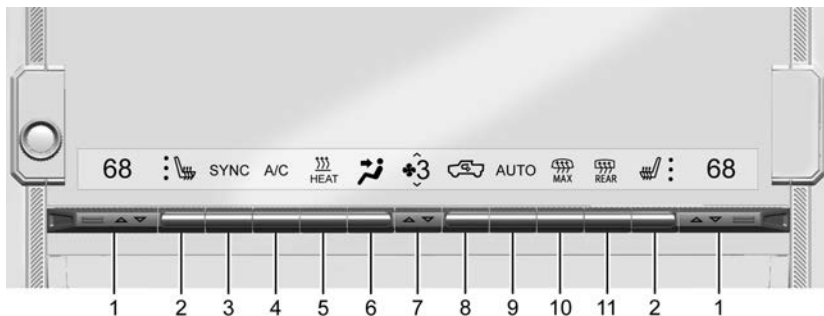

1. Driver and Passenger Temperature Settings
2. Driver and Passenger Heated and Ventilated Seat Launch Buttons
3. SYNC (Synchronized Temperature)
4. A/C (Air Conditioning)
5. HEAT (Heater)
6. Air Delivery Mode Control Launch Button
7. Fan Control
8. Recirculation
9. AUTO (Automatic Operation)
10. MAX Defrost
11. Rear Window Defogger/Heated Outside Mirrors

#### Automatic Operation

The system automatically controls the fan speed, air delivery, air conditioning, and recirculation to heat or cool the vehicle to the desired temperature.

When AUTO is selected, all four functions operate automatically. Each function can also be manually set and the selected

setting is displayed. Functions not manually set will continue to be automatically controlled, even if the AUTO indicator is not lit. When enabled, the climate controls will remain in auto mode through power cycles.

For automatic operation:

1. Touch AUTO.
2. Set the temperature. Allow the system time to stabilize. Adjust the temperature as needed for best comfort.

To improve efficiency and to cool the vehicle faster, recirculation may be automatically selected in warm weather.



### Manual Operation

 : Press up or down to increase or decrease fan speed. Toggle all the way down to turn the fan off. When off is selected, a small amount of air may still come out of the outlets depending on the vehicle's speed. If any buttons are pressed, the climate control system will turn on and operate at the current setting.

Touch AUTO to return to automatic operation.

**Driver and Passenger Temperature Control** : The temperature can be adjusted separately for the driver and passenger.

**SYNC** : Touch to link the passenger temperature setting to the driver setting.



**Air Delivery Mode Control** : Touch to change the direction of the airflow. Any combination of , , or  can be selected.

Changing the mode cancels the automatic operation and the system goes into manual mode. Touch AUTO to return to automatic operation.

 : Air is directed to the windshield, outboard A/C outlets, and side window outlets.

 : Air is directed to the A/C outlets.

 : Air is directed to the floor outlets, with some air directed to the windshield, outboard A/C outlets, and side window outlets.

  **MAX** : Air is directed to the windshield and the fan runs at a higher speed if not already above a medium fan speed. This mode overrides the previous mode selected and clears fog or frost from the windshield quickly. When the control is pressed again, the system returns to the previous mode setting and fan speed.

For best results, clear all snow and ice from the windshield before defrosting.

 : Touch to turn on recirculation. An indicator light comes on. Air is recirculated to quickly cool the interior of the vehicle. It can also be used to help reduce outside air and odors that enter the vehicle.

Avoid using recirculation for long periods of time in cold or damp conditions. Using recirculation in cold or damp conditions can result in window fogging.

**A/C** : Press to turn the air conditioning on or off. An indicator light comes on to show that the air conditioning is enabled. If the fan is turned off, the air conditioner will not run.

 **Heat** : Press to turn the heater on or off. The air conditioning compressor is used to provide heat to the cabin and may run when HEAT is enabled.

### Rear Window Defogger

 **REAR** : If equipped, press to turn the rear window defogger on or off. An indicator light on the button comes on to show that the rear window defogger is on.

The rear window defogger only works when the vehicle is on. The defogger turns off if the vehicle is turned off.

If the vehicle is equipped with heated outside mirrors, they turn on when the rear window defogger button is on and help to clear fog or frost from the surface of the mirror. See *Heated Mirrors* ⇨ 26.

### Caution

Using a razor blade or sharp object to clear the inside rear window can damage the rear window defogger. Repairs would not be covered by the vehicle warranty. Do not clear the inside rear window with sharp objects.

### Remote Start Climate Control Operation :

If equipped with remote start, the climate control system may run when the vehicle is started remotely. If equipped with heated or ventilated seats or a heated steering wheel, these features may come on during a remote start. See *Remote Vehicle Start* ⇨ 12, *Heated and Ventilating Front Seats* ⇨ 43, and *Heated Steering Wheel* ⇨ 87.

### Sensors

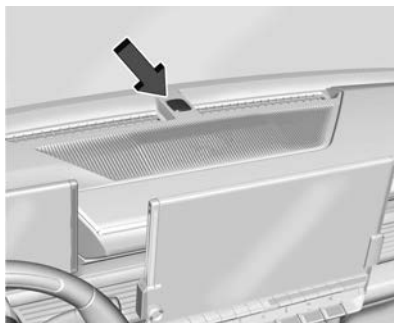

The solar sensor, on top of the instrument panel near the windshield, monitors the solar heat.

The climate control system uses the sensor information to adjust the temperature, fan speed, recirculation, and air delivery mode for best comfort.

Do not cover the sensor; otherwise the automatic climate control system may not work properly.

### Afterblow Feature

If equipped, under certain conditions, the fan may stay on or may turn on and off several times after you turn off and lock the vehicle. This is normal.

### Rear Climate Control System

The rear climate controls are located on the rear of the center console storage.

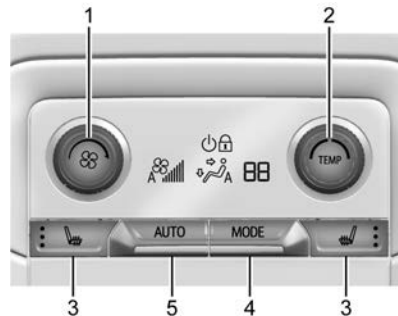

1. Fan Control
2. TEMP (Temperature Control)
3. Heated Rear Seats (If Equipped)
4. MODE (Air Delivery Mode Control)
5. AUTO (Automatic Operation)

If the dual automatic climate control system rear climate control lockout feature is locked, the rear climate control settings can only be adjusted from the front seat.

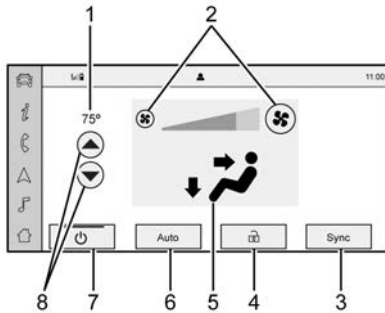

Rear Climate Display

1. Rear Climate Temperature Setting
2. Fan Control
3. Sync (Synchronized Temperatures)
4. Rear Control Lockout
5. Air Delivery Mode Control
6. Auto (Automatic Operation)
7. On/Off (Power)
8. Rear Climate Temperature Control

### Automatic Operation

**AUTO** : Press AUTO to automatically control the fan speed, air delivery, air conditioning, and recirculation to heat or cool the rear seating area to the desired temperature. "A" indicates the automatic operation is active.

If any of the rear climate control settings are manually adjusted, full automatic operation is canceled. Press AUTO to return to full automatic operation.





The display only indicates climate control functions when the system is in rear independent mode.

### Manual Operation

 : Turn clockwise or counterclockwise to increase or decrease the fan speed. Turn completely counterclockwise to turn the fan/power off.

**TEMP** : Turn clockwise or counterclockwise to increase or decrease the airflow temperature into the passenger area. If the SYNC button is pressed on the front climate controls, the rear climate temperature is linked to the driver temperature setting.

**MODE** : Press to change the direction of the airflow in the vehicle. Repeatedly press the button until the desired mode appears on the display. Multiple presses will cycle through the delivery selections.

 or  : If equipped, press  or  to heat the left or right outboard seat cushion. See *Heated Rear Seats* ⇨ 45.

### Air Vents

Use the tab on the air outlets to change the direction of the airflow or shut the outlet.

### Operation Tips

- Clear away any ice, snow, or leaves from the air inlets at the base of the windshield that may block the flow of air into the vehicle.
- Clear snow off the hood to improve visibility and help decrease moisture drawn into the vehicle.
- Use of non-GM approved hood deflectors may adversely affect the performance of the system.
- Keep the areas around the base of the infotainment display and under the seats clear to optimize air circulation.

## Maintenance

### Passenger Compartment Air Filter

The passenger compartment air filter reduces dust, pollen, and other airborne irritants from outside air that is pulled into the vehicle. The filter will need to be replaced periodically. See *Maintenance Schedule* ⇨ 359.

Using the climate control system without an air filter installed is not recommended. Water or other debris could enter the system and result in leaks or noises. Always install a new filter when removing the old filter.

For more information on filter replacement, see your dealer.

### Service

All vehicles have a label underhood that identifies the refrigerant used in the vehicle. The refrigerant system should only be serviced by trained and certified technicians. The air conditioning evaporator should never be repaired or replaced by one from a salvage vehicle. It should only be replaced by a new evaporator to ensure proper and safe operation.

During service, all refrigerants should be reclaimed with proper equipment. Venting refrigerants directly to the atmosphere is harmful to the environment and may also create unsafe conditions based on inhalation, combustion, frostbite, or other health-based concerns.

The air conditioning system requires periodic maintenance. See *Maintenance Schedule* ⇨ 359.

# Driving and Operating

## Driving Information

- Driving for Better Energy Efficiency .... 162
- Distracted Driving ..... 163
- Defensive Driving ..... 164
- Impaired Driving ..... 164
- Control of a Vehicle ..... 164
- Braking ..... 164
- Steering ..... 164
- Off-Road Recovery ..... 165
- Loss of Control ..... 166
- Off-Road Driving ..... 166
- Off-Road App ..... 170
- Driving on Wet Roads ..... 173
- Hill and Mountain Roads ..... 174
- Winter Driving ..... 174
- If the Vehicle Is Stuck ..... 175
- Vehicle Load Limits ..... 176
- Truck-Camper Loading Information .... 179

## Starting and Operating

- New Vehicle Break-In ..... 180
- Power Button ..... 180
- Starting and Stopping the Vehicle .... 181
- Retained Accessory Power (RAP) ..... 182
- Shifting Into Park ..... 182
- Shifting out of Park ..... 183
- Extended Parking ..... 183

## Electric Drive Unit

- Electric Drive Unit ..... 184
- One-Pedal Driving ..... 187

## Drive Systems

- Four-Wheel Drive ..... 188

## Brakes

- Antilock Brake System (ABS) ..... 188
- Electric Parking Brake ..... 189
- Brake Assist ..... 190
- Hill Start Assist (HSA) ..... 190
- Regenerative Braking ..... 190

## Ride Control Systems

- Traction Control/Electronic Stability Control ..... 191
- Acceleration Mode (Watts to Freedom) ..... 193
- Driver Mode Control ..... 194
- Four-Wheel Steering (Including Crabwalk) ..... 196
- Locking Rear Axle ..... 199
- Locking Front Axle ..... 200
- Air Suspension ..... 201

## Cruise Control

- Adaptive Cruise Control (Advanced) ... 203
- Super Cruise ..... 213

## Driver Assistance Systems

- Driver Assistance Systems ..... 227

- Assistance Systems for Parking or Backing ..... 228
- Rear Vision Camera (RVC) ..... 229
- Surround Vision System ..... 229
- Park Assist ..... 237
- Automatic Parking Assist (APA) ..... 238
- Reverse Automatic Braking (RAB) ..... 240
- Rear Pedestrian Alert ..... 242
- Rear Cross Traffic Alert (RCTA) System ..... 242
- Assistance Systems for Driving ..... 243
- Forward Collision Alert (FCA) System ..... 243
- Automatic Emergency Braking (AEB) ..... 245
- Front Pedestrian Braking (FPB) System ..... 246
- Side Blind Zone Alert (SBZA) ..... 248
- Lane Change Alert (LCA) ..... 248
- Lane Keep Assist (LKA) ..... 250

## Charging

- When to Charge ..... 253
- Plug-In Charging ..... 253
- Delayed Charging Override ..... 257
- Charging Status Feedback ..... 257
- Charge Cord ..... 259
- Utility Interruption of Charging ..... 261
- Electrical Requirements for Battery Charging ..... 262

**Trailer Towing**

General Towing Information ..... 262  
 Driving Characteristics and  
 Towing Tips ..... 263  
 Trailer Towing ..... 266  
 Towing Equipment ..... 270  
 Trailer Sway Control (TSC) ..... 278  
 Trailering App ..... 279

**Conversions and Add-Ons**

Add-On Electrical Equipment ..... 288

**Driving Information**

**Driving for Better Energy Efficiency**

Use the following tips to help maximize energy efficiency and driving range.

In colder temperatures, while these efficiency tips will help, the driving range will be lower due to higher energy usage including energy spent heating the cabin.

The Energy Information screen estimates the influence of the main factors impacting vehicle range. After charging is complete, this information is reset. See “Energy Usage” under *Energy Information* ⇨ 116.

**Acceleration/Braking/Coasting**

Avoid rapid accelerations and decelerations.

Driving range is maximized at 89 km/h (55 mph) and less.

Use cruise control when appropriate.

Plan ahead for decelerations and coast whenever possible. Do not rush to traffic signals. Do not shift to N (Neutral) to coast.

Using the steering wheel paddle during deceleration recovers more energy. See *Regenerative Braking* ⇨ 190.

**Terrain and Vehicle Speed**

Higher speeds and grade changes use more energy and can significantly reduce driving range.

**Climate Setting**

Using the heat and air conditioning systems decreases the energy available for electric driving.

Optimal energy efficiency is achieved when the heat, air conditioning, and fan are turned off.

Use the heated seat features instead of climate control system. Heating the seat uses less energy than heating and cooling the interior.

Use remote start to heat or cool the interior when the vehicle is plugged in to maximize the driving range by using electricity from the electrical outlet.

In hot weather, avoid parking in direct sunlight or use sunshades inside the vehicle.

Keep the inside of the windows clean to reduce fogging. Turn off the front defroster and rear defogger when they are not needed.

Avoid driving with the windows open at highway speeds.

Use the Battery Gauge on the Instrument Cluster to view the effect of climate control settings on your estimated driving range. See *Battery Gauge (High Voltage)* ⇨ 98.

### Outside Temperature

On colder days, it is best to plug in the vehicle overnight, then remote start the vehicle.

Allow the vehicle to warm up for 20 minutes before driving.

If possible, use a level 2 (240 volt) high power charge station for best results. This allows the interior of the vehicle and high voltage battery to warm to the optimal temperature.

## Vehicle Charging/Maintenance

### Charging

Keep the vehicle plugged in, even when fully charged, to maintain the battery temperature ready for the next drive. This is important when outside temperatures are extremely hot or cold.

### Maintenance

Always keep the tires properly inflated and the vehicle properly aligned.

The weight of excess cargo in the vehicle affects efficiency and driving range. Avoid carrying more than is needed.

Avoid unnecessary use of electrical accessories. Power used for functions other than propelling the vehicle will reduce driving range.

Using a rooftop carrier will reduce efficiency due to additional weight and drag.

### Distracted Driving

Distraction comes in many forms and can take your focus from the task of driving. Exercise good judgment and do not let other activities divert your attention away from the road. Many local governments have

enacted laws regarding driver distraction. Become familiar with the local laws in your area.

To avoid distracted driving, keep your eyes on the road, keep your hands on the steering wheel, and focus your attention on driving.

- Do not use a phone in demanding driving situations. Use a hands-free method to place or receive necessary phone calls.
- Watch the road. Do not read, take notes, or look up information on phones or other electronic devices.
- Designate a front seat passenger to handle potential distractions.
- Become familiar with vehicle features before driving, such as programming favorite radio stations and adjusting climate control and seat settings. Program all trip information into any navigation device prior to driving.
- Wait until the vehicle is parked to retrieve items that have fallen to the floor.
- Stop or park the vehicle to tend to children.
- Keep pets in an appropriate carrier or restraint.



- Avoid stressful conversations while driving, whether with a passenger or on a cell phone.

 **Warning**

Taking your eyes off the road too long or too often could cause a crash resulting in injury or death. Focus your attention on driving.

Refer to the infotainment section for more information on using that system and the navigation system, if equipped, including pairing and using a cell phone.

## Defensive Driving

Defensive driving means “always expect the unexpected.” The first step in driving defensively is to wear the seat belt. See *Seat Belts* ⇨ 46.

- Assume that other road users (pedestrians, bicyclists, and other drivers) are going to be careless and make mistakes. Anticipate what they may do and be ready.
- Allow enough following distance between you and the driver in front of you.
- Focus on the task of driving.

## Impaired Driving

Death and injury associated with impaired driving is a global tragedy.

 **Warning**

Drinking alcohol or taking drugs and then driving is very dangerous. Your reflexes, perceptions, attentiveness, and judgment can be affected by even a small amount of alcohol or drugs. You can have a serious — or even fatal — collision if you drive after drinking or taking drugs.

Do not drive while under the influence of alcohol or drugs, or ride with a driver who has been drinking or is impaired by drugs. Find alternate transportation home; or if you are with a group, designate a driver who will remain sober.

## Control of a Vehicle

Braking, steering, and accelerating are important factors in helping to control a vehicle while driving.

## Braking

Braking action involves perception time and reaction time. Deciding to push the brake pedal is perception time. Actually doing it is reaction time.

Average driver reaction time is about three-quarters of a second. In that time, a vehicle moving at 100 km/h (60 mph) travels 20 m (66 ft), which could be a lot of distance in an emergency.

Helpful braking tips to keep in mind include:

- Keep enough distance between you and the vehicle in front of you.
- Avoid needless heavy braking.
- Keep pace with traffic.

## Steering

**Caution**

To avoid damage to the steering system, do not drive over curbs, parking barriers, or similar objects at speeds greater than 3 km/h (1 mph). Use care when driving over other objects such as lane dividers and speed bumps. Damage caused by misuse of the vehicle is not covered by the vehicle warranty.

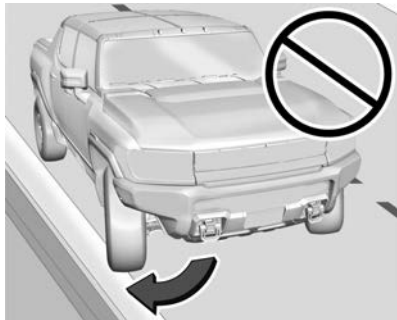

### Electric Power Steering

The vehicle is equipped with an electric power steering system, which reduces the amount of effort needed to steer the vehicle. It does not have power steering fluid. Regular maintenance is not required.

If the vehicle experiences a system malfunction and loses power steering, greater steering effort may be required. Power steering assist also may be reduced if you turn the steering wheel as far as it can turn and hold it there with force for an extended period of time.

See your dealer if there is a problem.

### Four-Wheel Steering

#### Automatic Mode

The rear wheels turn in the opposite direction of the front wheels at low vehicle speed.

The rear wheels turn in the same direction as the front wheels at a vehicle speed greater than 25 mph.

See *Driver Mode Control* ⇨ 194 to set Automatic Mode.

#### CrabWalk Mode

The front and rear wheels turn in the same direction when the vehicle speed is below 20 mph

See *Four-Wheel Steering (Including Crabwalk)* ⇨ 196 to set CrabWalk Mode.

### Curve Tips

- Take curves at a reasonable speed.
- Reduce speed before entering a curve.
- Maintain a reasonable steady speed through the curve.
- Wait until the vehicle is out of the curve before accelerating gently into the straightaway.

### Steering in Emergencies

- There are some situations when steering around a problem may be more effective than braking.
- Holding both sides of the steering wheel allows you to turn 180 degrees without removing a hand.
- Antilock Brake System (ABS) allows steering while braking.

### Off-Road Recovery

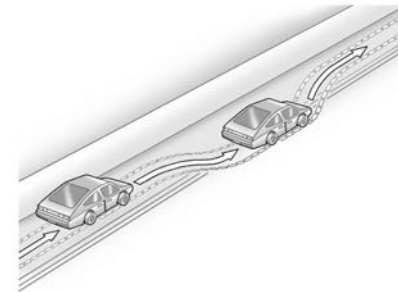

The vehicle's right wheels can drop off the edge of a road onto the shoulder while driving. Follow these tips:

1. Ease off the accelerator and then, if there is nothing in the way, steer the vehicle so that it straddles the edge of the pavement.
2. Turn the steering wheel about one-eighth of a turn, until the right front tire contacts the pavement edge.
3. Turn the steering wheel to go straight down the roadway.

## Loss of Control

### Skidding

There are three types of skids that correspond to the vehicle's three control systems:

- **Braking Skid** — wheels are not rolling.
- **Steering or Cornering Skid** — too much speed or steering in a curve causes tires to slip and lose cornering force.
- **Acceleration Skid** — too much throttle causes the driving wheels to spin.

Defensive drivers avoid most skids by taking reasonable care suited to existing conditions, and by not overdriving those conditions. But skids are always possible.

If the vehicle starts to slide, follow these suggestions:

- Ease your foot off the accelerator pedal and steer the way you want the vehicle to go. The vehicle may straighten out. Be ready for a second skid if it occurs.
- Slow down and adjust your driving according to weather conditions. Stopping distance can be longer and vehicle control can be affected when traction is reduced by water, snow, ice, gravel, or other material on the road. Learn to recognize warning clues — such as enough water, ice, or packed snow on the road to make a mirrored surface — and slow down when you have any doubt.
- Try to avoid sudden steering, acceleration, or braking, including reducing vehicle speed by shifting to a lower gear. Any sudden changes could cause the tires to slide.

Remember: Antilock brakes help avoid only the braking skid.

### Off-Road Driving

Four-wheel-drive vehicles can be used for off-road driving. Vehicles without four-wheel drive and vehicles not equipped with All Terrain (AT) or On-Off Road (OOR) tires must not be driven off-road except on a level,

solid surface. For contact information about the original equipment tires, see the warranty manual.

One of the best ways for successful off-road driving is to control the speed.

### **Warning**

When driving off-road, bouncing and quick changes in direction can easily throw you out of position. This could cause you to lose control and crash. You and your passengers should always wear seat belts.

### Off-Road Vehicle Features

If equipped, the following off-road features may be available:

- **Four-Wheel Steering (CrabWalk):** Provides the ability to steer the vehicle with all four wheels, reducing the turning diameter and improving maneuverability of the vehicle. See *Four-Wheel Steering (Including Crabwalk)* ⇨ 196.
- **Air Down Mode:** Allows the driver to set a custom tire pressure for off-road driving. See *Tire Pressure Monitor Operation* ⇨ 321.

- **Acceleration Mode (Watts to Freedom):** Enables peak horsepower and torque production that propels the vehicle rapidly from initial vehicle movement. See *Acceleration Mode (Watts to Freedom)* ⇨ 193.
- **Underbody Camera System:** Provides a view of the area underneath the vehicle to avoid obstacles during off-roading events. See *Surround Vision System* ⇨ 229.
- **Off-Road App:** Provides access to off-road performance data and to on-screen auxiliary switches for controlling vehicle accessories. See *Off-Road App* ⇨ 170.

### Before Driving Your Vehicle Off-Road

Have all necessary maintenance and service work completed.

Charge the vehicle and check inflation pressure in all tires, including the spare, if equipped.

Read all the information about four-wheel-drive vehicles in this manual.

Know the local laws that apply to off-road driving.

### Loading the Vehicle for Off-Road Driving

#### Caution

Placing tall or oversized items near or against the spoiler or the lamp above the truck bed can result in vehicle damage. To prevent vehicle damage, properly store cargo in the truck bed away from the spoiler and the lamp using the cargo tie-downs.

#### Warning

- Unsecured cargo on the load floor can be tossed about when driving over rough terrain. You or your passengers can be struck by flying objects. Secure the cargo properly.
- Keep cargo in the cargo area as far forward and as low as possible. The heaviest things should be on the floor, forward of the rear axle.
- Heavy loads on the roof raise the vehicle's center of gravity, making it more likely to roll over. You can be seriously or fatally injured if the vehicle rolls over. Put heavy loads inside the cargo area, not on the roof.

For more information about loading the vehicle, see *Vehicle Load Limits* ⇨ 176 and *Tires* ⇨ 314.

### Environmental Concerns

Always use established trails, roads, and areas that are reserved for public off-road recreational driving. Obey all posted regulations.

Do not damage shrubs, flowers, trees, grasses, or disturb wildlife.

### Driving on Hills

Driving safely on hills requires good judgment and an understanding of the vehicle's capabilities.

#### Warning

Many hills are simply too steep for any vehicle. Driving up hills can cause the vehicle to stall. Driving down hills can cause loss of control. Driving across hills can cause a rollover. You could be injured or killed. Do not drive on steep hills.

Before driving on a hill, assess the steepness, traction, and obstructions. If the terrain ahead cannot be seen, get out of the vehicle and walk the hill before driving further.

When driving on hills:

- Use L (Low) mode and keep a firm grip on the steering wheel.
- Maintain a slow speed.

### Warning

Driving to the top of a hill at high speed can cause a crash. There could be a drop-off, embankment, cliff, or even another vehicle. You could be seriously injured or killed. As you near the top of a hill, slow down and stay alert.

- When possible, drive straight up or down the hill.
- Slow down when approaching the top of the hill.
- Use headlamps even during the day to make the vehicle more visible.
- When driving down a hill, keep the vehicle headed straight down. Use low mode to slow the vehicle and help keep the vehicle under control.

### Warning

Do not coast downhill in N (Neutral) or with the vehicle turned off. See *Hill and Mountain Roads* ⇨ 174 for tips on maximizing regenerative braking and minimizing the load on the brake system. Heavy braking when going down a hill can cause your brakes to overheat and fade. This could cause loss of control and you or others could be injured or killed. Apply the brakes lightly when descending a hill and use a low mode to keep vehicle speed under control.

- Avoid turns that take the vehicle across the incline of the hill. A hill that can be driven straight up or down might be too steep to drive across. Driving across an incline puts more weight on the downhill wheels, which could cause a downhill slide or a rollover.
- Loose gravel, muddy spots, or even wet grass can cause the tires to slip sideways, downhill. If the vehicle slips sideways, it can hit something and potentially roll over.

- Hidden obstacles can make the steepness of the incline more severe. If a rock is driven across with the uphill wheels, or if the downhill wheels drop into a rut or depression, the vehicle can tilt even more.
- If an incline must be driven across, and the vehicle starts to slide, turn downhill. This should help straighten out the vehicle and prevent side slipping.

### Warning

Getting out of the vehicle on the downhill side when stopped across an incline is dangerous. If the vehicle rolls over, you could be crushed or killed. Always get out on the uphill side of the vehicle and stay well clear of the rollover path.

### **Driving in Mud, Sand, Snow, or Ice**

Use L (Low) mode when driving in mud. Keep the vehicle moving to avoid getting stuck.

Traction changes when driving on sand. On loose sand, such as on beaches or sand dunes, the tires tend to sink into the sand.

This affects steering, accelerating, and braking. Drive at a reduced speed and avoid sharp turns or abrupt maneuvers.

Traction is reduced on hard-packed snow and ice and it is easy to lose control. Reduce vehicle speed when driving on hard-packed snow and ice.

### Warning

Driving on frozen lakes, ponds, or rivers can be dangerous. Ice conditions vary greatly and the vehicle could fall through the ice; you and your passengers could drown. Drive your vehicle on safe surfaces only.

### Water Fording

Your vehicle is capable of driving in varying water depths.

- Normal Height Ground Clearance – up to 66 cm (26 in)
- Increased Height Ground Clearance – 71 cm (28 in)
- Extract Mode (if equipped) – 81 cm (32 in)



### Warning

Driving in water can cause loss of vehicle control or vehicle damage. As water depths increase, reduce the vehicle speed.

- Never drive through water deeper than the driver's side front gravel guard behind the front tire.
- Be aware of submerged obstacles.
- Never open your doors while in water.

### Warning

Driving through flowing water can be dangerous and have an unpredictable effect on vehicle control. Even shallow water can wash away the ground from under your tires. Traction could be lost, the vehicle could be swept downstream or the vehicle could roll over. Do not drive through rushing water.

### Caution

Do not drive through standing water if it is deep enough to cover the gravel guards. Deep water can damage vehicle parts.

Before driving in water:

- Determine the depth of the water.
- Enter the water slowly. If the water is deeper than the center of the front hubs, never exceed 5 km/h (3 mph).
- Always drive in the direction of the current.
- Avoid oncoming vehicles as they will increase the water depth surrounding your vehicle.

- After exiting the water, repeatedly and gently apply the brakes to dry them off and restore effectiveness.

### If Something Goes Wrong

If during your off-road experience a warning light or warning message displays on the instrument cluster, or if the vehicle sustains damage, stop driving as soon as it is safe to do so. Correct the condition if possible before continuing driving. If a warning light or message appears, or if the condition cannot be corrected, see your dealer. See *Vehicle Messages* ⇨ 118.

If the vehicle is operating with reduced acceleration or reduced propulsion, stop your off-road experience and drive slowly to an accessible point for further assistance. The vehicle should be taken to your dealer for service as soon as possible. See *Propulsion Power Messages* ⇨ 118 and *Propulsion Power is Limited Light* ⇨ 102.

#### Warning

A vehicle with driveline damage may roll when shifted into P (Park). Always set the Electric Parking Brake before inspecting for driveline damage or

(Continued)

#### Warning (Continued)

when securing the vehicle on a flatbed tow truck. See *Electric Parking Brake* ⇨ 189 and *Transporting a Disabled Vehicle* ⇨ 347.

### After Off-Road Driving

Be sure to switch out of Off-Road Mode or Terrain Mode to return to normal driving. See *Driver Mode Control* ⇨ 194.

Remove any brush or debris that has collected on the underbody or chassis, or under the hood. Clean the lens of the underbody camera. These accumulations can be a fire hazard.

The extreme conditions of off-road driving require more frequent maintenance service. See "Severe Conditions Requiring More Frequent Maintenance" and "Additional Required Services — Severe Service" on *Maintenance Schedule* ⇨ 359.

After operation in mud or sand, have the brake linings cleaned and checked. These substances can cause glazing and uneven braking.

Check the body structure, driveline, steering, suspension, wheels, tires, and other vehicle systems for damage, or have these inspections done by your dealer.

#### Warning

Lifting a vehicle and getting under it to do maintenance or repairs is dangerous without the appropriate safety equipment and training. If a jack is provided with the vehicle, it is designed only for changing a flat tire. If it is used for anything else, you or others could be badly injured or killed if the vehicle slips off the jack. If a jack is provided with the vehicle, only use it for changing a flat tire.

### Off-Road App

#### Overview

The vehicle is equipped with an Off-Road App to assist in monitoring the motion and status of your vehicle, which can be beneficial in off-road environments. See *Off-Road Driving* ⇨ 166.

The Off-Road App displays data such as the vehicle's pitch/roll angle, compass bearing, drift angle, suspension travel and more, depending on how your vehicle is equipped. Some gauges track of the maximum values you have achieved, and you can reset the values to start over.

It is possible to display certain content from the Off-Road App as a widget in the Card View area on the right side of the infotainment screen. This way, the off-road data stays in view while you continue using other features like audio or navigation. If you have a passenger in the vehicle, they can help you monitor the information on the screen while you are driving.

### Warning

Taking your eyes off the road for too long or too often while using any infotainment feature can cause a crash. You or others could be injured or killed. Do not give extended attention to infotainment tasks while driving. Limit your glances at the vehicle displays and focus your attention on driving. Use voice commands whenever possible.

## Getting Started

To open the app, select the OFF-ROAD icon from the infotainment home screen. The available off-road tools are displayed in two ways: icons for the tools appear in a column at left, and detailed widgets for the tools display horizontally. Scroll either up/down or left/right to view more icons or widgets.

If a gauge for a tool shows minimum and maximum values, touch the RESET icon on the screen to reset the minimum or maximum value.

The available off-road tools may include:

**Air Down mode** : Lets you set a custom tire pressure for better traction during off-road driving. See *Tire Pressure Monitor Operation* ⇨ 327.

**Altimeter** : Displays current elevation. Maintains lowest and highest values, which can be reset as needed.

**Axle locker status** : Identifies each axle as locked or unlocked. A tire will be highlighted if slip due to low traction is detected. See *Locking Front Axle* ⇨ 200 and *Locking Rear Axle* ⇨ 199.

**Camera app shortcut** : Launches the Camera App for exterior camera views. See *Surround Vision System* ⇨ 229.

**Compass** : Displays direction of travel. If using the vehicle navigation, the GPS coordinates of your destination are also displayed.

**G-Force and drift** : Displays acceleration, drift angle, max drift, and max G-force.

**On-screen auxiliary (AUX) switches** : Enables control of aftermarket accessories without a physical button. See “On-Screen Auxiliary Switches” later in this section.

**Pitch and roll** : Shows real-time vehicle pitch and roll in a 3D gauge.

**Ride height** : Represents height as the suspension is raised or lowered. Will reflect real-time change to ride height mode. See *Air Suspension* ⇨ 201.

**Steering angle** : Displays degrees of tilt for front and rear tires.

**Suspension travel** : Depicts up-and-down movement of each tire as you traverse over different terrain.



**Tire pressure** : Displays real-time tire pressure plus indicator for over- or under-inflation. See *Tire Pressure Monitor System* ⇨ 320.

**Torque output** : Real-time display of torque output compared to peak available torque.

**Torque vectoring** : Displays how torque is being distributed to each wheel.

### On-Screen Auxiliary Switches

If equipped, certain aftermarket accessories can be controlled through programmable on-screen auxiliary switches inside the Off-Road App. This feature requires user installation of an auxiliary switch interface module, which is mounted under the hood. When an aftermarket accessory such as off-road lighting is installed onto the vehicle, it will be hard-wired to one of the connections on the auxiliary switch interface module. See your dealer.

Six on-screen auxiliary switches are available. You can assign each on-screen switch a label and icon of your choosing to match the installed accessory. Assigning unique icons to the on-screen auxiliary switches will help you recognize them on views where there is not enough room to show the text labels.

If the optional auxiliary switch interface module is not installed, a message “No accessory connected to this switch” displays when you touch an on-screen auxiliary switch.

If you want to relocate control of an accessory to a different on-screen auxiliary switch, for example from AUX 5 to AUX 2, you would need to move the physical connection of the accessory on the auxiliary switch interface module.

There are several ways to display the auxiliary switches on the screen. The switches display in different sizes depending on the view selected. You can rotate among these views at any time.

- **Card View:** Enables access to the auxiliary switches alongside other infotainment features. To access Card View, swipe up or down on the right-hand side of the infotainment screen to bring the Off-Road content into view.
- **Pro View:** Provides access to all auxiliary switches while simultaneously viewing several widgets. To access Pro View, select the H icon from within the Off-Road App. You may also define which switches you want to see in this view. If you do not use all six switches, you can remove the

unused switches from Pro View. The available switches will be resized larger and will be easier to touch.

- **AUX Control Panel:** Shows the switch icons in their largest possible size for ease of use while driving on off-road terrain that may make accurate screen touches difficult. To access the AUX Control Panel, select the AUX icon within the Off-Road App.
- To customize an on-screen auxiliary switch:
1. While the vehicle is in P (Park), touch the OFF-ROAD icon on the infotainment display.
  2. Touch the AUX icon from within the app.
  3. Touch the pencil icon in the lower-left corner of the display to enter Edit mode.
  4. Touch the switch you want to customize.
    - To enter a new label for the switch, touch the name field and type in a new label. To save your update, close the keyboard.
    - To change the icon, touch a new one on the list.

- Review the additional options listed below the name field. Touch the checkbox next to the option description to enable or disable the option.

**Turn on only while switch is held down:** When this option is enabled, the switch will only operate while your finger continues to touch and hold the on-screen switch. This may be useful for accessories that only need to be turned on for short intervals.

**Turn on parking lights while switch is on:** When this option is enabled, the vehicle parking lights will automatically turn on while the switch is in use. This may be particularly useful to use for a light bar, as it will help ensure your vehicle remains visible while driving in low-light conditions with the headlights off.

5. To save your customizations for the on-screen switch, touch the BACK icon.

## Driving on Wet Roads

Rain and wet roads can reduce vehicle traction and affect your ability to stop and accelerate. Always drive slower in these types of driving conditions and avoid driving through large puddles and deep-standing or flowing water.

### Warning

Wet brakes can cause crashes. They might not work as well in a quick stop and could cause pulling to one side. You could lose control of the vehicle.

After driving through a large puddle of water or a car/vehicle wash, lightly apply the brake pedal until the brakes work normally.

Flowing or rushing water creates strong forces. Driving through flowing water could cause the vehicle to be carried away. If this happens, you and other vehicle occupants could drown. Do not ignore police warnings and be very cautious about trying to drive through flowing water.

## Hydroplaning

Hydroplaning is dangerous. Water can build up under the vehicle's tires so they actually ride on the water. This can happen if the road is wet enough and you are going fast enough. When the vehicle is hydroplaning, it has little or no contact with the road.

There is no hard and fast rule about hydroplaning. The best advice is to slow down when the road is wet.

## Other Rainy Weather Tips

Besides slowing down, other wet weather driving tips include:

- Allow extra following distance.
- Pass with caution.
- Keep windshield wiping equipment in good shape.
- Keep the windshield washer fluid reservoir filled.
- Have good tires with proper tread depth. See *Tires* ⇨ 314.
- Turn off cruise control.

## Hill and Mountain Roads

### Warning

Do not charge your vehicle's battery above an 80% charge if you are going to drive down long, steep grades such as mountain passes. This provides room in the battery for regenerative braking to supplement your conventional brakes during the descent. This is especially important when towing a trailer, which puts additional stress on your vehicle's braking system.

If the battery becomes full, regenerative braking will be limited or unavailable. The brakes will have to do all the work of slowing down the vehicle and could become too hot. Hot brakes may not be able to slow the vehicle enough to maintain speed and control. To help avoid the risk of a crash, limit the battery's charge and, if you experience brake fade or receive a brake warning, stop the vehicle and allow the brakes to cool.

See "Charge Now" under *Charging* ⇨ 109 for information on setting charge limits.

Driving on steep hills or through mountains is different than driving on flat or rolling terrain. Be sure to:

- Use regenerative braking to help slow the vehicle or maintain speed by keeping the vehicle in gear and limiting the initial battery charge to 80% or less.
- When braking is necessary, use frequent, light taps of the brake pedal. This maximizes regenerative braking and minimizes the load on the vehicle brake system.
- Keep the vehicle serviced and in good shape.
- Check all fluid levels, brakes, tires and cooling system.
- Drive at speeds that keep the vehicle in its own lane. Do not swing wide or cross the center line.
- Be alert on top of hills; something could be in your lane (e.g., stalled car, crash).
- Pay attention to special road signs (e.g., falling rocks area, winding roads, long grades, passing or no-passing zones) and take appropriate action.

## Winter Driving

### Driving on Snow or Ice

#### Caution

To avoid damage to the wheels and brake components, always clear snow and ice from inside the wheels and underneath the vehicle before driving.

Snow or ice between the tires and the road creates less traction or grip, so drive carefully. Wet ice can occur at about 0 °C (32 °F) when freezing rain begins to fall. Avoid driving on wet ice or in freezing rain until roads can be treated.

#### For Slippery Road Driving:

- Turn off One-Pedal Driving.
- Accelerate gently. Accelerating too quickly causes the wheels to spin and makes the surface under the tires slick.
- Turn on the Traction Control System (TCS).
- The Antilock Brake System (ABS) improves vehicle stability during hard stops, but the brakes should be applied sooner than when on dry pavement.

- Allow greater following distance and watch for slippery spots. Icy patches can occur on otherwise clear roads in shaded areas. The surface of a curve or an overpass can remain icy when the surrounding roads are clear. Avoid sudden steering maneuvers and braking while on ice.
- Turn off cruise control.
- Avoid using Regen on Demand paddle.

### Blizzard Conditions

Being stuck in snow can be a serious situation. Stay with the vehicle unless there is help nearby. If possible, use Roadside Assistance. See *Roadside Assistance Program* ⇨ 369. To get help and keep everyone in the vehicle safe:

- Turn on the hazard warning flashers.
- Tie a red cloth to an outside mirror.

To save energy, run the vehicle for only short periods as needed to warm the vehicle and then shut the vehicle off and partially close the window. Moving about to keep warm also helps.

### If the Vehicle Is Stuck

Slowly and cautiously spin the wheels to free the vehicle when stuck in sand, mud, ice, or snow. See “Rocking the Vehicle to Get It Out” later in this section.

The Traction Control System (TCS) can often help to free a stuck vehicle. See *Traction Control/Electronic Stability Control* ⇨ 191. If TCS cannot free the vehicle, see “Rocking the Vehicle to Get it Out” following.

#### Warning

If the vehicle's tires spin at high speed, they can explode, and you or others could be injured. Spin the wheels as little as possible and avoid going above 56 km/h (35 mph).

For information about using tire chains on the vehicle, see *Tire Chains* ⇨ 332.

### Rocking the Vehicle to Get It Out

Turn the steering wheel left and right to clear the area around the front wheels. Turn the TCS off. Shift back and forth between R (Reverse) and a forward gear, spinning the wheels as little as possible. To prevent battery wear, wait until the wheels stop

spinning before shifting gears. Slowly spinning the wheels in the forward and reverse directions causes a rocking motion that could free the vehicle. If that does not get the vehicle out after a few tries, it might need to be towed out. See *Transporting a Disabled Vehicle* ⇨ 347. Recovery hooks can be used.

### Recovery Tow Hooks

Recovery tow hooks are used only to free, or recover, the vehicle if stuck off-road. Always pull the vehicle straight forward or straight rearward using the front or rear tow hooks. If the vehicle must be towed, proper towing equipment is required. See *Transporting a Disabled Vehicle* ⇨ 347.

When not in use, stow the tow hooks in the downward position prior to operating the vehicle.

#### Warning

Never pull sideways on the tow hooks. The hooks could break and you and others could be injured. Always pull the vehicle straight forward or straight rearward.

**Caution**

Never use recovery hooks to tow the vehicle. The vehicle could be damaged, and the repairs would not be covered by the vehicle warranty.



Front Tow Hooks

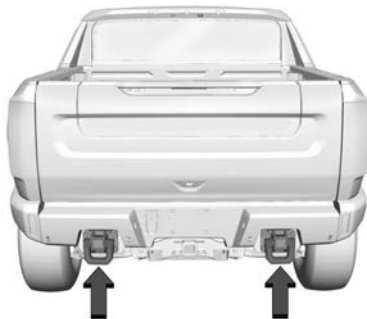

Rear Tow Hooks (If equipped)

**Vehicle Load Limits**

It is very important to know how much weight the vehicle can carry. This weight is called the vehicle capacity weight and includes the weight of all occupants, cargo, and all nonfactory-installed options. Two labels on the vehicle may show how much weight it was designed to carry: the Tire and Loading Information label and the Certification/Tire label.

**Warning**

Do not load the vehicle any heavier than the Gross Vehicle Weight Rating (GVWR), or either the maximum front or rear Gross Axle Weight Rating (GAWR). This can cause systems to break and change the way the vehicle handles. This could cause loss of control and a crash. Overloading can also reduce stopping performance, damage the tires, and shorten the life of the vehicle.

**Tire and Loading Information Label**

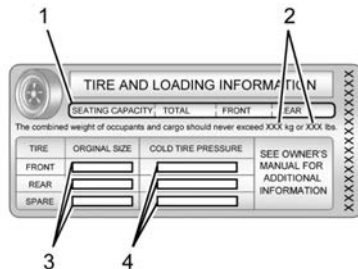

Label Example

A vehicle-specific Tire and Loading Information label is attached to the center pillar (B-pillar). The Tire and Loading Information label shows the number of occupant seating positions (1), and the maximum vehicle capacity weight (2) in kilograms and pounds.

The Tire and Loading Information label also shows the size of the original equipment tires (3) and the recommended cold tire inflation pressures (4). For more information on tires and inflation see *Tires* ⇨ 314 and *Tire Pressure* ⇨ 319.

There is also important loading information on the vehicle Certification/Tire label. It may show the Gross Vehicle Weight Rating (GVWR) and the Gross Axle Weight Rating (GAWR) for the front and rear axles. See “Certification/Tire Label” later in this section.

#### “Steps for Determining Correct Load Limit–

1. Locate the statement “The combined weight of occupants and cargo should never exceed XXX kg or XXX lbs.” on your vehicle’s placard.
2. Determine the combined weight of the driver and passengers that will be riding in your vehicle.
3. Subtract the combined weight of the driver and passengers from XXX kg or XXX lbs.
4. The resulting figure equals the available amount of cargo and luggage load capacity. For example, if the “XXX” amount equals 1400 lbs. and there will be five 150 lb passengers in your vehicle, the amount of available cargo and luggage load capacity is 650 lbs. (1400-750 (5 x 150) = 650 lbs.)
5. Determine the combined weight of luggage and cargo being loaded on the vehicle. That weight may not safely exceed the available cargo and luggage load capacity calculated in Step 4.

6. If your vehicle will be towing a trailer, load from your trailer will be transferred to your vehicle. Consult this manual to determine how this reduces the available cargo and luggage load capacity of your vehicle.”

See *Trailer Towing* ⇨ 266 for important information on towing a trailer, towing safety rules, and trailering tips.

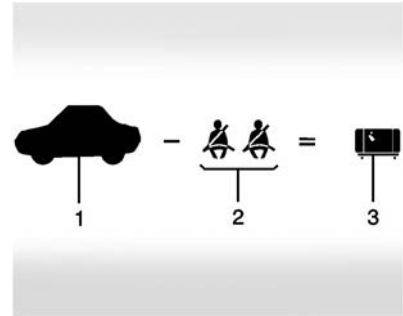

**Example 1**

1. Vehicle Capacity Weight for Example 1 = (453 kg) (1,000 lb)
2. Subtract Occupant Weight @ 68 kg (150 lb) × 2 = 136 kg (300 lb)

3. Available Occupant and Cargo Weight = 317 kg (700 lb)

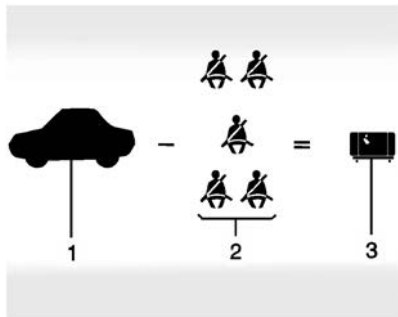

Example 2

1. Vehicle Capacity Weight for Example 2 = 453 kg (1,000 lb)
2. Subtract Occupant Weight @ 68 kg (150 lb) × 5 = 340 kg (750 lb)
3. Available Cargo Weight = 113 kg (250 lb)

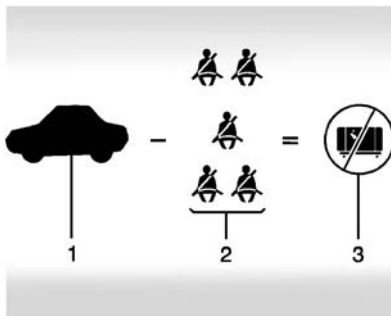

Example 3

1. Vehicle Capacity Weight for Example 3 = 453 kg (1,000 lb)
2. Subtract Occupant Weight @ 91 kg (200 lb) × 5 = 453 kg (1,000 lb)
3. Available Cargo Weight = 0 kg (0 lb)

Refer to the Tire and Loading Information label for specific information about the vehicle's capacity weight and seating positions. The combined weight of the driver, passengers, and cargo should never exceed the vehicle's capacity weight.

### Certification/Tire Label

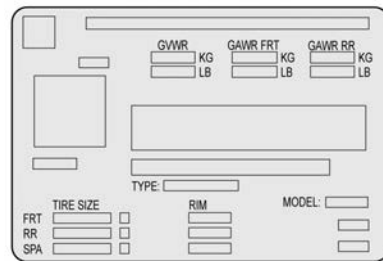

A vehicle-specific Certification/Tire label is attached to the center pillar (B-pillar). The label may show the size of the vehicle's original tires and the inflation pressures needed to obtain the gross vehicle weight capacity of the vehicle. This is called Gross Vehicle Weight Rating (GVWR). The GVWR includes the weight of the vehicle, all occupants, and cargo.

The Certification/Tire label also may show the maximum weights for the front and rear axles, called Gross Axle Weight Rating (GAWR). To determine

the actual loads on the front and rear axles, weigh the vehicle at a weigh station. Your dealer can help with this. Be sure to spread the load equally on both sides of the centerline.

The Certification/Tire label also contains important information about the Front Axle Reserve Capacity.

### Warning

In the case of a sudden stop or collision, things carried in the bed of your truck could shift forward and come into the passenger area, injuring you and others. If you put things in the bed of your truck, you should make sure they are properly secured.

### Caution

Overloading the vehicle may cause damage. Repairs would not be covered by the vehicle warranty. Do not overload the vehicle.

Using heavier suspension components to get added durability might not change the weight ratings. Ask your dealer to help load the vehicle the right way.

### Warning

Things you put inside the vehicle can strike and injure people in a sudden stop or turn, or in a crash.

- Put things in the cargo area of the vehicle. Try to spread the weight evenly.
- Never stack heavier things, like suitcases, inside the vehicle so that some of them are above the tops of the seats.
- Do not leave an unsecured child restraint in the vehicle.
- When you carry something inside the vehicle, secure it whenever you can.
- Do not leave a seat folded down unless you need to.

There is also important loading information for off-road driving in this manual. See “Loading the Vehicle for Off-Road Driving” under *Off-Road Driving* ⇨ 166.

### Add-On Equipment

When carrying removable items, a limit on how many people carried inside the vehicle may be necessary. Be sure to weigh the vehicle before buying and installing the new equipment.

### Caution

Overloading the vehicle may cause damage. Repairs would not be covered by the vehicle warranty. Do not overload the vehicle.

Remember not to exceed the Gross Axle Weight Rating (GAWR) of the front or rear axle.

### Truck-Camper Loading Information

The vehicle was neither designed nor intended to carry a slide-in camper.



**Caution**

Adding a slide-in camper or similar equipment to the vehicle can damage it, and the repairs would not be covered by the vehicle warranty. Do not install a slide-in camper or similar equipment on the vehicle.

**Starting and Operating**

**New Vehicle Break-In**

**Caution**

Avoid making hard stops for the first 322 km (200 mi). During this time the new brake linings are not yet broken in. Hard stops with new linings can mean premature wear and earlier replacement. Follow this breaking-in guideline every time you get new brake linings. Following break-in, vehicle speed and load can be gradually increased.

**Power Button**

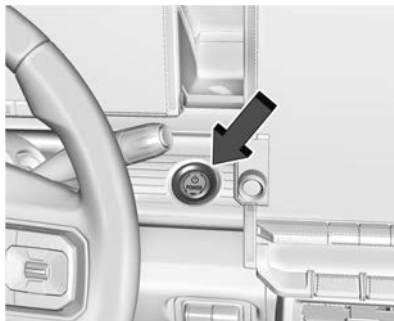



The vehicle has an electronic pushbutton start.

The remote key must be in the vehicle for the system to operate. If the vehicle will not start, place the remote key in the transmitter pocket, inside the center console.

**ON/RUN** : This position is for starting and driving. With the vehicle off, and the brake pedal applied, pressing POWER  once will place the vehicle in ON/RUN. When the vehicle ready light is on in the instrument cluster, the vehicle is ready to be driven. This could take up to 15 seconds at extremely cold temperatures.

**Service Mode**

This power mode is available for service and diagnostics, and to verify the proper operation of the service vehicle soon light as may be required for emission inspection purposes. With the vehicle off, and the brake pedal not applied, pressing and holding POWER  for more than five seconds will place the vehicle in Service Mode. The instruments and audio systems will operate as they do in ON/RUN, but the vehicle will not be able to be driven. The propulsion system will not start in Service Mode. Press POWER  again to turn the vehicle off.

**Caution**

Placing the vehicle in Service Mode will use the 12-volt battery. Do not use Service Mode for an extended period, or the vehicle may not start.

**STOPPING THE VEHICLE/OFF** : To turn the vehicle off, apply the brakes, press the button on top of the shift lever to shift to P (Park) and press POWER .

Alternatively, apply the brakes and press POWER . The electric drive unit will shift to P (Park) then shut off automatically.

Retained Accessory Power (RAP) will remain active until the driver door is opened.

If the vehicle must be shut off in an emergency:

1. Brake using a firm and steady pressure. Do not pump the brakes repeatedly. This may deplete power assist, requiring increased brake pedal force.
2. Shift the vehicle to N (Neutral). This can be done while the vehicle is moving. After shifting to N (Neutral), firmly apply the brakes and steer the vehicle to a safe location.
3. Come to a complete stop, shift to P (Park), and turn the vehicle off by pressing POWER .
4. Set the parking brake.

### Warning

Turning off the vehicle while moving may disable the airbags. While driving, only shut the propulsion system off in an emergency.

If the vehicle cannot be pulled over, and must be shut off while driving, press and hold POWER  for longer than two seconds, or press twice in five seconds.

## Starting and Stopping the Vehicle

### Starting Procedure

Press the P (Park) button on the shift lever, or move the shift lever into N (Neutral). The propulsion system will not start in any other position.

#### Caution

Do not try to shift to P (Park) if the vehicle is moving or the electric drive unit could be damaged. Shift to P (Park) only when the vehicle is stopped.

#### Caution

If you add electrical parts or accessories, you could change the way the vehicle operates. Any resulting damage would not be covered by the vehicle warranty.

The remote key or digital key must be in the vehicle. Press the brake pedal, then press and release POWER .

If the remote key or digital key is not in the vehicle or something is interfering with the remote key or digital key, a message displays in the Driver Information Center (DIC).

If the vehicle will not start due to a low remote key battery, the vehicle can still be driven. See *Remote Key Operation* ⇨ 7 and *Digital Key* ⇨ 16.



A vehicle ready light displays in the lower right corner of the instrument cluster when the vehicle is ready to be driven.

The instrument cluster also displays an active battery gauge when the vehicle is ready to be driven.

### Restarting Procedure

If the vehicle must be restarted while it is still moving, move the shift lever to N (Neutral) and press POWER  twice

without pressing the brake pedal. The propulsion system will not restart in any other position.

A chime will sound if the driver door is opened while the vehicle is on. Always press POWER  to turn the vehicle off before exiting.

### Stopping Procedure

For information on how to turn the vehicle off, see *Power Button* ⇨ 180.

### Retained Accessory Power (RAP)

When the vehicle is turned from on to off, the following features (if equipped) will continue to function for up to 10 minutes, or until the driver door is opened.

- Infotainment System
- Power Windows (during RAP this functionality will be lost when any door is opened)
- Auxiliary Power Outlet
- Audio System
- OnStar System

### Shifting Into Park

#### Warning

Parking on grades with poor traction such as ice, snow, mud, or gravel may cause the vehicle to unintentionally move and could result in injury, death, and/or vehicle damage. Be sure to apply the parking brake. See *Electric Parking Brake* ⇨ 189.

To shift into P (Park):

1. Hold the brake pedal down and set the parking brake. See *Electric Parking Brake* ⇨ 189.
2. Press the P (Park) switch on the top of the shift lever. See *Electric Drive Unit* ⇨ 184.
3. The P indicator on the shift lever will turn red when the vehicle is in P (Park).
4. Turn the vehicle off.

If the vehicle is shifted into P (Park) on a hill, the Electric Parking Brake (EPB) may apply automatically. The driver may not be able to release the EPB using the EPB switch. It should automatically release when the vehicle is shifted out of P (Park).

### Leaving the Vehicle with the Propulsion System On

#### Warning

It is dangerous to get out of the vehicle if the vehicle is not in P (Park) with the parking brake set. The vehicle can roll.

Do not leave the vehicle when the propulsion system is on. If you have left the propulsion system on, the vehicle can move suddenly. You or others could be injured. To be sure the vehicle will not move, even when you are on fairly level ground, always set the parking brake and press the P (Park) button. If you are towing a trailer, see *Driving Characteristics and Towing Tips* ⇨ 263.

If you have to leave the vehicle with the propulsion system on, the vehicle must be in P (Park) with the parking brake set, before leaving the vehicle. After pressing the P (Park) button, hold down the regular brake pedal. If you cannot see the P (Park) indicator in the instrument cluster, it means that the vehicle has not shifted to P (Park).

## Shifting out of Park

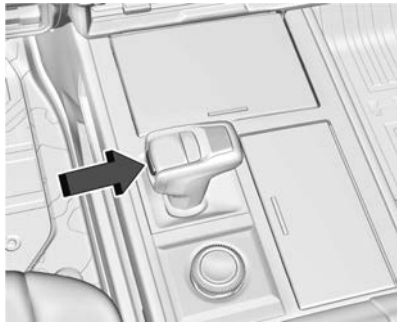

This vehicle is equipped with an electric drive unit. The shift lock release button is designed to prevent inadvertent shifting out of P (Park). To shift out of P (Park) the vehicle must be on, the brake pedal must be applied, the shift lock release button must be pressed, and the charge cord must be unplugged.

Parking the vehicle in extreme cold for several days without the charge cord connected may cause the vehicle to not start. Plug the vehicle in to allow the high voltage battery to be warmed sufficiently.

To shift out of P (Park):

1. Apply the brake pedal.

2. Press POWER  to start the vehicle.
3. Verify that the vehicle is unplugged and the vehicle ready light is on.
4. Press the shift lock release button.
5. Move the shift lever to the desired position.

After releasing the shift lever, it will return to the center position.

The P indicator will turn white and the gear indicator on the shift lever will turn red when the vehicle is no longer in P (Park).

If equipped, the Buckle to Drive feature may prevent shifting from P (Park). See *Buckle To Drive* ⇨ 47.

If the vehicle cannot shift from P (Park), a Driver Information Center (DIC) message may be displayed. Check that the vehicle is on, the vehicle ready light is on, and the brake pedal is applied when you are attempting to shift out of P (Park). If all of these conditions are met but the vehicle will not shift out of P (Park), see your dealer for service.

## Extended Parking

It is best not to park with the propulsion system on. If the vehicle is left on, be sure it will not move.

See *Shifting Into Park* ⇨ 182.

If the vehicle is left parked and on with the remote key outside the vehicle, it will remain on for up to one hour.

If the vehicle is left parked and on with the remote key inside the vehicle, it will remain on for up to two hours.

The timer will reset if the vehicle is taken out of P (Park) while it is on.

See *Remote Key Operation* ⇨ 7 and *Digital Key* ⇨ 16.

## Electric Drive Unit



The vehicle uses an electric drive unit. The shift pattern is displayed on the top of the shift lever. The selected gear position illuminates red on the shift lever, while all others will be displayed in white. If the shift is not immediate, as in very cold conditions, the indicator on the shift switch may blink until it is fully engaged.

If POWER  is pressed twice while at a relatively high speed, the vehicle will turn off and automatically shift to N (Neutral). Once the vehicle is stopped, P (Park) can be selected.

**P** : This position locks the drive wheels. Use P (Park) when starting the vehicle to prevent the vehicle from moving easily.

### Warning

It is dangerous to get out of the vehicle if the vehicle is not in P (Park) with the parking brake set. The vehicle can roll.

Do not leave the vehicle when the propulsion system is on. If you have left the propulsion system on, the vehicle can move suddenly. You or others could be injured. To be sure the vehicle will not move, even when you are on fairly level ground, always set the parking brake and press the P (Park) button. See *Shifting Into Park* ⇨ 182. If you are towing a trailer, see *Driving Characteristics and Towing Tips* ⇨ 263.

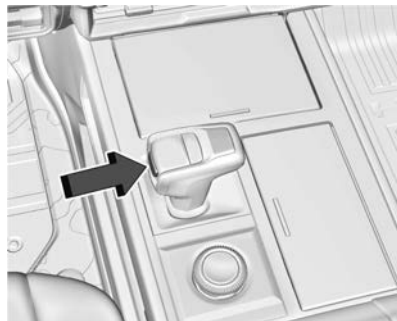

The shift lock release button is designed to prevent inadvertent shifting out of P (Park) unless the vehicle is on, the brake pedal is applied, and the shift lock release button is pressed.

When the vehicle is stopped, press POWER  to turn off the vehicle. The vehicle will shift to P (Park) automatically.

The vehicle will not shift into P (Park) if it is moving too fast. Stop the vehicle and shift into P (Park).

To shift in and out of P (Park), see *Shifting Into Park* ⇨ 182 and *Shifting out of Park* ⇨ 183.

**R** : Use this gear to back up.

If the vehicle is shifted from either R (Reverse) to D (Drive) or L (Low), or D (Drive) or L (Low) to R (Reverse) while the speed is too high, the vehicle may shift to N (Neutral). Reduce the vehicle speed and try the shift again.

To shift into R (Reverse):

1. Bring the vehicle to a complete stop.
2. Press and hold the shift lock release button on the side of the shift lever.
3. From the center position, move the shift lever forward to R (Reverse). R will be illuminated in red.
4. After releasing the shift lever, it will return to the center position.

To shift out of R (Reverse):

1. Bring the vehicle to a complete stop.
2. Shift to the desired gear.
3. After releasing the shift lever, it will return to the center position.

At low vehicle speeds, R (Reverse) can be used to rock the vehicle back and forth to get out of snow, ice, or sand without damaging the electric drive unit. See *If the Vehicle Is Stuck* ⇨ 175.

**N** : In this position, the propulsion system is inactive. If the vehicle is moving and turned off, restart the propulsion system in N (Neutral) only.

If the vehicle is left in N (Neutral) for a prolonged period of time the 12V battery will be drained.

To shift into N (Neutral):

1. Move the shift lever forward to N (Neutral).
  - If the vehicle is in P (Park), apply the brake pedal and press the shift lock release button while moving the shift lever forward.
  - The N indicator will illuminate in red.
2. After releasing the shift lever, it will return to the center position.

To shift out of N (Neutral):

1. Bring the vehicle to a complete stop.
2. Hold the brake pedal down.
3. Shift to the desired gear.

If the brake pedal is not applied, the vehicle may remain in N (Neutral).

## Car Wash Mode

This vehicle includes a Car Wash Mode that allows the vehicle to remain in N (Neutral) for use in automatic car washes.

Car wash mode is not to be used for recreational vehicle towing. If the vehicle is disabled and needs to be towed, see *Transporting a Disabled Vehicle* ⇨ 347.

### Caution

The vehicle is not designed to stay in N (Neutral) for extended periods of time. It will automatically shift into P (Park) if left in Car Wash Mode.

## Car Wash Mode (Vehicle Off – Driver in Vehicle)

To place the vehicle in N (Neutral) with the engine off and the vehicle occupied:

1. Drive to the entrance of the car wash.
2. Apply the brake pedal.
3. Shift to N (Neutral).
4. Turn off the vehicle and release the brake pedal.
5. The indicator should continue to show N. If it does not, turn the vehicle on and repeat Steps 2–4.

6. The vehicle is now ready for the car wash.

**Car Wash Mode (Vehicle Off – Driver Out of Vehicle)**

To place the vehicle in N (Neutral) with the vehicle off and the vehicle unoccupied:

1. Drive to the entrance of the car wash.
2. Apply the brake pedal.
3. Open the door.
4. Shift to N (Neutral).
5. Turn off the vehicle and release the brake pedal.
6. The indicator should continue to show N. If it does not, turn the vehicle on and repeat Steps 2–5.
7. Exit the vehicle and close the door. The vehicle is now ready for the car wash.
8. The vehicle may automatically shift to P (Park) upon re-entry.

**Car Wash Mode (Vehicle On) – Driver In Vehicle**

To place the vehicle in N (Neutral) with the vehicle on and occupied:

1. Drive to the entrance of the car wash.
2. Apply the brake pedal.

3. Shift to N (Neutral).
4. Release the brake pedal.
5. The vehicle is now ready for the car wash.

**Car Wash Mode (Vehicle On) – Driver Out of Vehicle**

To place the vehicle in N (Neutral) with the vehicle on and unoccupied:

1. Drive to the entrance of the car wash.
2. Apply the brake pedal.
3. Open the door.
4. Shift to N (Neutral). Then release the brake pedal.
5. The indicator should continue to show N. If it does not, repeat Steps 2–4.
6. Exit the vehicle and close the door. The vehicle is now ready for the car wash.
7. The vehicle may automatically shift into P (Park) upon reentry.

**D** : This position is for normal driving. If more power is needed for passing, press the accelerator pedal down.

To shift into D (Drive):

1. Bring the vehicle to a complete stop.

2. From the center position, move the shift lever back.
  - If the vehicle is in P (Park), press the shift lock release button while pulling the shift lever back.
  - D will illuminate in red.
3. After releasing the shift lever, it will return to the center position.

To shift out of D (Drive):

1. Bring the vehicle to a complete stop.
2. Shift to the desired gear.

**Caution**

Spinning the tires excessively may damage the electric drive unit. The repair will not be covered by the vehicle warranty. If you are stuck, do not spin the tires.

When stopping on a hill, use the brakes to hold the vehicle in place.

When shifting to P (Park) on a hill, use the brakes to hold the vehicle then shift to P (Park).

**L** : This position provides additional coast braking for driving downhill, towing a trailer, or hauling a heavy load

To use this feature:

1. Ensure the vehicle is in D (Drive).
2. From the center position, move the shift lever back.

After releasing the shift lever, it will return to the center position

To exit L (Low) and shift into D (Drive) or N (Neutral): At any speed, shift to D (Drive) or N (Neutral).

To exit L (Low) and shift into P (Park) or R (Reverse):

1. Bring the vehicle to a complete stop.
2. Shift to the desired gear.

Cruise control can be used while the vehicle is in L (Low) Mode.

## One-Pedal Driving

One-Pedal Driving allows the use of the accelerator pedal to control the deceleration of the vehicle to a complete stop. Completely releasing the accelerator pedal will result in aggressive deceleration. Partially lifting off the accelerator pedal allows the deceleration of the vehicle to be adjusted as desired.

Use the brake pedal if emergency braking is required.

To view and configure One-Pedal Driving, from the infotainment display home screen, select Settings, then Vehicle, and then One-Pedal Driving.

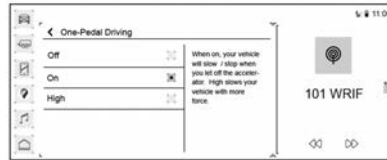

Select Off to disable One-Pedal Driving for traditional two-pedal driving, similar to a gasoline vehicle.

Select On to enable One-Pedal Driving where a moderate level of braking is applied when the accelerator pedal is released while driving.

Select High to enable One-Pedal Driving where a strong level of braking is applied when the accelerator pedal is released while driving.

When enabled, One-Pedal Driving applies in D (Drive) and L (Low). The vehicle will remain in One-Pedal Driving mode, including through vehicle off and on power cycles,

until manually disabled by the driver. Press the accelerator pedal to the desired speed. The brake lamps will come on during substantial deceleration and when the vehicle is stopped.

If One-Pedal Driving is turned off while stopped, the vehicle will stay stopped. Press the brake pedal or accelerator pedal to return to two-pedal driving.

For faster access, One-Pedal Driving can be toggled on the Driver Mode screen. Turn the driver mode knob to bring up the driver mode screen.



Touch  to toggle One-Pedal Driving on or off. When turned on, One-Pedal Driving returns to the previously selected level. To change the level, press the Settings link in the pop-up box to go to the full One-Pedal Driving selection.



When possible, One-Pedal Driving uses regenerative braking to slow the vehicle for energy efficiency. Friction brakes may be used in some cases when regenerative braking is reduced. Friction brakes will be used to hold the vehicle after coming to a stop, and a noise may be noticed when the brakes apply.

When driving on slippery roads, it is recommended to turn off One-Pedal Driving. See *Winter Driving* ⇨ 174.

For increased coast braking, shift to L (Low). See *Trailer Towing* ⇨ 266.

While using One-Pedal Driving, the Electric Parking Brake may apply in some circumstances. This can occur when:

- The driver exits the vehicle.
- The vehicle has remained stationary for five minutes.

To resume driving, press the accelerator pedal, and the Electric Parking Brake will automatically disengage.

## Drive Systems

### Four-Wheel Drive

This vehicle is equipped with advanced electric four-wheel drive (e4WD). The e4WD system delivers power to all four wheels, and the system adjusts automatically to the driving conditions. The e4WD system continuously varies the drive power to the front and rear wheels to maximize driving efficiency and improve driving dynamics. Your vehicle has exceptional driving capability, but care must always be taken to adjust driving style to the traffic and road conditions.

#### Torque Vectoring:

If equipped, the torque vectoring feature of e4WD enhances vehicle performance by biasing drive torque to the optimal wheel(s).

The vehicle e4WD settings may be customized for the driver mode selected. See *Driver Mode Control* ⇨ 194 for more information.

## Brakes

### Antilock Brake System (ABS)

The Antilock Brake System (ABS) helps prevent a braking skid and maintain steering while braking hard.



If there is a problem with ABS, this warning light stays on. See *Antilock Brake System (ABS) Warning Light* ⇨ 103.

ABS does not change the time needed to get a foot on the brake pedal and does not always decrease stopping distance. If you get too close to the vehicle ahead, there will not be enough time to apply the brakes if that vehicle suddenly slows or stops. Always leave enough room ahead to stop, even with ABS.

#### Using ABS

Do not pump the brakes. Just hold the brake pedal down firmly. Hearing and feeling ABS operate is normal.

## Braking in Emergencies

ABS allows steering and braking at the same time. In many emergencies, steering can help even more than braking.

## Electric Parking Brake



The Electric Parking Brake (EPB) can be applied when the vehicle is on or off. If there is not enough electrical power, the EPB cannot be applied or released. To prevent draining the battery, avoid unnecessary repeated cycles of the EPB.

The system has a red EPB status light and an amber service EPB warning light. See *Electric Parking Brake Light* ⇨ 103 and

*Service Electric Parking Brake Light* ⇨ 103. There are also parking brake-related Driver Information Center (DIC) messages.

Before leaving the vehicle, check the red EPB status light to ensure that the EPB is applied.

If a message displays on the DIC indicating the transmission is unable to shift, the service EPB light is on, and the EPB light flashes at the same time, the system must be reset. Start the vehicle, apply the EPB, and then release it. The message and light should turn off. See *Electric Parking Brake Light* ⇨ 103 and *Service Electric Parking Brake Light* ⇨ 103.

### EPB Apply

To apply the EPB:

1. Be sure the vehicle is at a complete stop.
2. Press the EPB switch.

The red EPB status light will flash and then stay on once the EPB is fully applied. If the red EPB status light flashes continuously, then the EPB is only partially applied or there is a problem with the EPB. A DIC message will display. Release the EPB and try to apply it again. If the light does not

come on, or keeps flashing, have the vehicle serviced. Do not drive the vehicle if the red EPB light is flashing. See your dealer.

If the amber service EPB warning light is on, press the EPB switch. Continue to hold the switch until the red EPB status light remains on. If the amber service EPB warning light is on, see your dealer.

If the EPB is applied while the vehicle is moving, the vehicle will decelerate as long as the switch is pressed. If the switch is pressed until the vehicle comes to a stop, the EPB will remain applied.

The vehicle may automatically apply the EPB in some situations when the vehicle is not moving. This is normal, and is done to periodically check the correct operation of the EPB system, or as required by other safety functions that utilize the EPB.

If the EPB fails to apply, block the rear wheels to prevent vehicle movement.

### EPB Release

To release the EPB:

1. Turn the vehicle on.
2. Apply and hold the brake pedal.
3. Press the EPB switch.

The EPB is released when the red parking brake status light is off.

If the amber service EPB warning light is on, release the EPB by pressing and holding the EPB switch. Continue to hold the switch until the red parking brake status light is off. If either light stays on after release is attempted, see your dealer.

**Caution**

Driving with the parking brake on can overheat the brake system and cause premature wear or damage to brake system parts. Make sure that the parking brake is fully released and the brake warning light is off before driving.

If you are towing a trailer and parking on a hill, see *Driving Characteristics and Towing Tips* ⇨ 263.

**Automatic EPB Release**

The EPB automatically releases if the vehicle is running, placed into gear, and an attempt is made to drive away. Avoid rapid acceleration when the EPB is applied, to preserve parking brake lining life.

**Brake Assist**

Brake Assist detects rapid brake pedal applications due to emergency braking situations and provides additional braking to activate the Antilock Brake System (ABS) if the brake pedal is not pushed hard enough to activate ABS normally. Minor noise, brake pedal pulsation, and/or pedal movement during this time may occur. Continue to apply the brake pedal as the driving situation dictates. Brake Assist disengages when the brake pedal is released.

**Hill Start Assist (HSA)**



**Warning**

Do not rely on the HSA feature. HSA does not replace the need to pay attention and drive safely. You may not hear or feel alerts or warnings provided by this system. Failure to use proper care when driving may result in injury, death, or vehicle damage. See *Defensive Driving* ⇨ 164.

When the vehicle is stopped on a grade, Hill Start Assist (HSA) prevents the vehicle from rolling in an unintended direction during the transition from brake pedal release to

accelerator pedal apply. The brakes release when the accelerator pedal is applied. If the accelerator pedal is not applied within a few minutes, the Electric Parking Brake will apply. The brakes may also release under other conditions. Do not rely on HSA to hold the vehicle.

HSA is available when the vehicle is facing uphill in a forward gear, or when facing downhill in R (Reverse). The vehicle must come to a complete stop on a grade for HSA to activate.

**Regenerative Braking**

Regenerative braking takes some of the energy from the moving vehicle and turns it back into electrical energy. This energy is then stored back into the high voltage battery system, contributing to increased energy efficiency.

Regenerative power may be limited when the battery is near full charge or cold. See “Regenerative Power Limited” under *Power Indicator Gauge* ⇨ 99. Regenerative braking supplements your vehicle’s conventional brakes, especially when going downhill. See *Hill and Mountain Roads* ⇨ 174.

**Warning**

Do not charge your vehicle's battery above an 80% charge if you are going to drive down long, steep grades such as mountain passes. This provides room in the battery for regenerative braking to supplement your conventional brakes during the descent. This is especially important when towing a trailer, which puts additional stress on your vehicle's braking system.

See "Charge Now" under *Charging* ⇨ 109 for information on setting charge limits. See *Hill and Mountain Roads* ⇨ 174 for important information about driving on grades.

The brake system uses regenerative braking, conventional hydraulic braking, or a combination of both as appropriate.

**Regen on Demand**

Regen on Demand allows increased deceleration by pressing and holding the steering wheel paddle. It works in D (Drive) and L (Low). The accelerator pedal can be used to manage deceleration while using Regen on Demand. See One-Pedal Driving.

If the vehicle is brought to a complete stop while the Regen on Demand paddle is held, the vehicle will not creep forward when the paddle is released. The accelerator pedal must be pressed to move the vehicle forward.

If the vehicle is on a steep grade, the brake pedal must be used to hold the vehicle.

When available regenerative braking power is limited, the hydraulic brakes may be applied to make up the difference.

Cruise control will turn off and the brake lamps may come on when this feature is activated.

Avoid using Regen on Demand under slippery road conditions. Use the brake pedal as the primary braking device.

**Ride Control Systems****Traction Control/Electronic Stability Control****System Operation**

The vehicle has a Traction Control System (TCS) and StabiliTrak/Electronic Stability Control (ESC) system. These systems help limit wheel slip and assist the driver in maintaining control, especially on slippery road conditions.

TCS activates if it senses that any of the drive wheels are spinning or beginning to lose traction. When this happens, TCS applies the brakes to the spinning wheels and reduces propulsion system power to limit wheel spin.

StabiliTrak/ESC activates when the vehicle senses a difference between the intended path and the direction the vehicle is actually traveling. StabiliTrak/ESC selectively applies braking pressure to any one of the vehicle wheel brakes to assist the driver in keeping the vehicle on the intended path.

If cruise control is being used and TCS or StabiliTrak/ESC begins to limit wheel spin, cruise control will disengage. Cruise control may be turned back on when road conditions allow.

Both systems come on automatically when the vehicle is started and begins to move. The systems may be heard or felt while they are operating or while performing diagnostic checks. This is normal and does not mean there is a problem with the vehicle.

It is recommended to leave both systems on for normal driving conditions, but it may be necessary to turn TCS off if the vehicle gets stuck in sand, mud, ice, or snow. See “Turning the Systems Off and On” later in this section.



The indicator light for both systems is in the instrument cluster. This light will:

- Flash when TCS is limiting wheel spin.
- Flash when StabiliTrak/ESC is activated.
- Turn on and stay on when either system is not working.

If either system fails to turn on or to activate, a message displays in the Driver Information Center (DIC), and  comes on and stays on to indicate that the system is inactive and is not assisting the driver in maintaining control. The vehicle is safe to drive, but driving should be adjusted accordingly.

If  comes on and stays on:

1. Stop the vehicle.
2. Turn the vehicle off and wait 15 seconds.
3. Start the vehicle.
4. Drive the vehicle.



If  comes on and stays on, the vehicle may need more time to diagnose the problem. If the condition persists, see your dealer.

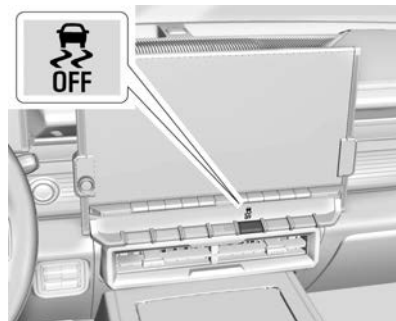

### Turning the Systems Off and On







#### Caution



Do not repeatedly brake or accelerate heavily when TCS is off. The vehicle driveline could be damaged.

To turn off only TCS, press and release . The traction off light  displays in the instrument cluster.

To turn TCS on again, press and release . The traction off light  displayed in the instrument cluster will turn off.

If TCS is limiting wheel spin when  is pressed, the system will not turn off until the wheels stop spinning.

To turn off both TCS and StabiliTrak/ESC, press and hold  until the traction off light  and StabiliTrak/ESC OFF light  come on and stay on in the instrument cluster. StabiliTrak can only be disabled below 56 km/h (35 mph) in normal mode and 90 km/h (56 mph) in Off-Road mode. ESC will automatically re-enable at 90 km/h (56 mph).

To turn TCS and StabiliTrak/ESC on again, press and release . The traction off light  and StabiliTrak/ESC OFF light  in the instrument cluster turn off.

Adding accessories can affect the vehicle performance. See *Accessories and Modifications* ⇨ 291.

## Acceleration Mode (Watts to Freedom)

The Watts to Freedom feature accelerates the vehicle rapidly on a straightaway. This mode was designed for short durations, and not intended for daily use.

Watts to Freedom will not function when the vehicle battery is low or if the vehicle is unable to lower. The vehicle height must be lowered to improve aerodynamics before the vehicle can enter this mode.

Watts to Freedom will impact the pedal map, Antilock Brake System (ABS), Traction Control System (TCS), and Electronic Stability Control (ESC) performance. Ride height, Electric Vehicle Sound Enhancement (EVSE), suspension, steering, active rear steer, electric Four-Wheel Drive (e4WD), and active braking will also be tuned for maximum performance while in the Watts to Freedom mode. While this mode is enabled, the driver will not be able to change the drive height.

Once the Acceleration mode is entered, the driver seat will vibrate throughout the different stages of the feature.

### Warning

Watts to Freedom is intended for use only on a closed course and should not be used on public roads. When this feature is activated, the vehicle lowers and accelerates rapidly. Someone could be injured or killed if struck by the vehicle, or the vehicle could be damaged. Before using this feature, make sure there are no people or objects around, under, or in the path of the vehicle.

To activate this feature:

1. Bring the vehicle to a complete stop.

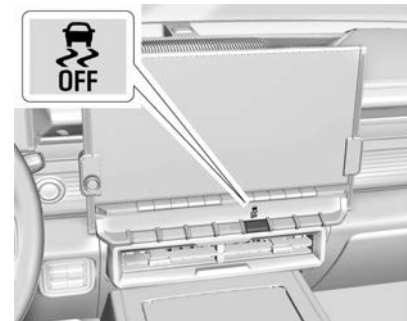

2. Press  twice on the instrument panel. A video with sound will appear on the infotainment screen. A message will display on the Driver Information Center (DIC) to confirm the lowering feature of the Watts to Freedom mode.
3. Once the vehicle lowers, the instrument cluster displays a Power Gauge Capability graphic, which increases as the vehicle begins optimizing battery temperature. The amount of time this takes depends on the outside temperatures.  
When battery optimization is complete and Watts to Freedom is ready, a message will display on the instrument cluster indicating the feature is ready.
4. Straighten the steering wheel and press and hold the brake pedal with your left foot. A “Brake Harder” message may appear on the instrument cluster.
5. The instrument cluster will display a “Floor It” message. While holding the brake pedal with your left foot, use your right foot to press the accelerator pedal to the floor.
6. When the brake and accelerator pedals are pressed the appropriate amount, the instrument cluster will display a “Release Brake to Launch” message. While your

right foot is holding the accelerator to the floor, quickly release the brake pedal to accelerate the vehicle. The vehicle will begin a rapid acceleration with greater-than-normal torque until the accelerator pedal has been released.

7. After the acceleration event, Watts to Freedom will be in standby mode until the vehicle has come to a complete stop.

The acceleration event can be repeated until the Watts to Freedom mode is exited.

#### Exiting Watts to Freedom Mode

After acceleration is complete, exit the Watts to Freedom mode. Remaining in this mode will decrease vehicle performance.

Exit the Watts to Freedom mode by selecting a new drive mode. Press  or turn the vehicle off. See *Driver Mode Control* ⇨ 194 for more information on additional modes.

#### Driver Mode Control

Driver Mode Control (DMC) allows the driver to adjust the overall driving experience by selecting different modes. If equipped, Driver Mode Control may have the following modes: Normal, Off-Road, Terrain, Tow/Haul, and a customizable mode: My Mode. Drive

mode availability and affected vehicle subsystems are dependent upon vehicle trim level, region, and optional features.

If the vehicle is in Normal mode or My Mode it will stay in that mode through future on/off cycles. If the vehicle is in any other mode, it will return to Normal mode when the vehicle is restarted. When each mode is selected, a unique and persistent indicator will be displayed on the instrument cluster.

#### Mode Activation



To activate each mode, turn the MODE knob on the center console.

## Mode Descriptions

**Normal Mode** : Use for normal city and highway driving to provide a smooth ride. This setting provides balance between comfort and handling. There is no persistent indicator in the instrument cluster for this mode.

 **Off-Road Mode** : Use this mode only for off-road recreational driving. Off-Road mode should be used to improve driving at moderate speeds, on grass, gravel, dirt, unpaved roads, or snow-covered roads. The accelerator pedal is tuned for off-road use. If equipped, this mode also modifies steering, suspension, active rear steer, electric Four-Wheel Drive (e4WD), Electric Vehicle Sound Enhancement (EVSE), Antilock Brake System (ABS), Electronic Stability Control (ESC), and Traction Control System (TCS) performance.

For more information on off-road driving, see *Off-Road Driving* ⇨ 166.

 **Tow/Haul Mode** : Use this mode when hauling heavy loads to provide increased performance and vehicle control. Tow/Haul Mode adjusts the pedal map, steering, active rear steer, suspension, and TSC performance.

If the vehicle is turned off with Tow/Haul mode active and then restarted within four hours or less Tow/Haul will remain active. Otherwise, the vehicle will start in Normal mode.

For more information on Tow/Haul mode, see *Towing Equipment* ⇨ 270.

 **Terrain Mode** : Use this mode when traveling on very rough roads at very low speeds, such as a two-track or heavily rutted road where precise vehicle control is required. This can also be used for pulling a boat out of the water on a trailer.

When in Terrain mode, the vehicle maximizes torque for better control at lower speeds and over rough terrain. This mode modifies accelerator pedal mapping, ABS and TCS performance, EVSE, suspension, steering, active rear steer, e4WD, and active braking. Speed is limited to 80 km/h (50 mph) while in Terrain mode.

When the vehicle comes to a stop on an upward grade, Terrain mode will hold the vehicle stationary until the driver presses the accelerator pedal. Cruise control is disabled when in Terrain mode.

Terrain mode automatically exits to Normal Mode if the brake temperatures become too hot, electronic parking brake becomes inoperable, or the vehicle cannot perform braking or vehicle hold.

Active Braking engages when the driver lifts their foot off the accelerator while in Terrain mode. This feature applies light braking in D (Drive) and aggressive braking in L (Low) in order to tailor the level of vehicle control to the driver's preference.

For more information on off-road driving, see *Off-Road Driving* ⇨ 166 and *Hill and Mountain Roads* ⇨ 174.

 **My Mode** : My Mode is used to personalize everyday driving. This mode allows the driver to configure the driver systems to their driving preferences. If available, this mode modifies electric vehicle pedal map, steering, suspension, and sound performance. My Mode will remain active across on/off cycles.

Through the infotainment display, the following vehicle sub-systems may be available for customization in this mode:

**Acceleration** : Relaxed, Normal, Adrenaline

**Steering** : Normal, Tow/Haul, Terrain



**Suspension** : Normal, Off Road, Terrain

**Motor Sound** : Relaxed, Normal, Adrenaline

For a more detailed description of each selectable option, refer to “Drive Mode Customization” later in this section.

**Watts to Freedom** : Watts to Freedom provides maximum straight-line acceleration of the vehicle. Engaging Watts to Freedom will override and exit the current mode the vehicle is using.

For a more detailed description of Watts to Freedom, refer to *Acceleration Mode (Watts to Freedom)* ⇨ 193.

### Drive Mode Customization

The vehicle is equipped to modify the following settings based on vehicle content. Through the center radio display, under “Vehicle Settings”, select “Drive Mode Customization” to customize and personalize My mode. These settings will be retained over each on/off cycle, and do not have to be reset each time the vehicle is started.

**Motor Sound** : Customize how the vehicle sounds when accelerating. The electric motor will remain quiet outside but the sound heard inside will change as vehicle is driven faster or slower.

**Steering** : Choose how responsive you want the steering to feel. You can set the steering wheel to provide more feedback, which requires more steering effort.

**Suspension** : Choose how responsive you want the suspension to feel. You can make the suspension stiffer or more comfortable.

**Acceleration** : Choose how responsive you want the acceleration to feel. You can adjust the accelerator pedal to provide increased power.

### Four-Wheel Steering (Including Crabwalk)

If equipped, this feature steers the vehicle with all four wheels, which reduces the vehicle turn diameter and improves maneuverability of the vehicle.

The four-wheel steering feature has three modes: Automatic, CrabWalk, and Off.

**Automatic Mode** : The default mode at vehicle start up. It is recommended to stay in Automatic Mode for everyday driving at all times, and during all weather conditions. The Automatic Mode can be selected at any time.

If the Automatic Mode is selected when the vehicle is in the process of turning, the mode will not engage until the turn is complete.

**CrabWalk Mode** : Allows the driver to turn the rear wheels at the same angle as the front wheels enabling the vehicle to move diagonally.

**Off Mode** : Disengages the four-wheel steering feature. The vehicle will be steered with the front wheels and the rear wheels will be in the forward position.

At slower speeds the front and rear wheels will turn in opposite directions (except in the CrabWalk Mode). This helps the vehicle make tighter turns, such as during parking, cornering and turning into tight spaces. At higher speeds the front and rear wheels will turn in the same direction. This improves stability of the vehicle during lane changes and wide turns

When the vehicle is shut-off, the rear steering angle will automatically return to the forward position.

When the vehicle is stationary, the full 10 degrees of rear steering angle may not be available until the vehicle begins to move.

Four-wheel steering is not operational when Super Cruise is active. See *Super Cruise* ⇨ 213.

Maximum vehicle speed may be limited if the four-wheel steering system becomes inoperable.

When towing a trailer the four-wheel steering provides enhanced stability allowing the trailer to follow the path of the tow vehicle more closely, especially during lane changes. See *General Towing Information* ⇨ 262 for more information on towing a trailer.

### Driver Notification

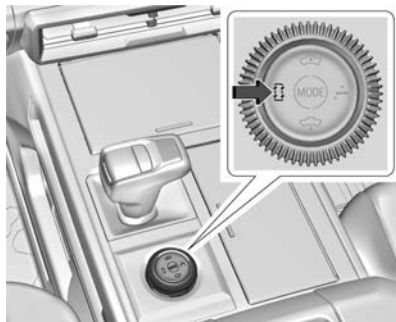

The four-wheel steering button is on the Driver Mode Control rotary switch on the center console behind the shift lever.

If CrabWalk Mode or Off Mode is activated, an icon on the Driver Information Center (DIC) will turn on and stay on. If the Automatic Mode is activated, no icon will display.

The following icons will display depending on the mode activated:



CrabWalk Mode



Off Mode

The following three second pop-up messages will display on the DIC when the four-wheel steering mode changes:

- Rear Wheel Steering – AUTO
- Rear Wheel Steering – CRABWALK
- Rear Wheel Steering – OFF

### How to Enter Automatic Mode

- Automatic Mode is the default four-wheel steering mode at vehicle key-up.

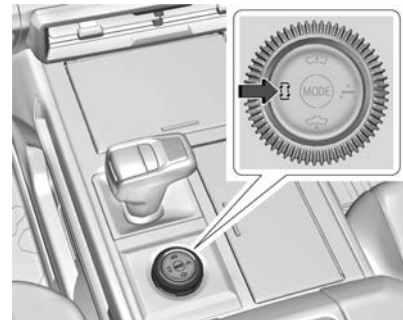

- Tap the four-wheel steering button while in Off Mode or CrabWalk Mode to return to the Automatic Mode.

### Steering Behavior in Automatic Mode

- Four-wheel steering is based on front steering angle.
  - At lower vehicle speeds less than 40 km/h (25 mph) the rear wheels steer opposite of the front wheels to improve turning radius.
  - At higher vehicle speed more than 40 km/h (25 mph) the rear wheels steer in same direction as the front wheels to improve handling stability.

- The exact relationship of front to rear angle is dependent on the currently selected Driver Mode Control Mode.

### How to Enter CrabWalk Mode

- The following vehicle conditions must be true to enter CrabWalk Mode:
  - Vehicle speed less than 2 km/h (1.2 mph)
  - The vehicle is in P (Park) or N (Neutral)
  - Steering wheel not in motion
  - CrabWalk Mode can not be engaged while Super Cruise is active

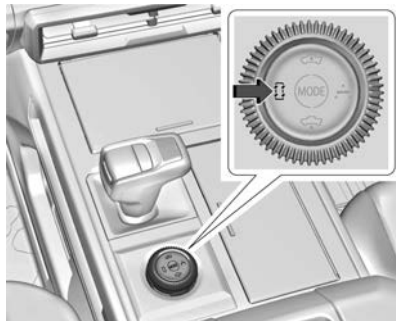

- Press and hold the four-wheel steering button continuously for four seconds while in Off Mode or Automatic Mode.

- The CrabWalk icon will begin flashing after the four-wheel steering button is held continuously for one second indicating that CrabWalk Mode engagement is now in process.
- Animation in the center stack will indicate when the switch can be released, which will then activate CrabWalk Mode.
- If button is held continuously for more than 10 seconds, CrabWalk Mode will NOT activate.

### How to Exit CrabWalk Mode

1. The steering wheel must be center and not in motion when exiting CrabWalk Mode.
2. Tap the four-wheel steering button to exit back to the Automatic Mode.

If the vehicle speed reaches higher than about 40 km/h (25 mph) for more than 10 seconds, the vehicle will automatically exit CrabWalk mode and turn on Automatic mode.

### CrabWalk Mode Steering Behavior

- Rear wheels steer in the same direction as front wheels at lower vehicle speeds less than 32 km/h (20 mph).

- Maximum rear steering angle in CrabWalk Mode is 10 degrees (equivalent to front steering wheel angle of 180 degrees).
- Intended to improve maneuverability for specific off road situations.

### How to Enter Off Mode

- The following vehicle conditions must be true to enter the Off Mode:
  - Vehicle speed less than 2 km/h (1.2 mph)
  - The vehicle is in P (Park) or N (Neutral)
  - Steering wheel is not in motion
  - Off Mode can not be engaged while Super Cruise is active

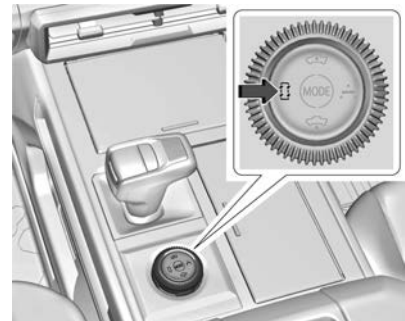

- Tap the four-wheel steering button while in Automatic Mode or CrabWalk Mode to enter.

#### How to Exit Off Mode

1. The steering wheel cannot be in motion when exiting Off Mode.
2. Tap the four-wheel steering button to exit back to the Automatic Mode.

#### Steering Behavior in Off Mode

Four-wheel steering is disengaged with rear wheels set to forward position.

#### Four-Wheel Steering Behavior at 0 MPH

The rear wheels may not steer to full travel when the vehicle is stationary. Additional travel may be achieved once the vehicle begins to move.

Care should be taken to ensure the vehicle path is clear of obstacles if the rear tires steer once the vehicle is moving.

#### Locking Rear Axle

If equipped, the locking rear axle can give the vehicle additional traction from the rear wheels when traveling in off-road situations such as mud, snow, steep hills, and uneven terrain.

#### Caution

If you try to lock the axle while the vehicle is stuck and the tires are spinning, the vehicle's drivetrain could be damaged. The repairs would not be covered by the vehicle warranty. Always lock the axle before attempting situations and/or navigating terrain that could cause the vehicle to become stuck.

#### Caution

If the vehicle's axle is locked while driving on pavement, the drivetrain could be damaged. Repairs would not be covered by the vehicle warranty. Do not use the locking axle on pavement.

To lock the rear axle:

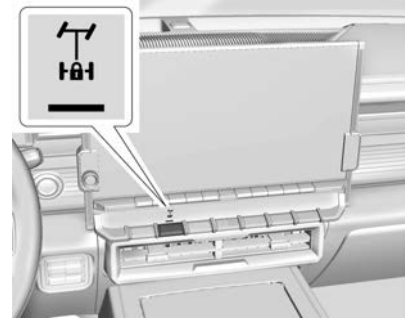

1. Press the rear axle locking switch. The vehicle must be moving 40 km/h (25 mph) or less.
2. Wait for the light on the switch to stop flashing. A solid light indicates the rear axle is locked.

When the vehicle speed exceeds 40 km/h (25 mph) the locking rear axle disengages. The Off-Road Mode and Terrain Mode allow the axle lock to remain engaged at higher vehicle speeds.

After pressing the switch to unlock the axle, it may remain locked due to torque in the driveline. To quickly unlock the axle, turn the steering wheel to the right and to the left while traveling at a low speed.

## Locking Front Axle

If equipped, the locking front axle can give the vehicle additional traction when traveling in off-road situations such as mud, snow, steep hills, and uneven terrain. The locking front axle must not be used on high traction surfaces such as pavement.

### Caution

If you try to lock the axle while the vehicle is stuck and the tires are spinning, the vehicle's drivetrain could be damaged. The repairs would not be covered by the vehicle warranty. Always lock the axle before attempting situations and/or navigating terrain that could cause the vehicle to become stuck.

### Caution

If the vehicle's axle is locked while driving on pavement, the drivetrain, suspension, and steering systems could be damaged. Repairs would not be covered by the vehicle warranty. Do not use the locking axle on pavement.

### Warning

Driving on pavement with a locked front axle may cause reduction to or complete loss of steering assist, which could result in serious injury, death, or property damage. Do not use the locking front axle on pavement.

Before the front axle can be locked, the vehicle must be in Terrain mode. See "Terrain Mode" under *Driver Mode Control* ⇨ 194. If it was not already locked, the rear axle will lock first followed by the front axle.

To lock the front axle:

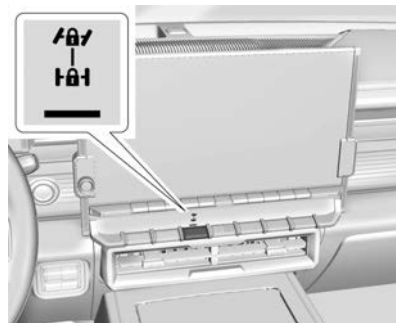

1. Press the front/rear axle locking switch and hold for five seconds. The vehicle must be stopped or moving less than 24 km/h (15 mph).
2. After releasing the front/rear axle locking switch, a solid light on the switch displays to indicate the front axle is locked. The front axle lock disables the Antilock Brake System (ABS) and illuminates the ABS warning light.

To unlock the front axle:

1. Press the rear axle locking switch. The front axle unlocks and the rear axle remains locked. See *Locking Rear Axle* ⇨ 199.

2. Press the front/rear axle locking switch.  
The front and rear axles both unlock.

The locking front axle disengages automatically when the vehicle speed exceeds 24 km/h (15 mph) or Terrain mode is exited.

ABS automatically enables and the ABS warning light turns off when the locking front axle disengages.

After pressing the switch to unlock the axle, in rare circumstances, it may remain locked due to torque in the driveline. To quickly unlock the axle, turn the steering wheel to the right and to the left while traveling at a low speed.

## Air Suspension

The Air Suspension feature provides full time load leveling capability along with the benefit of adjusting ride height for increased convenience and capability.

### Warning

To help avoid personal injury or death, make sure the area underneath the vehicle and inside the wheel wells is clear when lowering the vehicle.

### Warning

To help avoid personal injury or death, always select the lowest ride height for the current driving conditions. Higher ride heights raise the vehicle's center of gravity, increasing the chance of a rollover during extreme maneuvers.

### Warning

Heavy loads on the roof rack will make the vehicle's center of gravity higher, increasing the possibility of a rollover. To avoid losing control of the vehicle, always select the normal height setting and avoid high speeds, sudden starts, sharp turns, sudden braking, or abrupt maneuvers when carrying cargo on the roof rack.

## Changing Ride Height

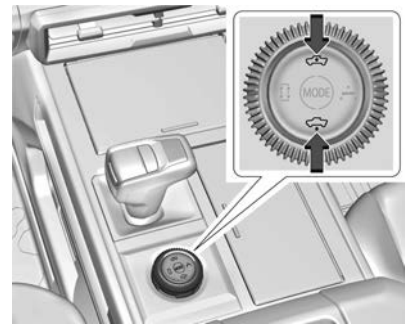

Press either “Up” or “Down” Ride Height button to open the Ride Height menu. Select the desired ride height from the following options. After a brief pause, the menu will timeout and the selection will finalize. Ride heights that are unavailable for selection will be greyed out in the menu.

## Ride Height Descriptions

### Normal

Normal height is the standard vehicle height used for everyday driving.

### Entry/Exit

Entry/Exit height is 50 mm (2 in) lower than Normal height. This ride height lowers the vehicle for easy entry and exit, and loading and unloading of cargo.

This ride height can be selected in the Ride Height Menu at any vehicle speed; but will not lower until the vehicle slows to less than 15 km/h (9 mph).

If a door is opened after lowering to Entry/Exit height, the vehicle automatically raises to Normal height from Entry/Exit height when speed increases above 16 km/h (10 mph). If no door is opened after lowering to Entry/Exit Height, the vehicle waits to raise to Normal height until the speed increases above 30 km/h (19 mph). This gives the driver more flexibility when lowering to Entry/Exit height for passenger pick up and drop off.

The driver can enable Easy Exit Vehicle Height Mode to automatically lower to Entry/Exit Height when the vehicle is shifted to P (Park). Easy Exit Vehicle Height Mode may be enabled via the infotainment screen under Settings > Vehicle > Ride Height. When the vehicle is higher than Normal height, Easy Exit Vehicle Height Mode is disabled. When the vehicle is in Tow/Haul

Mode, Off-Road Mode, Terrain Mode, or it senses a trailer is connected, Easy Exit Vehicle Height Mode is disabled.

### Increased

Increased height is 46 mm (2 in) higher than Normal height. This ride height raises the vehicle for off-road use. Increased height can be selected in the Ride Height Menu while vehicle speed is less than 80 km/h (50 mph).

### Extract Mode

If equipped and enabled, prior to selecting Extract Mode in the Ride Height menu, ensure the vehicle speed is less than 20 km/h (12 mph), the vehicle is in Terrain mode, and the steering wheel is centered.

Extract Mode raises the vehicle to the maximum ride height, up to 149 mm (5.9 inches) higher than the Normal height. Vehicle loading, road surface, and starting ride height may affect the maximum ride height and time it takes to raise the vehicle. To ensure that the vehicle reaches its highest ride height, it is recommended to enable Extract Mode prior to reaching an obstacle where additional ground clearance is necessary.

When Extract Mode is activated, the vehicle speed is restricted to 20 km/h (12 mph). Extract Mode is intended only for additional ground clearance in off-road use. The speed restriction is removed when the ride height returns below Increased height.

If an unsafe condition is detected, the air suspension may automatically exit Extract Mode and lower the vehicle.

If the selection of Extract Mode displays LEVELING SYSTEM UNAVAILABLE on the Driver Information Center (DIC), the air springs may be at the maximum height or the Air Suspension System may need to cool down. See the “System Over-Temperature” section below for more information.

### Aerodynamic Height

Aerodynamic height is 25 mm (1 in) lower than Normal height. This ride height lowers the vehicle at higher vehicle speeds to improve aerodynamics.

The vehicle will lower to Aerodynamic height when vehicle speed exceeds 137 km/h (65 mph) for a period of time. The vehicle will raise to Normal height when the vehicle slows to less than 48 km/h (30 mph).

Aerodynamic height is automatically disabled when a trailer is connected to the vehicle, Tow/Haul mode is active, or the vehicle is at Increased Height.

### Suspension Modes

The air suspension has two special modes, Service Mode and Alignment Mode, located in the infotainment screen under Settings > Vehicle > Suspension.

### Service Mode

Service Mode will disable all air suspension operation including raising and lowering the vehicle and operation of the air compressor. This mode is useful when the vehicle is being towed on a flat bed or when any work under the vehicle is being performed.

Service Mode is recommended when the vehicle is put on a hoist or a floor jack is used to raise a corner. Service Mode automatically disables when vehicle speed exceeds 32 km/h (20 mph).

### Alignment Mode

Alignment Mode will optimize the vehicle height to provide the most accurate wheel alignment. This mode should be enabled once the vehicle is driven onto the alignment station.

To enable Alignment Mode, ensure the vehicle is at Normal Height and shift the vehicle to N (Neutral). Alignment Mode automatically disables when vehicle speed exceeds 16 km/h (10 mph).

### Air Suspension Operation with Door(s) or Hood Open

The air suspension will temporarily suspend all height changes while the hood or any door is open.

### System Over-Temperature

If the air suspension is under heavy use, the system may temporarily suspend all height changes to allow the compressor to cool down. When this occurs and a height change is requested, the message LEVELING SYSTEM UNAVAILABLE will display in the instrument cluster.

### Air Suspension Service

If a SERVICE LEVELING SYSTEM message displays in the instrument cluster, see your authorized dealer immediately.

## Cruise Control

### Adaptive Cruise Control (Advanced)

Adaptive Cruise Control (ACC) allows the cruise control set speed and following gap to be selected. Read this entire section before using this system. The following gap is the following time (or distance) between your vehicle and a vehicle detected directly ahead in your path, moving in the same direction. If no vehicle is detected in your path, ACC works like regular cruise control. ACC uses a camera and radar sensor(s) to detect other vehicles. See *Radio Frequency Statement* ⇨ 374.

If a vehicle is detected in your path, ACC can apply acceleration or limited, moderate braking to maintain the selected following gap. To disengage ACC, apply the brake. If ACC is controlling the vehicle speed when the Traction Control System (TCS) or StabiliTrak/Electronic Stability Control (ESC) system activates, ACC may automatically disengage. See *Traction Control/Electronic Stability Control* ⇨ 191. When road conditions allow ACC to be safely used, ACC can be turned back on.



Disabling the TCS or StabiliTrak/ESC system will disengage and prevent engagement of ACC.

ACC can reduce the need for you to frequently brake and accelerate, especially when used on expressways, freeways, and interstate highways. When used on other roads, you may need to take over the control of braking or acceleration more often.

### Warning

ACC has limited braking ability and may not have time to slow the vehicle down enough to avoid a collision with another vehicle you are following. This can occur when vehicles suddenly slow or stop ahead, or enter your lane. Also see “Alerting the Driver” later in this section. Complete attention is always required while driving and you should be ready to take action and apply the brakes. See *Defensive Driving* ⇨ 164.

### Warning

ACC will not detect or brake for children, pedestrians, animals, or other objects.

Do not use ACC when:

- On winding and hilly roads or when the sensors are blocked by snow, ice, or dirt. The system may not detect a vehicle ahead. Keep the entire front of the vehicle clean.
- Visibility is poor due to rain, snow, fog, dirt, insect residue, or dust; when other foreign objects obscure the camera and/or radar; or when the vehicle in front or oncoming traffic causes additional environmental obstructions, such as road spray. ACC performance is limited under these conditions.
- On slippery roads where fast changes in tire traction can cause excessive wheel slip.

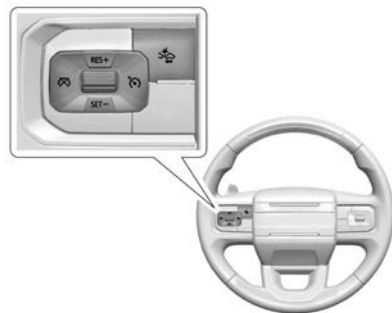

 : Press to turn the system on or off. The indicator turns white on the instrument cluster when ACC is turned on.

**RES+** : Press briefly to resume the previous set speed or to increase vehicle speed if ACC is already activated. To increase speed by about 1 km/h (1 mph), press RES+ briefly. To increase speed to the next 5 km/h (5 mph) mark on the speedometer, hold RES+.

**SET-** : Press briefly to set the speed and activate ACC or to decrease vehicle speed if ACC is already activated. To decrease speed by about 1 km/h (1 mph), press SET- briefly. To decrease speed to the next 5 km/h (5 mph) mark on the speedometer, hold SET-.

 : Press to disengage ACC without erasing the selected set speed.

 : Press to select a following gap setting for ACC of Far, Medium, or Near.

The speedometer reading can be displayed in either English or metric units. See *Instrument Cluster* ⇨ 94. The increment value used depends on the units displayed.

**Switching Between ACC and Regular Cruise Control**

To switch between ACC and regular cruise control, press and hold . A Driver Information Center (DIC) message displays. See *Vehicle Messages* ⇨ 118.



ACC Indicator

Regular Cruise Control Indicator

When ACC is activated, a green  indicator will be lit on the instrument cluster and the following gap will be displayed. When the regular cruise control is activated,



a green  indicator will be lit on the instrument cluster; the following gap will not display.

When the vehicle is turned on, the cruise control mode will be set to the last mode used before the vehicle was turned off.

 **Warning**

Always check the cruise control indicator on the instrument cluster to determine which mode cruise control is in before using the feature. If ACC is not active, the vehicle will not automatically brake for other vehicles, which could cause a crash if the brakes are not applied manually. You and others could be seriously injured or killed.

**Setting Adaptive Cruise Control**

If  is on when not in use, it could get pressed and go into ACC when not desired. Keep  off when cruise is not being used.

Select the set speed desired for ACC. This is the vehicle speed when no vehicle is detected in your path.

While the vehicle is moving, ACC will not set at a speed below a minimum speed, although it can be resumed. If equipped with Super Cruise, this minimum speed is 5 km/h (3 mph), otherwise it is 25 km/h (15 mph). The minimum allowable set speed is 15 mph.

To set ACC while moving:

1. Press .
2. Get up to the desired speed.
3. Press and release SET-.
4. Remove foot from the accelerator pedal.

After ACC is set, it may immediately apply the brakes if a vehicle ahead is detected closer than the selected following gap.

ACC can also be set while the vehicle is stopped if ACC is on and the brake pedal is applied.



The ACC indicator displays on the instrument cluster. When ACC is turned on, the indicator will be lit white. When ACC is engaged, the indicator will be lit green.

Be mindful of speed limits, surrounding traffic speeds, and weather conditions when selecting the set speed.

### **Resuming a Set Speed**

If the ACC is set at a desired speed and then the brakes are applied, ACC is disengaged without erasing the set speed from memory.

To begin using ACC again, press RES+ up briefly.

- If the vehicle is moving more than 5 km/h (3 mph), it returns to the previous set speed.
- If the vehicle is stopped with the brake pedal applied, press RES+ and release the brake pedal. ACC will hold the vehicle until RES+ or the accelerator pedal is pressed.

A green ACC indicator and the set speed display on the instrument cluster. The vehicle ahead indicator may be flashing if a vehicle ahead was present and moved. See “Approaching and Following a Vehicle” later in this section.

Once ACC has resumed, the vehicle speed will increase to the set speed under the following conditions:

- There is no vehicle ahead.
- The vehicle ahead is beyond the selected following gap.
- The vehicle speed is not being limited because of a sharp turn.

### **Increasing Speed While ACC Is at a Set Speed**

If ACC is already activated, do one of the following:

- Use the accelerator to get to the higher speed. Briefly press and release SET– and release the accelerator pedal. The vehicle will now cruise at the higher speed. When the accelerator pedal is pressed, ACC will not brake because it is overridden. While overridden, the ACC indicator will turn blue on the instrument cluster.
- Press and hold RES+ until the desired set speed is displayed, then release it.
- To increase vehicle speed in smaller increments, press RES+ briefly. For each press, the vehicle goes about 1 km/h (1 mph) faster.

- To increase vehicle speed in larger increments, hold RES+. While holding RES+, the vehicle speed increases to the next 5 km/h (5 mph) step, then continues to increase by 5 km/h (5 mph) at a time.

The set speed can also be increased while the vehicle is stopped.

- If stopped with the brake pedal applied, press RES+ until the desired set speed is displayed.
- If ACC is holding the vehicle at a stop and there is another vehicle directly ahead, pressing RES+ will increase the set speed.
- Pressing RES+ when there is no longer a vehicle ahead or the vehicle ahead is pulling away and the brake is not applied will cause the ACC to resume.

When it is determined that there is no vehicle ahead or the vehicle ahead is beyond the selected following gap, then the vehicle speed will increase to the set speed.

### **Reducing Speed While ACC Is at a Set Speed**

If ACC is already activated, do one of the following:

- Use the brake to get to the desired lower speed. Release the brake and press SET–. The vehicle will now cruise at the lower speed.

- Press and hold SET- until the desired lower speed is reached, then release it.
- To decrease the vehicle speed in smaller increments, press SET- down briefly. For each press, the vehicle goes about 1 km/h or (1 mph) slower.
- To decrease the vehicle speed in larger increments, hold SET-. While holding SET-, the vehicle speed decreases to the next 5 km/h (5 mph) step, then continues to decrease by 5 km/h (5 mph) at a time.

The set speed can also be decreased while the vehicle is stopped.

- If stopped with the brake applied, press or hold SET- until the desired set speed is displayed.

### Selecting the Follow Distance Gap

When a slower moving vehicle is detected ahead within the selected following gap, ACC will adjust the vehicle's speed and attempt to maintain the follow distance gap selected.

Press  on the steering wheel to adjust the following gap. Each press cycles the gap button through three settings: Far, Medium, or Near.

When pressed, the current gap setting displays briefly on the instrument cluster. The gap setting will be maintained until it is changed.

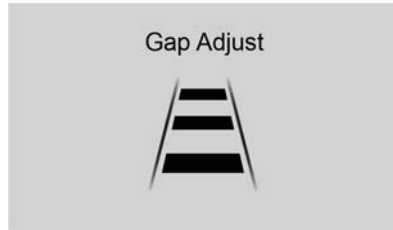

Far Gap Setting

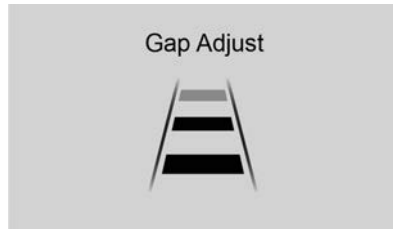

Medium Gap Setting

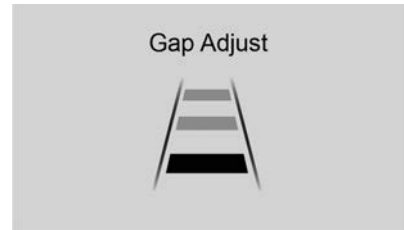

Near Gap Setting

If equipped, and a trailer is electrically connected, the gap setting display will be as follows:

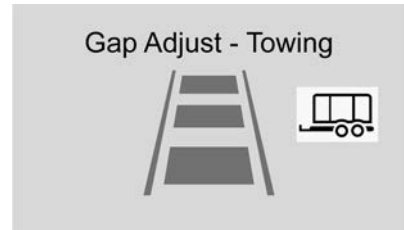

Far Gap Setting with Trailer

### Gap Adjust - Towing



Medium Gap Setting with Trailer

### Gap Adjust - Towing



Near Gap Setting with Trailer

Since each gap setting corresponds to a following time (Far, Medium, or Near), the following distance will vary based on vehicle speed. The faster the vehicle speed, the further back your vehicle will follow a vehicle detected ahead. Consider traffic and weather conditions when selecting the

following gap. The range of selectable gaps may not be appropriate for all drivers and driving conditions.

Changing the gap setting automatically changes the alert timing sensitivity (Far, Medium, or Near) for the Forward Collision Alert (FCA) feature. See *Forward Collision Alert (FCA) System* ⇨ 243.

### Courtesy Gap

Press and hold  on the steering wheel when vehicle is moving to temporarily increase the gap with the vehicle ahead to allow for merging traffic.

Press and hold  when stopped to cancel ACC from resuming automatically (if the stop is brief) and remain stationary. This can be used to allow traffic to merge between you and the vehicle ahead. Press RES+ or the accelerator pedal to resume ACC.

Following distance gap will return to the original selection after hold.

### Alerting the Driver



If ACC is engaged, driver action may be required when ACC cannot apply sufficient braking because of approaching a vehicle too rapidly.

When this condition occurs, the collision alert symbol will flash on the windshield. Either eight beeps will sound from the front, or both sides of the Safety Alert Seat will pulse five times. To view available settings from the infotainment screen, touch Settings > Vehicle > Collision/Detection Systems.

See *Defensive Driving* ⇨ 164.

### Approaching and Following a Vehicle



The vehicle ahead indicator is in the instrument cluster. It only displays when a vehicle is detected in your vehicle's path moving in the same direction. If this symbol is not displaying, ACC will not respond to or brake for vehicles ahead.

ACC automatically slows the vehicle down and adjusts vehicle speed to follow a detected vehicle ahead at the selected following gap. The vehicle speed increases or decreases to follow a detected vehicle in front of your vehicle when that vehicle is traveling slower than your vehicle set speed. It may apply limited braking, if necessary. When braking is active, the brake lamps will come on. The automatic braking may feel or sound different than if the brakes were applied manually. This is normal.

#### Passing a Vehicle While Using ACC

If the set speed is high enough, and the left turn signal is used to pass a vehicle ahead in the selected following gap, ACC may assist by gradually accelerating the vehicle prior to the lane change.

#### Warning

When using ACC to pass a vehicle or perform a lane change, the following distance to the vehicle being passed may be reduced. ACC may not apply sufficient acceleration or braking when passing a vehicle or performing a lane change. Always be ready to manually accelerate or brake to complete the pass or lane change.

#### Stationary or Very Slow-Moving Objects

#### Warning

ACC may not detect and react to stopped or slow-moving vehicles ahead of you. For example, the system may not brake for a vehicle it has never detected moving. This can occur in stop-and-go traffic or when a vehicle suddenly appears due to a vehicle ahead changing lanes. Your vehicle may not stop and could cause a crash. Use caution when using ACC. Your complete attention is always required while driving and you should be ready to take action and apply the brakes.

#### Irregular Objects Affecting ACC

ACC may have difficulty detecting the following objects:

- Vehicles with cargo extending from the back end.
- Non-standard shaped vehicles, such as vehicle transport, vehicles with a side car fitted, or horse carriages.
- Objects that are close to the front of your vehicle.

#### ACC Automatically Disengages

ACC may automatically disengage and the driver will need to manually apply the brakes to slow the vehicle if:

- The sensors are blocked.
- The Traction Control System (TCS) or StabiliTrak/ESC system has activated or been disabled.
- If equipped with Air Suspension, the vehicle ride height is outside normal operating range. See *Air Suspension* ⇨ 207.
- There is a fault in the system.
- The radar falsely reports blockage when driving in a desert or remote area with no other vehicles or roadside objects.

- A DIC message may display to indicate that ACC is temporarily unavailable.

The ACC indicator will turn white when ACC is no longer active.

In some cases, when ACC is temporarily unavailable, regular cruise control may be used. See “Switching Between ACC and Regular Cruise Control” previously in this section. Always consider driving conditions before using either cruise control system.

### Notification to Resume ACC

ACC will maintain a follow gap behind a detected vehicle and slow your vehicle to a stop behind that vehicle.

If the stopped vehicle ahead has driven away and ACC has not resumed, the vehicle ahead indicator will flash as a reminder to check traffic ahead before proceeding. In addition, the left and right sides of the Safety Alert Seat will pulse three times, or three beeps will sound. To view available settings from the infotainment screen, touch Settings > Vehicle > Collision/Detection Systems > Alert Type > Adaptive Cruise Go Notifier.

If equipped with Driver Attention System (DAS) located on top of the steering column, when the vehicle ahead drives away, and

DAS determines if the driver's attention is on the road ahead, ACC resumes automatically. See “Attention to the Road” in the *Super Cruise* ⇨ 213 section. If necessary, press RES+ or the accelerator pedal to resume ACC. If stopped for more than two minutes or if the driver door is opened and the driver seat belt is unbuckled, the ACC automatically applies the Electric Parking Brake (EPB) to hold the vehicle. The EPB status light will turn on. See *Electric Parking Brake* ⇨ 189. To release the EPB, press the accelerator pedal.

A DIC warning message may display indicating to shift to P (Park) before exiting the vehicle. See *Vehicle Messages* ⇨ 118.

### Warning

If ACC has stopped the vehicle, and if ACC is disengaged, turned off, or canceled, the vehicle will no longer be held at a stop. The vehicle can move. When ACC is holding the vehicle at a stop, always be prepared to manually apply the brakes.

### Warning

Leaving the vehicle without placing it in P (Park) can be dangerous. Do not leave the vehicle while it is being held at a stop by ACC. Always place the vehicle in P (Park) and turn it off before leaving the vehicle.

### ACC Override

If using the accelerator pedal while ACC is active, the ACC indicator turns blue on the instrument cluster indicating ACC braking will not occur. ACC will resume operation when the accelerator pedal is not being pressed.

### Warning

The ACC will not automatically apply the brakes if your foot is resting on the accelerator pedal. You could crash into a vehicle ahead of you.

## Curves in the Road

### Warning

On curves, ACC may not detect a vehicle ahead in your lane. You could be startled if the vehicle accelerates up to the set speed, especially when following a vehicle exiting or entering exit ramps. You could lose control of the vehicle or crash. Do not use ACC while driving on an entrance or exit ramp. Always be ready to use the brakes if necessary.

### Warning

On curves, ACC may respond to a vehicle in another lane, or may not have time to react to a vehicle in your lane. You could crash into a vehicle ahead of you, or lose control of your vehicle. Give extra attention in curves and be ready to use the brakes if necessary. Select an appropriate speed while driving in curves.

ACC may operate differently in a sharp curve. It may briefly reduce the vehicle speed if the curve is too sharp.

The curve speed control indicator  may illuminate green when ACC is actively controlling the vehicle speed and detects a sharp curve on the road ahead.

ACC automatically slows the vehicle down while navigating the curve and may increase speed out of the curve, but will not exceed the set speed.

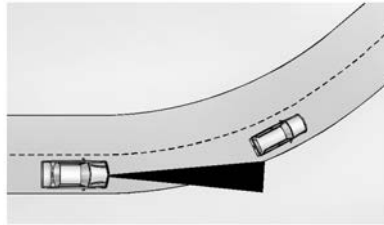

When following a vehicle and entering a curve, ACC may not detect the vehicle ahead and accelerate to the set speed. When this happens, the vehicle ahead indicator will not appear.

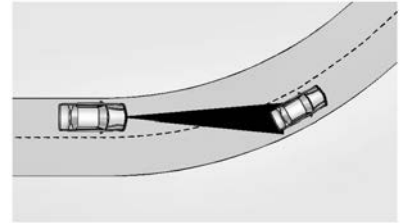

ACC may detect a vehicle that is not in your lane and apply the brakes.

ACC may occasionally provide an alert and/or braking that is considered unnecessary. It could respond to vehicles in different lanes or stationary objects when entering or exiting a curve. This is normal operation. The vehicle does not need service.

### Other Vehicle Lane Changes

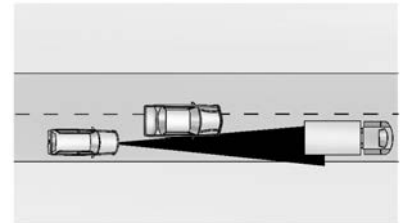



ACC will not detect a vehicle ahead until it is completely in the lane. The brakes may need to be manually applied.

### **Objects Not Directly in Front of Your Vehicle**

The detection of objects in front of the vehicle may not be possible if:

- The vehicle or object ahead is not within your lane.
- The vehicle ahead is shifted, not centered, or is shifted to one side of the lane.

### **Driving in Narrow Lanes**

Vehicles in adjacent traffic lanes or roadside objects may be incorrectly detected when located along the roadway.

### **Do Not Use ACC on Hills**

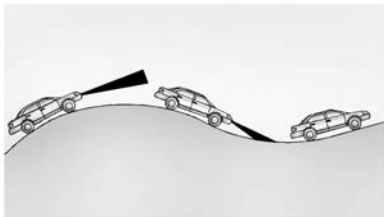

Do not use ACC when driving on steep hills. ACC will not detect a vehicle ahead.

### **Towing with ACC**

If equipped when towing a trailer, ACC driving characteristics such as following gap, acceleration rates and braking rates may be modified to provide a better towing experience.

When ACC is used with vehicles equipped with aftermarket trailer brake controller, disengage ACC before applying the manual trailer brake. ACC will not automatically disengage when manual trailer brake is applied.



ACC may be used when towing a trailer when trailer attached is within GM-approved allowable size and weight limits. See *Trailer Towing* ⇨ 266.

When towing a trailer with ACC, it is important to properly set the Trailer Gain. See “Integrated Trailer Brake Control System” in *Towing Equipment* ⇨ 270 for Trailer Gain Adjustment Procedure.

Use Tow/Haul mode when driving down steep hills or mountain grades, or when hauling heavy loads. See *Driver Mode Control* ⇨ 194.

### **Disengaging ACC**

There are four ways to disengage ACC:

- Step lightly on the brake pedal.
- Press .
- Press .
- Press the Regen On Demand paddle.

### **Erasing Speed Memory**

The ACC set speed is erased from memory if  is pressed or if the vehicle is turned off.

### **Weather Conditions Affecting ACC**

System operation may be limited under snow, heavy rain, or road spray conditions.

### **Accessory Installations and Vehicle Modifications**

Do not install or place any object around the front camera windshield area that would obstruct the front camera view.

Do not install objects on top of the vehicle that overhang and obstruct the front camera, such as a canoe, kayak, or other items that can be transported.

Do not modify the hood, headlamps, or fog lamps, as this may limit the camera’s ability to detect an object.

## Cleaning the Sensing System

The camera sensor on the windshield behind the rearview mirror, and the sensors on the front of the vehicle can become blocked by snow, ice, dirt, mud, or debris. This area needs to be cleaned for ACC to operate properly.

If ACC will not operate, regular cruise control may be available. See “Switching Between ACC and Regular Cruise Control” previously in this section. Always consider driving conditions before using either cruise control system.

For cleaning instructions, see “Washing the Vehicle” under *Exterior Care* ⇨ 349.

## Super Cruise

Super Cruise can steer to maintain lane position under certain conditions on Super Cruise-enabled roads that are separated from opposing traffic.

Super Cruise can also steer to perform a lane change under certain conditions on Super Cruise-enabled roads.

A lane change can be initiated by the driver using the turn signal lever.

The Super Cruise system may initiate a lane change maneuver in following scenarios:

- to pass slower traffic
- when the current lane is ending ahead
- to return to the initial lane
- to provide space for vehicles merging from an ending lane

See “Super Cruise Lane Change” later in this section and *Turn and Lane-Change Signals* ⇨ 125.

### Warning

Super Cruise can only assist to maintain lane position, or steer to change lanes, when driving on compatible roads. You must supervise the driving task and monitor the road conditions. You may need to respond to traffic events by steering, braking, or accelerating. See *Defensive Driving*.

Super Cruise is:

- Not a self-driving system
- Not a crash avoidance or warning system
- Not a substitute for proper supervision of the driving task.

Super Cruise uses the following to detect the current lane position and lane markings ahead on compatible roads under certain conditions:

- Cameras
- Global Positioning System (GPS) sensing
- A high-precision map
- GPS-enhancement data downloaded through OnStar

Super Cruise works with Adaptive Cruise Control (ACC), which controls acceleration and braking while Super Cruise is enabled and operating. Review and understand both this section and the ACC section before using Super Cruise. See *Adaptive Cruise Control (Advanced)* ⇨ 203.

An active Connected Service plan that includes Super Cruise Services is required to use Super Cruise.

### Warning

Super Cruise does not perform all aspects of driving, nor does it do everything a driver can do. Super Cruise only steers to maintain vehicle position in the current

(Continued)

**Warning (Continued)**

lane or, under some circumstances, to change lanes. Super Cruise can only be used with Adaptive Cruise Control.

Super Cruise does:

- Not prevent crashes or warn of possible crashes.
- Not steer to avoid stopped or slow-moving vehicles, cross-traffic, construction barriers or cones, motorcycles, children, pedestrians, animals, or other objects on the road.
- Not steer in response to vehicles or objects next to your vehicle, including vehicles attempting to enter your lane.
- Not respond to traffic lights, stop signs, or other traffic control devices.
- Not respond to crossing traffic.
- Not make turns.
- Not steer to merge onto or to exit highways.
- Not steer to avoid, or steer through construction zones.
- Not respond to oncoming traffic.
- Not function in city driving conditions.

**⚠ Warning**

Some state and local laws may require hands to be kept on the steering wheel at all times. Only remove your hands from the steering wheel if Super Cruise is engaged, it is safe to do so, and it is permitted by state and local laws.

**⚠ Warning**

Failure to supervise the driving task and to respond appropriately, even while Super Cruise is operating, can cause a crash. Super Cruise may not respond as you would to all driving situations and may not maintain lane position under all conditions.

It is extremely important to pay attention to the operation of the vehicle, even while using Super Cruise. Do not use a hand-held device while driving, even with Super Cruise engaged. To prevent serious injury or death:

- Always remain properly seated in the driver seat with your seat belt fastened.

(Continued)

**Warning (Continued)**

- Never remove your hands from the steering wheel when Super Cruise is not operating.
- Always make sure traffic conditions are safe before using Super Cruise.
- Always keep the entire vehicle and the sensors clean. Sensors are on the front, sides, and rear of the vehicle.
- Always observe posted speed limits. Only use Super Cruise at or below the posted speed limit.

Super Cruise should not be used in complex or uncertain driving conditions, including:

- Not in construction zones.
- Not when approaching or exiting toll plazas.
- Not when approaching an intersection that is controlled with a traffic light, stop sign, or other traffic control device.

(Continued)

**Warning (Continued)**



- Not when lane markings are not present or cannot be detected. For example, there is too much glare, weather conditions are poor, or lanes are poorly marked.
- Not on slippery or icy roads.
- Not in adverse weather conditions, including rain, sleet, fog, ice, or snow.
- Not on winding or hilly roads.
- Not for city driving.
- Not during heavy or emergency braking.
- Not on a road shoulder, service drive, or under an elevated freeway.
- Not when towing a trailer that does not meet GM approved guidelines.
- Not in a highway exit lane.

**When Super Cruise is Available****Super Cruise Indicator**

Super Cruise is designed to operate only when:

- ACC is on. See *Adaptive Cruise Control (Advanced)* ⇨ 203.
- Teen Driver is not active.
- The GPS detects the vehicle is on a compatible road.
- Both the camera and the radar sensors are functioning and not covered, obstructed, or damaged.
- The Driver Attention System (DAS) detects the driver's head and eyes are directed toward the road ahead.
- The lane markings are clearly visible and able to be detected by the system.
- If equipped with Adjustable Ride Height; Super Cruise allowable ride height is selected.

**Poor Conditions****Poor Conditions****Using Super Cruise****Warning**

To prevent serious injury or death, only remove your hands from the steering wheel if the steering wheel light bar, , and  are green. Super Cruise may



(Continued)

**Warning (Continued)**

not begin steering immediately, even when Super Cruise is available and  has been pressed.



To engage:

- Press  to turn on ACC. Make sure the white  indicator displays in the instrument cluster. See *Adaptive Cruise Control (Advanced)* ⇨ 203. When Super Cruise is available, the white  will display in the instrument cluster.

- Press . ACC will set the speed to the current vehicle speed or resume to the higher previously stored ACC set speed.

When engaged and not steering the vehicle, the steering wheel light bar flashes blue, and  will be blue. The driver is in control of steering and Super Cruise is not steering the vehicle.

When the vehicle is positioned in the center of the lane, the steering wheel light bar and  display will turn green, indicating Super Cruise is steering the vehicle.

When Super Cruise controls the steering, traffic and other conditions and laws permit, and it is safe to do so, your hands can be taken off the steering wheel.

Always pay attention to the road and the operation of the vehicle. Always monitor and be attentive of surrounding traffic, including vehicles that may cross the road in front of your vehicle.

Super Cruise steering can be overridden with manual steering at any time. When Super Cruise is engaged, always be prepared to take immediate action — including steering, accelerating, and braking quickly, if necessary.

Super Cruise, when engaged, will enable Forward Collision System to Alert and Brake.

**Steering Manually and Changing Lanes**

The vehicle can always be manually steered, even with Super Cruise engaged; for example, when manually changing lanes.

When the steering wheel is moved manually, the steering wheel light bar flashes blue and  on the instrument cluster turns blue to indicate Super Cruise is not steering the vehicle.

When ready to allow Super Cruise to resume steering again, position the vehicle in the center of the lane, hold the steering wheel until the steering wheel light bar turns green, and then release the steering wheel when it is safe to do so.

** Warning**

To help prevent crashes before making a lane change:

- Always check mirrors.
- Glance over your shoulder.
- Use the turn signals.

## Super Cruise Lane Change

### On Demand Lane Changes

Super Cruise can steer to perform a single lane change under certain conditions when requested by the driver or initiated by the Super Cruise System.

To request a lane change:

1. Verify the lane next to your vehicle is clear and conditions are safe to make a lane change.
2. Use the turn signal lever to activate the turn signal in the direction of the desired lane change.
3. Return the turn signal lever to the neutral position after the lane change. See *Turn and Lane-Change Signals* ⇨ 125.
4. To cancel a lane change, return the turn signal lever to the neutral position, move the lever in the opposite direction of the lane change, or steer manually at any time.

### Automatic Lane Changes

Super Cruise System may initiate a single lane change when enabled through Vehicle Personalization under following conditions:

- The Super Cruise System may initiate an automatic lane change to the left to pass a slower moving vehicle ahead and a subsequent lane change to right to return to your original lane.
- The Super Cruise System may initiate an automatic lane change to left or right when current lane is ending ahead.
- The Super Cruise System may initiate an automatic lane change to left or right when a slower moving vehicle is detected in the adjacent ending lane to provide space for merging vehicle.
- To cancel a Super Cruise lane change, move the turn signal lever or steer manually at any time.

If Super Cruise detects that traffic is clear, Super Cruise will steer the vehicle to perform the lane change. A message appears on the Driver Information Center (DIC) during the lane change to provide more information on the status of the lane change.

Super Cruise Lane Change functionality is only available on Super Cruise capable Divided Roads.

Super Cruise Lane Change may be disabled when a trailer or other accessories (e.g. bike rack, cargo tray, etc.) are detected.

Do not use Super Cruise Lane Change when towing a trailer.

The Super Cruise Lane Change feature can be customized to be Off, On Demand Lane Change, or On Demand Lane Change & Automatic Lane Change through the vehicle personalization menu. Touch the Settings icon on the infotainment home page. Select "Vehicle" to display the list of available options and select "Super Cruise Lane Change."

**Warning**

Super Cruise Lane Change may not detect a vehicle in an adjacent lane. Always supervise the driving task and monitor traffic conditions when using the Super Cruise Lane Change feature. Only request a lane change when traffic conditions are safe for a lane change, and always be ready to manually steer the vehicle. See “Steering Manually and Changing Lanes” listed previously in this section.

**Take Over Alert****Warning**

Super Cruise will not maintain the vehicle’s speed while the steering wheel light bar is flashing red. If the steering wheel light bar flashes red, immediately resume manual steering to prevent serious injury or death. If you do not resume manual steering, the vehicle will begin to slow in the same lane and eventually come to a complete stop on the road.

Any time the steering wheel light bar flashes red, resume manual steering immediately.

To begin steering manually, hold the steering wheel firmly (with both hands) using the highlighted regions as shown in the picture below.



The instrument cluster light , will also turn red and a message will display in the Driver Information Center (DIC). In addition, beeps will sound, or the Safety Alert Seat will vibrate. To view available settings from the infotainment screen, touch Settings > Vehicle > Collision/Detection Systems. After you begin steering manually, then Super Cruise will disengage.

The red flashing steering wheel light bar could occur under any of the following conditions:

- Lane markings are poor or visibility is limited.
- The Driver Attention System (DAS) does not detect that the driver’s head and eyes are directed toward the road.
- ACC is canceled.
- The vehicle is on a tight curve, or the lanes are too wide, or the vehicle goes into a curve too fast.
- The road speed limit of Super Cruise capable non-divided road is below 72 km/h (45 mph).
- The compatible road ends.
- The vehicle is approaching an intersection controlled by a traffic light, stop sign, or other traffic control device.
- A Super Cruise system fault occurs.
- Super Cruise is unable to complete the lane change maneuver.

**Attention to the Road** **Warning**

Super Cruise is a driver assistance system and cannot accurately detect or predict all situations. Super Cruise is not a crash avoidance system. To prevent serious injury or death, you must supervise the driving task and monitor the road conditions. You may need to respond to traffic events by steering, braking, or accelerating. See *Defensive Driving* ⇨ 164. Super Cruise also cannot determine whether you are awake, asleep, impaired, or properly focused on safe driving. The vehicle could crash into other vehicles, drive out of the lane, or drive off the road. Complete attention is always required while driving, even while using Super Cruise. Be prepared to take over steering or apply the brakes at any time.

 **Warning**

To prevent serious injury or death, be alert and pay special attention when passing highway exits, entrances, and crossings with Super Cruise, and be ready to take control of the vehicle when necessary. Changes in lane markings around exits and entrances can momentarily cause Super Cruise to not detect the correct lane. If this occurs, Super Cruise may attempt steering inputs to bring the vehicle back into the correct lane and, in rare circumstances, could over-correct and cause the vehicle to momentarily cross into a lane next to your vehicle unless you manually steer to maintain your lane position.

The Driver Attention System (DAS) on the steering column continually monitors driver head and eye position to estimate driver attention to the road. The camera does not record or share pictures, audio, or video.

Sunglasses, hats, or other types of clothing that change the shape of the head may interfere with camera performance. To improve camera performance, raise or lower the steering wheel, or change the seat position.

Pay close attention to the road ahead to avoid these three increasing alerts:



First Alert	<ul style="list-style-type: none"><li>• If the steering wheel light bar flashes green, the system has detected that your head and eyes may not be directed toward the road.</li><li>• The flashing will stop when the system detects that your head and eyes appear to be directed toward the road.</li></ul>
Second Alert	<ul style="list-style-type: none"><li>• If the steering wheel light bar flashes green for too long, Super Cruise will alert the driver to take control of steering immediately by flashing the light bar red. Also, either beeps will sound or the Safety Alert Seat will vibrate. To view available settings from the infotainment screen, touch Settings &gt; Vehicle &gt; Collision/Detection Systems.</li><li>• Take over steering, then Super Cruise will disengage.</li><li>• To re-engage Super Cruise, press . See “Using Super Cruise” previously in this section.</li></ul>
Third Alert	<ul style="list-style-type: none"><li>• If the steering wheel light bar flashes red for too long, a voice command will tell you to take control of the vehicle.</li><li>• Take control of the steering immediately; ACC and Super Cruise will disengage.</li><li>• A DIC message will indicate that Super Cruise is locked out. Super Cruise cannot be re-engaged until the vehicle is turned off and turned back on again.</li><li>• Continued failure to take over steering will cause the vehicle to brake to a stop and OnStar will be called. The brake lamps and hazard warning flashers will come on.</li><li>• Take control of the vehicle and continue driving.</li></ul>

### Stationary or Very Slow-Moving Objects; Cross-Traffic

#### Warning

Super Cruise is not a crash avoidance system and will not steer or brake to avoid a crash. Super Cruise does not steer to prevent a crash with stopped or slow-moving vehicles. You must supervise the driving task and may need to steer and brake to prevent a crash, especially in stop-and-go traffic or when a vehicle suddenly enters your lane. Always pay attention when using Super Cruise. Failure to do so could result in a crash involving serious injury or death.

### Curves in the Road

#### Warning

The vehicle could drift out of your lane of travel. To prevent crashes, always be ready to manually steer. Super Cruise may not detect your lane on curves in the road. Super Cruise may not detect the markings that show your lane. You may not have time to react to a vehicle

(Continued)

#### Warning (Continued)

in the lane next to your vehicle while on curves in the road. Super Cruise may hand control back to the driver more often driving around a sharp curve while towing a trailer.

Super Cruise may operate differently in sharp curves. It may drift out of your lane of travel if the curve is too sharp.

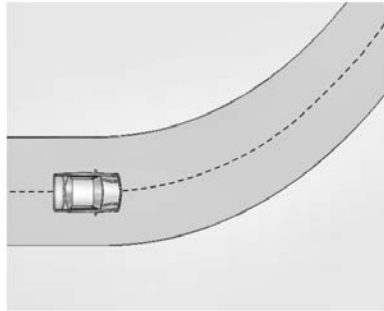

When entering a curve, Super Cruise may not detect the lane markings and may not adjust the steering enough to stay in your lane of travel. When this happens, you will need to steer the vehicle.

Super Cruise may detect other lane markings that are not in your lane and may or may not steer appropriately to maintain your lane.

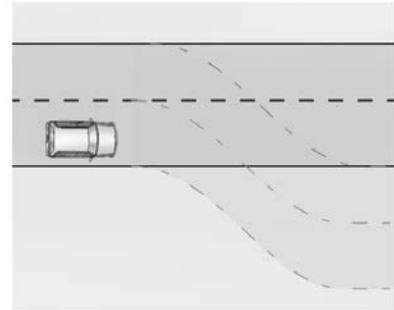

Super Cruise may occasionally provide an alert and/or steering that is considered unnecessary. It could respond to lane markings in different lanes, signs, guardrails, and other stationary objects when entering or exiting a curve. This is normal operation. The vehicle does not need service.

### Other Vehicles Entering Your Lane

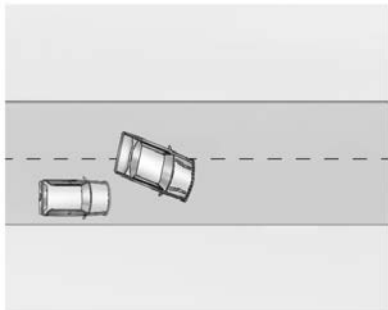

Super Cruise may not detect a vehicle that enters your lane, or may not brake fast enough to avoid a crash. You must manually brake and steer the vehicle.

### Intersections; Vehicles Crossing the Road Ahead

Super Cruise will not brake the vehicle when approaching an intersection that is controlled by a traffic light or stop sign. Super Cruise will not detect vehicles crossing the road ahead, including at intersections, and will not automatically steer or brake to prevent a collision. You must manually brake and steer the vehicle.

### Towing a Trailer

Super Cruise may be used when towing a trailer when Trailer attached is within size and weight limits designated in the Trailer Towing section, see *Trailer Towing* ⇨ 266.

When Super Cruise is used with vehicles equipped with aftermarket trailer brake controller, Super Cruise may not disengage when manual trailer brake is applied.

Do not use Super Cruise Lane Change when towing a trailer.

For additional information on towing a trailer, see *Trailer Towing* ⇨ 266.

### Super Cruise on Hills

Do not use Super Cruise while driving on steep hills.

### Super Cruise on Non-Divided Roads

Super Cruise may be available on non-divided roads that are mapped, outside of urbanized areas and have a road speed limit above 72 km/h (45 mph).

### Super Cruise Indicator Light Summary



The steering wheel light bar and instrument cluster light provide the following important information about Super Cruise operation:

Steering Wheel Light Bar	Instrument Cluster Light	Super Cruise Description
Off	Off	Super Cruise is off. There is no automatic steering. Operate the vehicle manually.
Off	White	Super Cruise is available and can be engaged.
Solid Green	Solid Green	Super Cruise is steering. Pay attention to the road and vehicle operation.
Flashing Blue	Solid Blue	Super Cruise is not steering. Operate the vehicle manually. See “Steering Manually and Changing Lanes” previously in this section.
Flashing Green	Solid Green	Super Cruise has detected you are not paying sufficiently close attention to the road. Pay attention to the road. See “Attention to the Road” previously in this section.
Flashing Red	Solid Red	Take over steering immediately. Super Cruise will disengage. See “Take Over Alert” previously in this section.



**Disengaging Super Cruise**

There are two ways to disengage Super Cruise:

- Press  while your hands are on the steering wheel. The Super Cruise steering will disengage.

- Press the brake pedal or press the regen on demand paddle while your hands are on the steering wheel. Both Super Cruise steering and Adaptive Cruise Control will disengage.

**Super Cruise Messages**

If  does not appear,  can be pressed to display a DIC message as to why the system is unavailable.

Immediately after a disengagement, pressing the  within 10 seconds will display a DIC message with the reason for Super Cruise disengagement.

**Super Cruise Message Summary**

Subscription Required Press OnStar Button	<ul style="list-style-type: none"><li>• The owner's required Connected Services subscription may have ended.</li><li>• Press the Blue OnStar button in your vehicle to speak with an OnStar representative, who can help determine the issue and what actions to take</li></ul>
Unavailable Turn on Adaptive Cruise Control	<p>Adaptive Cruise Control must be on before Super Cruise can be enabled.</p> <ul style="list-style-type: none"><li>• Set speed is not required before enabling Super Cruise.</li><li>• Adaptive Cruise Control is not required to be engaged before enabling Super Cruise.</li></ul>
Unavailable Lane Ending	<p>Super Cruise is disabled because the driving lane is ending.</p>
Unavailable No Road Information	<ul style="list-style-type: none"><li>• There is no map information available for that portion of the road. Recent road reconstruction may turn off Super Cruise for that section of road until new map information is available.</li><li>• The vehicle is not on the correct type of road. A controlled access freeway or compatible divided or non-divided road is required for Super Cruise.</li><li>• There are lanes entering or exiting on both the left and right side of the road.</li></ul>
Unavailable Sensors Can't Find Lane Lines	<ul style="list-style-type: none"><li>• Rain or snow is inhibiting the system's ability to see lane lines.</li><li>• Direct sunlight is on the front camera at dawn or dusk.</li><li>• There are missing or poor lane line markings on the road.</li><li>• There is sun glare on the road surface.</li><li>• There is heavy rain, puddles, or road spray.</li></ul>

## Super Cruise Message Summary (cont'd)

Unavailable Sensor Can't See Face Clearly	<ul style="list-style-type: none"> <li>• Cups, food, hands, or other objects are obscuring the DAS view of the driver's face.</li> <li>• The steering column is pointed too high or low for the DAS to see the driver. Adjust the steering column or the seat if the message occurs frequently.</li> <li>• Sun is shining into the Driver Attention System (DAS) camera.</li> <li>• Dawn or dusk sun glare is on the driver's face.</li> </ul>
Unavailable Looking Away From Road for Too Long	The DAS system detects that the driver is not looking at the road.
Unavailable Driving Too Fast	<p>The vehicle is traveling faster than 137 km/h (85 mph).  The vehicle is traveling more than 16 km/h (10 mph) over road speed limit on super cruise capable non-divided road.  The maximum Super Cruise speed in curves will vary based on how sharp the curve is. The vehicle will automatically decrease speed if needed.</p>
Unavailable Driving in Exit Lane	The Super Cruise system has detected that the vehicle is in an exit lane.
Unavailable GPS Signal Lost	<ul style="list-style-type: none"> <li>• There is poor reception in isolated areas.</li> <li>• Reception is being blocked by buildings or other large structures.</li> </ul>
Unavailable You Have Taken Vehicle Control	<ul style="list-style-type: none"> <li>• The brake pedal is being pressed.</li> <li>• The Adaptive Cruise Control has been canceled or turned off.</li> </ul>
Unavailable Sensor Blocked	Clear snow, ice, dirt, or other contaminants from the front and rear areas of the vehicle.
Unavailable Sharp Curve	Some curves are too sharp to be navigated by the Super Cruise system. Super Cruise will be available after the curve is traveled.

**Super Cruise Message Summary (cont'd)**

Unavailable Over Weight Limit	Super Cruise has detected trailer is over allowable weight limit.
Unavailable Trailer Too Unstable	Super Cruise has detected that trailer attached is causing unstable condition. Check trailer and/or load.
Unavailable Trailer Too Large	Trailer size (length/width) is larger than supported for Super Cruise operation.
Unavailable Lane Too Narrow	Super Cruise has detected lane width ahead is too narrow for Super Cruise operation while towing a trailer.
Super Cruise Unavailable	Super Cruise is unavailable for reasons not described in other messages.
Super Cruise Locked Out See Owner's Manual	The driver did not take control of the vehicle when prompted by the Super Cruise system. The Super Cruise system will be disabled until the vehicle is turned off and back on.
Construction Zone Drive With Care	Super Cruise has detected a construction zone.

**Map Updates**

Super Cruise map information must be periodically updated at least once every seven months to determine whether Super Cruise is available on certain roads.

See the following website for Super Cruise map open source compliance documentation, including the license information:

<https://oss.veoneer.com/>

**Data Download**

If the vehicle is equipped with OnStar and has an active service plan, additional data may be collected through the OnStar system. This includes information about: the vehicle's operation; a crash involving the vehicle; the use of the vehicle and its features; and, in certain situations, the location and approximate GPS speed of the

vehicle. Refer to the OnStar Terms and Conditions and Privacy Statement on the OnStar website.

**Location Services**

This setting enables or disables sharing of vehicle location outside the vehicle for certain purposes. Even if the Location

Services setting is disabled, vehicle location information will continue to be shared for emergency services and Super Cruise.

**System Care**

The camera on the steering column has a lens cover that may become dirty over time and affect camera performance. Clean the lens cover with a soft cloth sprayed with glass cleaner. Wipe the lens gently, then dry it. Never use abrasive cloths/cleaners or corrosive chemicals of any kind on the lens cover.

Super Cruise uses the front radar, front camera, and 360 degree cameras for its operation. Clean surfaces are required for Super Cruise operation. See *Adaptive Cruise Control (Advanced)* ⇨ 203, “Surround Vision Camera” under *Assistance Systems for Parking or Backing* ⇨ 228, and *Lane Keep Assist (LKA)* ⇨ 250 for care information.

<b>Caution</b>
<p>The Super Cruise system is a highly sophisticated system and should only be serviced by technicians with the proper training, tools, and safety instructions, (Continued)</p>

<b>Caution (Continued)</b>
<p>which your dealer has. Without proper training and tools the vehicle may become damaged.</p>

**Driver Assistance Systems**

This vehicle may have features that work together to help avoid crashes or reduce crash damage while driving, backing, and parking. Read this entire section before using these systems.

 <b>Warning</b>
<p>Do not rely on the Driver Assistance Systems. These systems do not replace the need for paying attention and driving safely. You may not hear or feel alerts or warnings provided by these systems. Failure to use proper care when driving may result in injury, death, or vehicle damage. See <i>Defensive Driving</i> ⇨ 164.</p> <p>Under many conditions, these systems will not:</p> <ul style="list-style-type: none"> <li>• Detect children, pedestrians, bicyclists, or animals.</li> </ul> <p style="text-align: right;">(Continued)</p>

<b>Warning (Continued)</b>
<ul style="list-style-type: none"> <li>• Detect vehicles or objects outside the area monitored by the system.</li> <li>• Work at all driving speeds.</li> <li>• Warn you or provide you with enough time to avoid a crash.</li> <li>• Work under poor visibility or bad weather conditions.</li> <li>• Work if the detection sensor is not cleaned or is covered by ice, snow, mud, or dirt.</li> <li>• Work if the detection sensor is covered up, such as with a sticker, magnet, or metal plate.</li> <li>• Work if the area surrounding the detection sensor is damaged or not properly repaired.</li> </ul> <p>Complete attention is always required while driving, and you should be ready to take action and apply the brakes and/or steer the vehicle to avoid crashes.</p>



### Audible or Safety Alert Seat

Some driver assistance features alert the driver of obstacles by beeping. To view available settings from the infotainment screen, touch Settings > Vehicle > Comfort and Convenience.

With the Safety Alert Seat, the driver seat cushion may provide a vibrating pulse alert instead of beeping. To view available settings from the infotainment screen, touch Settings > Vehicle > Collision/Detection Systems.

### Cleaning

Depending on vehicle options, keep these areas of the vehicle clean to ensure the best driver assistance feature performance. Driver Information Center (DIC) messages may display when the systems are unavailable or blocked.



- Front and rear bumpers and the area below the bumpers
- Front grille and headlamps
- Front camera lens in the front grille or near the front emblem

- Front side and rear side panels
- Outside of the windshield in front of the rearview mirror
- Side camera lens on the bottom of the outside mirrors
- Rear side corner bumpers
- Rear Vision Camera in the tailgate handle
- Rear Camera Mirror and Cargo View Camera in the Center High-Mounted Stoplamp

### Radio Frequency

This vehicle may be equipped with driver assistance systems that operate using radio frequency. See *Radio Frequency Statement* ⇨ 374.

### Assistance Systems for Parking or Backing

The Rear Vision Camera (RVC), Surround Vision, Rear Park Assist (RPA), Front and Rear Park Assist (FRPA), and Rear Cross Traffic Alert (RCTA) may help the driver park or avoid objects. Always check around the vehicle when parking or backing.

## Rear Vision Camera (RVC)

When the vehicle is shifted into R (Reverse), the Rear Vision Camera (RVC) displays an image of the area behind the vehicle in the infotainment display. The previous screen displays when the vehicle is shifted out of R (Reverse) after a short delay. To return to the previous screen sooner, press Home or Back on the infotainment system, shift into P (Park), or reach a vehicle speed of approximately 12 km/h (8 mph) while in D (Drive).

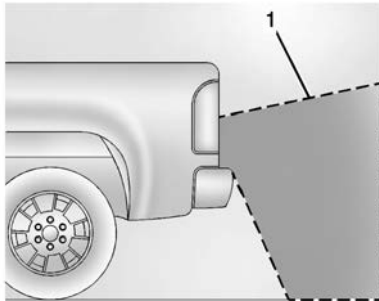

1. View Displayed by the Camera

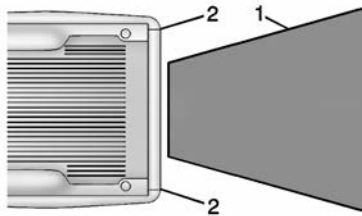

1. View Displayed by the Camera
2. Corners of the Rear Bumper

Displayed images may be farther or closer than they appear. The area displayed is limited and objects that are close to either corner of the bumper or under the bumper do not display.

A warning triangle may appear on the infotainment display to show that Rear Park Assist (RPA) or Rear Cross Traffic Alert (RCTA) has detected an object. This triangle changes from amber to red and increases in size the closer the object.

### Warning

The camera(s) do not display children, pedestrians, bicyclists, crossing traffic, animals, or any other object outside of  
(Continued)

### Warning (Continued)

the cameras' field of view, below the bumper, or under the vehicle. Shown distances may be different from actual distances. Do not drive or park the vehicle using only these camera(s). Always check behind and around the vehicle before driving. Failure to use proper care may result in injury, death, or vehicle damage.

## Surround Vision System

The Surround Vision system can display various views surrounding the vehicle on the infotainment display. See below for camera view descriptions and more information.

### Warning

The Surround Vision cameras have blind spots and will not display all objects near the corners of the vehicle. Folding outside mirrors that are out of position may not display surround view correctly. Always check around the vehicle when parking or backing.

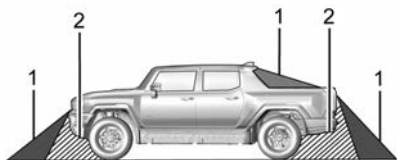

1. Views Displayed by the Surround Vision Cameras
2. Area Not Shown

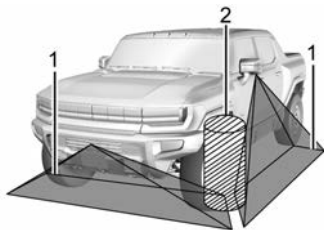

1. Views Displayed by the Surround Vision Cameras
2. Area Not Shown

**Warning**

The camera(s) do not display children, pedestrians, bicyclists, crossing traffic, animals, or any other object outside of the cameras' field of view, below the bumper, or under the vehicle. Shown distances may be different from actual distances. Do not drive or park the vehicle using only these camera(s). Always check behind and around the vehicle before driving. Failure to use proper care may result in injury, death, or vehicle damage.

**Camera Views**

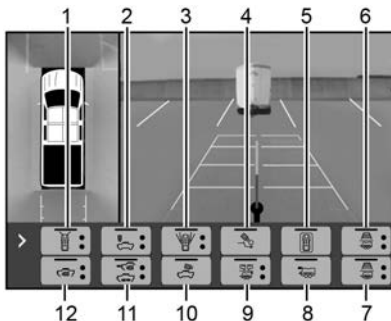

Touch the camera view icons along the bottom of the infotainment display to access each view:

1. Front/Rear Standard View  
Displays an image of the area in front or behind the vehicle. To select, touch Front/Rear Standard View on the infotainment display when a camera view is active.  
When the hitch guidance is selected, Rear Standard View will remain visible across gear changes, otherwise the view will toggle between Front and Rear Standard View based on gear position.

The front view camera also displays when the Park Assist system detects an object within 30 cm (12 in).  
To access this view when in a forward gear above 12 km/h (8 mph), select CAMERA on the infotainment display and select Rear Standard View. The view will close after 8 seconds and can be closed early by selecting X, Home or Back.

## 2. Front/Rear Top-Down View

Displays a front or rear overhead view of the vehicle. To view, select Front/Rear Top-Down View on the infotainment display when the camera app is active.

## 3. Front/Rear Side View

Displays a view that shows objects next to the front or rear sides of the vehicle. To select, touch Front/Rear Side View on the infotainment display when a camera view is active. Touch the button to toggle between front and rear camera views. Park Assist and RCTA overlays are not available when Front/Rear Side View is active.

## 4. Hitch View

Displays a zoomed-in view of the hitch area to assist with aligning the vehicle's hitch ball with the trailer coupler and monitoring the trailer connection. To view, select Hitch View on the infotainment display when the camera app is active. To access this view when in a forward gear above 12 km/h (8 mph), select CAMERA on the infotainment display and select Hitch View. The view will close after eight seconds and can be closed early

by selecting X, Home or Back. Shifting into P (Park) while in this view may automatically engage the Electric Parking Brake (EPB).

## 5. Surround View

Displays an image of the area surrounding the vehicle. Surround View is displayed alongside the currently selected view when below 12 km/h (8 mph). Surround View is disabled when above 12 km/h (8 mph).

## 6. Camera App Guidance Lines

The camera app supports three possible guidance modes: No Guidance, Vehicle Guidance and Trailing Guidance. To change guidance mode, select the appropriate guidance icon. Depending on the guidance mode and view selected, different guidance lines may appear. A grayed-out icon indicates that guidance lines are not available. Certain views do not support guidance lines.

- Standard Guidance Lines are available in Front/Rear Standard Views, Front/Rear Top-Down Views and Surround View when the

Vehicle Guidance mode is selected. Standard Guidance Lines show current and intended vehicle path.

- Hitch Guidance Line is available in Rear Standard View or Cargo Bed View when the Trailing Guidance mode is selected. Hitch Guidance displays a single centered guidance line on the infotainment display to assist with aligning the vehicle's hitch with a trailer coupler. Align the Hitch Guidance Line with the trailer coupler by continuously steering the vehicle to keep the guidance line centered on the coupler when backing. Park Assist overlays will not display when the Hitch Guidance Line is active.
- Rear Trailer Guidance Lines are available in the Rear Trailer View when the Trailing Guidance mode is selected and the rear trailer camera calibration has been successfully completed. Rear Trailer Guidance Lines show the intended path (yellow) and the current path (blue) of the trailer. The current path guidance lines will converge with the intended path guidance lines.

## 7. Camera App Guidance Lines

Duplicate of item 6.

## 8. Transparent Trailer View

Displays a view that allows the driver to virtually “see through” the trailer. The feature is available when a compatible trailer is connected, a valid profile is selected and the vehicle is not in R (Reverse). The feature requires user installation of an accessory trailer camera on the rear exterior surface of the trailer per the accessory trailer camera installation instructions (see your dealer for accessory trailer camera(s) and information). To view, select Transparent Trailer View on the infotainment display when the camera app is active. To access this view when in a forward gear above 12 km/h (8 mph), select CAMERA on the infotainment display and select Transparent Trailer View. The view can be closed by selecting X, Home or Back.

When the system is calibrated and trailer position is known, one of three views will be shown; Transparent Trailer View, Left Transparent Trailer

View or Right Transparent Trailer View. The Transparent Trailer View is shown when the position of the trailer is relatively straight behind the vehicle. The Left or Right Transparent Trailer view is shown when the position of the trailer is too far to the left or right. When the system is not calibrated or trailer position is not known the Transparent Trailer Picture-in-Picture View will be shown.

## 9. Rear Trailer Views

## • Rear Trailer View

Displays a view of the area behind the trailer when a trailer is connected. The feature requires user installation of an accessory trailer camera on the rear exterior surface of the trailer per the accessory trailer camera installation instructions (see your dealer for accessory trailer camera(s) and information). To view, select Rear Trailer View on the infotainment display when the camera app is active. To access this view when in a forward gear above 12 km/h (8 mph), select CAMERA on the infotainment

display and select Rear Trailer View. The view can be closed by selecting X, Home or Back.

## • Rear Side View with Available Articulation Functionality

Displays a rearward split view of the left and right sides of the vehicle and trailer, when a trailer is connected. The view will automatically pan to show more of the left or right side based on the position of the trailer when a compatible profile is configured and selected via the Trailing App. To view, select Rear Side View with Available Articulation Functionality on the infotainment display when the camera app is active. To access this view when in a forward gear above 12 km/h (8 mph), select CAMERA on the infotainment display and select Rear Side View with Available Articulation Functionality. The view can be closed by selecting X, Home or Back.

- **Picture-in-Picture Side View**

Displays a rearward split view of the left and right sides of the vehicle and trailer with an overlay view of the area behind the trailer when a trailer is connected. The feature requires user installation of an accessory trailer camera on the rear exterior surface of the trailer per the accessory trailer camera installation instructions (see your dealer for accessory trailer camera(s) and information). To view, select Picture-in-Picture Side View on the infotainment display when the camera app is active. To access this view when in a forward gear above 12 km/h (8 mph), select CAMERA on the infotainment display and select Picture-in-Picture Side View. The view can be closed by selecting X, Home or Back.

#### 10. Cargo Bed View

Use the plus and minus icons on the infotainment display to zoom in or out.

Displays a view of the truck bed and the area behind the vehicle to assist in cargo or hitch monitoring or

hitching to a fifth wheel or gooseneck trailer. To view, select Cargo Bed View on the infotainment display when the camera app is active. To access this view when in a forward gear above 12 km/h (8 mph), select CAMERA on the infotainment display and select Cargo Bed View. The view will close after 8 seconds and can be closed early by selecting X, Home or Back. When the Cargo Bed View is selected when not in D (Drive) the cargo bed lighting is turned on automatically. The feature can be enabled or disabled. To view available settings from the infotainment screen, touch Settings > Vehicle > Collision/ Detection Systems.

#### 11. Underbody Split: Front-Forward/ Forward-Rearward

Displays a split screen of two camera images. Touch the Underbody Split view on the infotainment display when a camera is active. Touching the button multiple times will toggle between a split of the front grille camera with Underbody Forward and Underbody Forward with Underbody

Rearward. Park Assist and RCTA overlays are not available when Underbody Split is selected.

#### 12. Underbody Forward/Rearward

Displays an image of the area under the vehicle in the front or rear. The forward-facing camera is positioned to see the area below the front of the vehicle and may include the rear of the front tires and suspension components. Touch the Underbody Front/Rear view on the infotainment display when a camera is active. Touching the button multiple times will toggle between front and rear camera views.

#### Additional Views and Alerts

- **Turn Signal Activated Views**

Displays a rearward view of the left or right side of the vehicle and trailer when a trailer is connected. Views are provided based on turn signal activation with the right-side view being shown when the right turn signal is active and the left side view being shown when the left turn signal is active. The feature can be enabled or disabled. To view available settings from the infotainment screen,

touch Settings > Vehicle > Collision/Detection Systems. The view can be closed early by selecting X, Home or Back.

A Trailer Length Indicator Overlay is available in the Turn Signal Activated Views when the trailer is relatively straight behind the vehicle and a compatible profile is configured and selected via the Trailing App. The overlay will not be visible when the position of the trailer is too far to the left or right. The overlay can be enabled or disabled. To view available settings from the infotainment screen, touch Settings > Vehicle > Collision/Detection Systems.

- **Jack-Knife Detection and Alert**

The vehicle may be equipped with Jack-Knife Detection. The system will track the position of the trailer relative to the vehicle. As the front of the trailer approaches the rear of the vehicle, a warning or an alert will be displayed. A warning indicates to the driver to proceed with caution and an alert indicates that a collision is imminent. Based on vehicle equipment and user settings, the visual warning or alert may be accompanied by audible or safety alert seat notifications. To view available

settings from the infotainment screen, touch Settings > Vehicle > Collision/Detection Systems.

- **Trailer Angle Indicator**

The vehicle may be equipped with a Trailer Angle Indicator. The Trailer Angle Indicator gives the driver a visual representation of the trailer's position relative to the vehicle. (Available only in R (Reverse), Guidelines On, or Rear Trailing Views).

- **When driving Off-Road the system will allow camera usage at higher speeds to improve safety and awareness. To activate place the vehicle drive mode in Off-Road or CrabWalk. In this mode all Camera Views in the infotainment display will be available at higher speeds.**

- **An underbody camera wash function can be activated by touching the camera wash icon on the infotainment display while any Underbody Camera view is active. Touching the button will activate the camera wash. Pressing and holding the button will activate the wash for an extended period of time. Underbody camera wash will not work if the front**

windshield washers are activated at the same time. See "Underbody Camera" at the end of this section.

### **Warning**

Use Hitch Guidance only to help back the vehicle to a trailer hitch or, when traveling above 12 km/h (8 mph), to briefly check the status of your trailer. Do not use for any other purpose, such as making lane change decisions. Before making a lane change, always check the mirrors and glance over your shoulder. Improper use could result in serious injury to you or others.

### **HD Surround Vision with Trailer Camera Provisions**

The system shows multiple views in the infotainment display using five cameras mounted around the vehicle and up to two additional accessory cameras that can be mounted on or in a trailer. This feature provides additional views to aid in trailering/towing. The front camera is in the grille under the front emblem, the side cameras are on the bottom of the outside

mirrors, the rear camera is in the tailgate handle and the bed camera is mounted on the rear of the cab.

Additionally, up to two accessory cameras can be mounted to the rear and/or interior of the trailer. See your dealer for accessory trailer cameras. To access, touch CAMERA on the infotainment display or shift to R (Reverse). To return to the previous screen when not in R (Reverse), touch the Home or Back buttons on the infotainment display.

Certain trailer views require a compatible trailer profile be configured and selected. A compatible trailer is a box type trailer (cargo, camper, etc.) with a conventional hitch.

Available camera views:

- Front/Rear Standard View
- Front/Rear Top-Down View
- Rear Bowl View
- Front/Rear Side View
- Hitch View
- Bed View
- Rear trailer View
- Rear Side view with a available articulation functionality
- Picture-in-Picture Side View

- Transparent Trailer View
- Surround View
- Guidance Lines
- Hitch Guidance

#### Troubleshooting

The Trailer Camera calibration may take longer than expected or not calibrate if:

- The vehicle is driven too fast during calibration. Speed should be maintained below 50 km/h (31 mph).
- The vehicle is not driven straight during calibration. Steering should be maintained as straight as possible. Excessive Steering during calibration may extend calibration time.
- The calibration is attempted in low light. Calibration should be attempted when there is enough light.
- The calibration is attempted during adverse weather conditions. Calibration during conditions such as snow or heavy rain should be avoided.
- The road surface is not ideal for calibration. Calibration should be attempted on an alternate road surface.

- The accessory trailer cameras are swapped at the hitch connector. Ensure that the camera mounted to the rear of the trailer is connected to the rear trailer camera input.
- The accessory trailer camera is mounted, angled or rotated outside of the defined mounting location (see camera installation instructions).
- The vehicle or accessory trailer camera is obstructed by dirt or debris. Check cameras and clean as needed.
- The accessory trailer camera is mounted such that obstructions are visible in the view (spare tire, bike/cargo racks, etc.). Calibration should be attempted with obstruction temporarily removed. Shadows resulting from driving toward the sun may be perceived as obstructions. Attempt to calibrate driving in an alternate direction if possible.
- The entered trailer profile dimensions are inaccurate. Measurements are expected to be made to the nearest centimeter or inch. Enter accurate measurements and reattempt calibration.



Distortion may be observed in a rear trailer camera view if:

- The accessory trailer camera is mounted, angled or rotated outside of the defined mounting location (see camera installation instructions).
- The entered trailer profile dimensions are inaccurate. Measurements are expected to be made to the nearest centimeter or inch. Enter accurate measurements and reattempt calibration.

The preview may not be provided or the wrong preview may be provided if:

- The accessory cameras are not recognized. Ensure that the accessory camera(s) are connected and restart the vehicle.
- The accessory trailer cameras are swapped at the hitch connector. Ensure that the accessory camera(s) are connected to the correct input.
- The accessory trailer camera(s) are not installed according to the installation instructions.

A feature may be unavailable or not activating as expected if:

- The trailer is not compatible.
- The customization is disabled. Check the customization settings where applicable.

- The accessory trailer cameras are swapped at the hitch connector. Ensure that the accessory camera(s) are connected to the correct camera input.
- A trailer profile is not configured and selected.
- The entered trailer profile dimensions are inaccurate. Measurements are expected to be made to the nearest centimeter or inch. Enter accurate measurements and reattempt calibration.
- The trailer position is not known. Drive straight forward to learn trailer position.
- The rear vehicle camera is obstructed by dirt or debris. Check cameras and clean as needed.
- Transparent Trailer, Standard Guidelines, Rear Trailer Guidelines, Articulation Angle Indicator, Jack Knife Detection are unavailable with CrabWalk activated.

Certain viewing features may experience degraded performance if:

- The entered trailer profile dimensions are inaccurate. Measurements are expected to be made to the nearest centimeter or inch. Enter accurate measurements and reattempt calibration.

- The rear vehicle camera is obstructed by dirt or debris. Check cameras and clean as needed.

For trailers with outboard wheels:

- Performance for Transparent Trailer and Jack Knife Detection are optimized when the entered value for trailer width reflects the width of the box of the trailer. If total width is entered:
  - The inlayed camera view in Transparent Trailer View may appear wider than the trailer face.
- The rear vehicle camera is obstructed by dirt or debris. Check cameras and clean as needed.
- Jack Knife Detection alerts may activate prematurely.
- Performance for Transparent Trailer and Jack Knife Detection are optimized when the entered value for trailer width reflects the width of the box of the trailer. If total width is entered:
  - The inlayed camera view in Transparent Trailer View may appear wider than the trailer face.
  - Jack Knife Detection alerts may activate prematurely.

- Performance for Rear Trailer Guidance Lines and Trailer Length Indicator Overlays are optimized when the entered value for trailer width reflects the total width of the trailer including outboard wheels. If the trailer box width is entered:
  - The Rear Trailer Guidance Lines will appear narrower than the actual path of the trailer.
  - The Trailer Length Indicator Overlays will appear closer and possibly overlap with the trailer.

### Underbody Camera

There are two cameras underneath the vehicle that show a view of the areas underneath the front and rear bumper. This feature is activated through the infotainment display.

The cameras can be washed by the following procedure:

1. Touch CAMERA on the infotainment display.
2. Select the front/rear underbody camera view.
3. Choose which camera to wash. Only one can be washed at a time and the screen cannot be split between both.

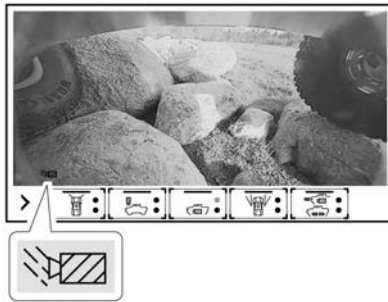

4. Touch the symbol on the lower-left of the infotainment display to activate the washer.

If there is excessive or dry debris on the shield in front of the camera lens, the activated washer may not effectively clean it. A manual cleaning may be necessary.

Excessive or prolonged use may cause damage to the shield. Periodic service or replacement may be required.

### Park Assist

With Front and Rear Park Assist, as the vehicle moves at speeds of less than 8 km/h (5 mph) the sensors on the bumpers may detect objects up to 1.2 m (4 ft) in front and

2.5 m (8 ft) behind the vehicle within a zone 25 cm (10 in) high off the ground and below bumper level. These detection distances may be shorter during warmer or humid weather. Blocked sensors will not detect objects and can also cause false detections. Keep the sensors clean of mud, dirt, snow, ice, and slush; and clean sensors after a car wash in freezing temperatures.

### Warning

The Park Assist system does not detect children, pedestrians, bicyclists, animals, or objects located below the bumper or that are too close or too far from the vehicle. It is not available at speeds greater than 8 km/h (5 mph). To prevent injury, death, or vehicle damage, even with Park Assist, always check the area around the vehicle and check all mirrors before moving forward or backing.

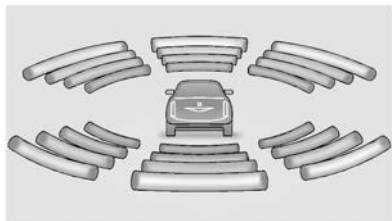

The instrument cluster may have a Park Assist display with bars that show “distance to object” and object location information for the Front and Rear Park Assist system. As the object gets closer, more bars light up and the bars change color from yellow to amber to red.

When an object is first detected in the rear, one beep will be heard from the rear, or both sides of the Safety Alert Seat will pulse two times. When an object is very close — <0.4 m (1.5 ft) in the vehicle rear or <0.3 m (1 ft) in the vehicle front — a continuous beep will sound from the rear or front depending on object location, or both sides of the Safety Alert Seat will pulse five times. Beeps for FPA are higher pitched than for RPA.

### Turning the Features On or Off



Press **P** on the center stack to turn on or off the Front and Rear Park Assist. The indicator light next to the button comes on when the features are on and turns off when the features have been disabled.

Front and Rear Park Assist can be turned Off or On. There is also a Park Assist Towbar that can be turned Off or On. To view available settings from the infotainment screen, touch Settings > Vehicle > Collision/ Detection Systems > Park Assist. If Park Assist is turned off through vehicle personalization, the Park Assist button will be disabled. To turn Park Assist on again, select On in vehicle personalization. Setting Park Assist Towbar to On allows Park Assist to work properly with a trailer hitch. Some larger trailer hitches may not be compatible.

Turn off Park Assist when towing a trailer.

### Automatic Parking Assist (APA)

Under certain conditions enhanced Automatic Parking Assist (APA) can use sensors based on sonar technology along the vehicle’s front, rear, and sides to detect a parking spot and automatically park the vehicle. The vehicle will automatically maneuver into a detected spot moving at or near idle speed. It does this by automatically steering, braking, accelerating, and shifting gears. The driver must always be prepared to apply braking if necessary. A display and beeps help to guide the parking maneuvers.

#### Warning

APA may not always detect objects in the parking space, objects that are not rigid (e.g. shrubs and chain-link fences), objects below the bumper, objects high off the ground (e.g. flatbed trucks), hanging objects, objects below ground level (e.g. large potholes), or moving objects (e.g. pedestrians, cyclists, vehicles). Always verify that the parking space is appropriate for parking a vehicle. APA may not respond to changes in the

(Continued)

**Warning (Continued)**

parking space, such as movement of an adjacent vehicle, or a person or object entering the parking space. APA does not detect or avoid traffic that is behind or alongside of the vehicle. Always be prepared to stop the vehicle during the parking maneuver.

**How to Activate Automatic Parking**

To activate APA, press **P** on the center stack for the system to begin searching for a parking space while driving forward at no greater than 30 km/h (18 mph). By default, APA searches for parallel parking spaces to the right of the vehicle up to 1.5 m (5 ft). To search for a parking space to the left, turn on the left turn signal or, if available, change the side selection in the infotainment display. To switch the parking mode between parallel and perpendicular, press and hold **P** while searching for a valid parking spot or, if available, change the parking mode in the infotainment display.

APA cannot park in all empty parking spots. The parking spot must:

- Be sufficiently large to fit the vehicle comfortably.
- Have an adjacent vehicle, wall, or pillar for the system to align to.

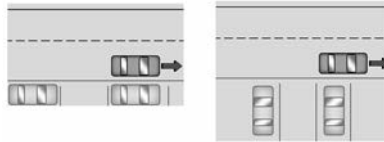

After completely passing an eligible parking spot, a beep sounds and a red stop symbol is displayed in the Driver Information Center (DIC). Generally, APA selects the nearest empty parking spot behind the vehicle, but under some conditions may select a space that is further back. Slow down and bring the vehicle to a complete stop to begin.

Follow the displayed instructions. When prompted, shift to R (Reverse) while holding the brake. The steering wheel will vibrate briefly as a reminder to remove hands from the steering wheel. Release the brake slowly when the vibration stops to begin automatic parking. As the vehicle automatically steers, brakes, accelerates, and shifts gears into the

parking spot, check surroundings. Be prepared to stop to avoid vehicles, pedestrians, or objects.

A progress arrow displays the status of the parking maneuver. Once automatic parking is finished and the vehicle has come to a full stop, FINAL POSITION - PRESS BRAKES message will be displayed. Press and hold the brake, and APA will beep and display a PARKING COMPLETE message. Shift the vehicle to P (Park) and apply the parking brake.

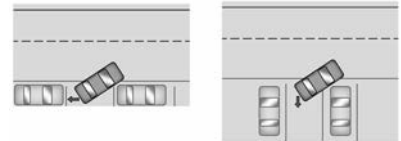
**How to Activate Automatic Parallel Spot Unparking Assist**

To activate parallel spot unparking assist, press the soft-touch button or hard switch **P** after turning on the vehicle while leaving it in P (Park) and the parking brake is off. If the system is able to determine a

path out of the parking spot, a screen will be displayed for unparking options. Similar to automatic parking, follow the displayed instructions and check surroundings as the vehicle unparks.

Once automatic unparking is finished and the vehicle has come to a full stop, a FINAL POSITION - PRESS BRAKES message will be displayed. Press and hold the brake, and APA will beep and display a TAKE CONTROL message. The vehicle is now positioned such that the path to exit the parking spot is free of obstructions. Shift into D (Drive) to start driving away.

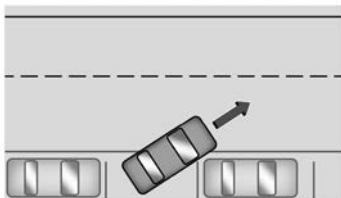

### How to Cancel Automatic Parking or Automatic Unparking

To cancel automatic parking or automatic unparking at any time, press **P** or "X" on the infotainment display and be prepared to

resume control of the vehicle. APA holds the vehicle until the parking brake or brake is applied, or the vehicle is shifted into P (Park). To start driving away, press the brake and shift to D (Drive).

Certain vehicle conditions and driver interferences may also cancel automatic parking:

- The driver manually steers the vehicle.
- The maximum allowed speed is exceeded.
- There is a failure with the APA system.
- Electronic stability control or antilock brakes are activated.
- The parking brake is applied or vehicle is shifted into Park (P).
- The driver unbuckles seat belt and opens a door.

### System Limitations

Automatic Parking Assist has certain limitations. The system cannot:

- Maneuver the vehicle at speeds exceeding 5 km/h (3 mph).
- Detect whether a parking space is legal or restricted.
- Detect pavement markings or lines

- Park the vehicle closely lined up with the vehicle next to it, particularly if the spot is approached at an angle or if the parking space is angled.
- Park exactly centered in a very large spot.
- Always detect short curbs.
- Operate while towing any trailer.
- Function when the vehicle is raised or lowered by air suspension.
- Detect or automatically react to approaching traffic when exiting a parallel spot.
- Function when Active Rear Steering is not in automatic mode.

### When the System Does Not Seem to Work Properly

If the vehicle does not reverse into the expected parking space, the system could be maneuvering the vehicle into a previously detected space.

### Reverse Automatic Braking (RAB)

#### Backing Warning and Reverse Automatic Braking (RAB)

Vehicles with Adaptive Cruise Control (ACC) have the Backing Warning System and Reverse Automatic Braking (RAB) system.

When in R (Reverse), Backing Warning alerts of rear objects at vehicle speeds greater than 8 km/h (5 mph), and RAB may automatically brake hard at speeds between 1-32 km/h (0.5-20 mph).

The Backing Warning System will beep once from the rear when an object is first detected, or pulse twice on both sides of the Safety Alert Seat. When the system detects a potential crash, beeps will be heard from the rear, or five pulses will be felt on both sides of the Safety Alert Seat. There may also be a brief, sharp application of the brakes.

### Warning

The Backing Warning System only operates at speeds greater than 8 km/h (5 mph). It does not detect children, pedestrians, bicyclists, animals, or objects below the bumper or that are too close or too far from the vehicle. In some situations, such as at higher backing speeds, there may not be enough time for the short, sharp application of the vehicle brake system to occur. To prevent injury, death, or vehicle damage, even

(Continued)

### Warning (Continued)

with the Backing Warning System, always check the area around the vehicle and check all mirrors before backing.

When the vehicle is in R (Reverse), if the system detects the vehicle is backing too fast to avoid a crash with a detected object behind your vehicle in your path, it may automatically brake hard to a stop to help avoid or reduce the harm caused by a backing crash.

### Warning

RAB may not avoid many types of backing crashes. Do not wait for the automatic braking to apply. This system is not designed to replace driver braking and only works in R (Reverse) when an object is detected directly behind the vehicle. It may not brake or stop in time to avoid a crash. It will not brake for objects when the vehicle is moving at very low speeds. It does not detect children, pedestrians, bicyclists, animals, or objects below the bumper or that are too close or too far from the vehicle. To

(Continued)

### Warning (Continued)

prevent injury, death, or vehicle damage, even with RAB, always check the area around the vehicle before and while backing.

Pressing the brake pedal after the vehicle comes to a stop will release RAB. If the brake pedal is not pressed soon after the stop, the Electric Parking Brake (EPB) may be set. When it is safe, press the accelerator pedal firmly at any time to override RAB.

### Warning

There may be instances where unexpected or undesired automatic braking occurs. If this happens, either press the brake pedal or firmly press the accelerator pedal to release the brakes from the RAB system. Before releasing the brakes, check the RVC and check the area around the vehicle to make sure it is safe to proceed.

Unexpected braking events are possible with a static installed accessory, such as a bike rack or hitch-mounted cargo carrier.

## Rear Pedestrian Alert

Under certain conditions, this feature can provide alerts for a pedestrian within the system's range directly behind the vehicle. This feature only works in R (Reverse) below 12 km/h (8 mph), and detects pedestrians up to 8 m (26 ft) away during daytime driving. During nighttime driving, feature performance is very limited.



Rear Pedestrian Alert Indicator

When a pedestrian is detected within the system's range directly behind the vehicle, this symbol flashes amber on the infotainment display, along with two beeps from the rear and/or two pulses from both sides of the driver seat. When a pedestrian is detected close to the vehicle, the symbol flashes red on the infotainment display, along with seven beeps from the rear, or if equipped, seven pulses from both sides of the driver seat.

### Warning

Rear Pedestrian Alert does not automatically brake the vehicle. It also does not provide an alert unless it detects a pedestrian, and it may not detect all pedestrians if:

- The pedestrian is not directly behind the vehicle, fully visible to the Rear Vision Camera (RVC), or standing upright.
- The pedestrian is part of a group.
- The pedestrian is a child.
- Visibility is poor, including nighttime conditions, fog, rain, or snow.
- The RVC is blocked by dirt, snow, or ice.
- The RVC, taillamps, or back-up lamps are not cleaned or in proper working condition.
- The vehicle is not in R (Reverse).

To help avoid death or injury, always check for pedestrians around the vehicle before backing up. Be ready to take

(Continued)

### Warning (Continued)

action and apply the brakes. See *Defensive Driving* ⇨ 164. Keep the RVC, taillamps, and back-up lamps clean and in good repair.

Rear Pedestrian Alert can be set to Off or Alert. To view available settings from the infotainment screen, touch Settings > Vehicle > Collision/Detection Systems > Rear Pedestrian Alert. Alerts can be set to beeps or seat pulses. To view available settings from the infotainment screen, touch Settings > Vehicle > Collision/Detection Systems > Alert Type.

## Rear Cross Traffic Alert (RCTA) System

Rear Cross Traffic Alert (RCTA) displays a red warning triangle with a left or right pointing arrow on the infotainment display to warn of traffic coming from the left or right. This system detects objects coming from up to 20 m (65 ft) from the left or right side of the vehicle. When an object is detected, either three beeps sound from the left or

right or three Safety Alert Seat pulses occur on the left or right side, depending on the direction of the detected vehicle.

### Driving With a Trailer

Use caution while backing up when towing a trailer. The RCTA feature is automatically disabled when a trailer is attached to the vehicle.

### Turning the Features On or Off

RCTA can be turned on or off using the infotainment system. To view available settings from the infotainment screen, touch Settings > Vehicle > Collision/Detection Systems.

### Assistance Systems for Driving

If equipped, when driving the vehicle in a forward gear, Forward Collision Alert (FCA), Lane Departure Warning (LDW), Lane Keep Assist (LKA), Side Blind Zone Alert (SBZA), Lane Change Alert (LCA), Automatic Emergency Braking (AEB), and/or the Front Pedestrian Braking (FPB) System can help to avoid a crash or reduce crash damage.

## Forward Collision Alert (FCA) System

The FCA system may help to avoid or reduce the harm caused by front-end crashes. When approaching a vehicle ahead too quickly, FCA provides a red flashing alert on the windshield and rapidly beeps or pulses the driver seat. FCA also lights an amber visual alert if following another vehicle much too closely.

FCA detects vehicles within a distance of approximately 110 m (360 ft) and operates at all speeds.

### Warning

FCA is a warning system and does not apply the brakes. When approaching a slower-moving or stopped vehicle ahead too rapidly, or when following a vehicle too closely, FCA may not provide a warning with enough time to help avoid a crash. It also may not provide any warning at all. FCA does not warn of pedestrians, animals, signs, guardrails, bridges, construction barrels, or other  
(Continued)

### Warning (Continued)

objects. Be ready to take action and apply the brakes. See *Defensive Driving* ⇨ 164.

FCA can be disabled through vehicle personalization. To view available settings from the infotainment screen, touch Settings > Vehicle > Collision/Detection Systems.

### Detecting the Vehicle Ahead



FCA warnings will not occur unless the FCA system detects a vehicle ahead. When a vehicle is detected, the vehicle ahead indicator will display green. Vehicles may not be detected on curves, highway exit ramps, or hills, due to poor visibility; or if a vehicle ahead is partially blocked by pedestrians or other objects. FCA will not detect another vehicle ahead until it is completely in the driving lane.



**Warning**

FCA does not provide a warning to help avoid a crash, unless it detects a vehicle. FCA may not detect a vehicle ahead if the FCA sensor is blocked by dirt, snow, or ice, or if the windshield is damaged. It may also not detect a vehicle on winding or hilly roads, or in conditions that can limit visibility such as fog, rain, or snow, or if the headlamps or windshield are not cleaned or in proper condition. Keep the windshield, headlamps, and FCA sensors clean and in good repair.

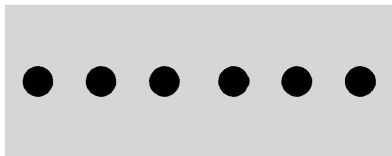
**Collision Alert**

When your vehicle approaches another detected vehicle too rapidly, the red FCA display will flash on the windshield. Also, eight rapid high-pitched beeps will sound from the front, or both sides of the Safety

Alert Seat will pulse five times. When this Collision Alert occurs, the brake system may prepare for driver braking to occur more rapidly which can cause a brief, mild deceleration. Continue to apply the brake pedal as needed.

**Tailgating Alert**

The vehicle ahead indicator will display amber when you are following a vehicle ahead much too closely.

**Selecting the Alert Timing**

The Collision Alert control is on the steering wheel. Press  to set the FCA timing to Far, Medium, or Near. The first button press shows the current setting on the DIC.

Additional button presses will change this setting. The chosen setting will remain until it is changed and will affect the timing of both the Collision Alert and the Tailgating Alert features. The timing of both alerts will vary based on vehicle speed. The faster the vehicle speed, the farther away the alert will occur. Consider traffic and weather conditions when selecting the alert timing. The range of selectable alert timings may not be appropriate for all drivers and driving conditions.

Changing the FCA timing setting automatically changes the Adaptive Cruise Control following gap setting (Far, Medium, or Near).

**Following Distance Indicator**

The following distance to a moving vehicle ahead in your path is indicated in following time in seconds on the Driver Information Center (DIC). The minimum following time is 0.5 seconds away. If there is no vehicle detected ahead, or the vehicle ahead is out of sensor range, dashes will be displayed.

## Unnecessary Alerts

FCA may provide unnecessary alerts for turning vehicles, vehicles in other lanes, objects that are not vehicles, or shadows. These alerts are normal operation and the vehicle does not need service.

## Cleaning the System

If the FCA system does not seem to operate properly, this may correct the issue:

- Clean the outside of the windshield in front of the rearview mirror.
- Clean the entire front of the vehicle.
- Clean the headlamps.

## Automatic Emergency Braking (AEB)

The AEB system may help avoid or reduce the harm caused by front-end crashes. AEB also includes Intelligent Brake Assist (IBA). When the system detects a vehicle ahead in your path that is traveling in the same direction that you may be about to crash into, it can provide a boost to braking or automatically brake the vehicle. This can help avoid or lessen the severity of crashes when driving in a forward gear. Depending on the situation, the vehicle may

automatically brake moderately or hard. This automatic emergency braking can only occur if a vehicle is detected. This is shown by the FCA vehicle ahead indicator being lit. See *Forward Collision Alert (FCA) System* ⇨ 243.

The system works when driving in a forward gear above 4 km/h (2 mph). It can detect vehicles up to approximately 60 m (197 ft).

### Warning

AEB is an emergency crash preparation feature and is not designed to avoid crashes. Do not rely on AEB to brake the vehicle. AEB will not brake outside of its operating speed range and only responds to detected vehicles.

AEB may not:

- Detect a vehicle ahead on winding or hilly roads.
- Detect all vehicles, especially vehicles with a trailer, tractors, muddy vehicles, etc.
- Detect a vehicle when weather limits visibility, such as in fog, rain, or snow.

(Continued)

### Warning (Continued)

- Detect a vehicle ahead if it is partially blocked by pedestrians or other objects.

Complete attention is always required while driving, and you should be ready to take action and apply the brakes and/or steer the vehicle to avoid crashes.

AEB may slow the vehicle to a complete stop to try to avoid a potential crash. If this happens, AEB may engage the Electric Parking Brake (EPB) to hold the vehicle at a stop. Release the EPB or firmly press the accelerator pedal.

### Warning

AEB may automatically brake the vehicle suddenly in situations where it is unexpected and undesired. It could respond to a turning vehicle ahead, guardrails, signs, and other non-moving objects. To override AEB, firmly press the accelerator pedal, if it is safe to do so.

### Intelligent Brake Assist (IBA)

IBA may activate when the brake pedal is applied quickly by providing a boost to braking based on the speed of approach and distance to a vehicle ahead.

Minor brake pedal pulsations or pedal movement during this time is normal and the brake pedal should continue to be applied as needed. IBA will automatically disengage only when the brake pedal is released.

 **Warning**

IBA may increase vehicle braking in situations when it may not be necessary. You could block the flow of traffic. If this occurs, take your foot off the brake pedal and then apply the brakes as needed.

 **Warning**

Using AEB or IBA while towing a trailer could cause you to lose control of the vehicle and crash. Turn the system to Alert or Off when towing a trailer.

AEB and IBA can be disabled. To view available settings from the infotainment screen, touch Settings > Vehicle > Collision/ Detection Systems.

A system unavailable message may display if:

- The front of the vehicle or windshield is not clean.
- Heavy rain or snow is interfering with object detection.
- There is a problem with the StabiliTrak/ Electronic Stability Control (ESC) system.

The AEB system does not need service.

### Front Pedestrian Braking (FPB) System

The FPB system may help avoid or reduce the harm caused by front-end crashes with nearby pedestrians when driving in a forward gear. FPB displays an amber indicator, , when a nearby pedestrian is detected ahead. When approaching a detected pedestrian too quickly, FPB provides a red flashing alert on the windshield and rapidly beeps or pulses the driver seat. FPB can provide a boost to braking or automatically brake the vehicle. This system includes Intelligent Brake Assist

(IBA), and the Automatic Emergency Braking (AEB) system may also respond to pedestrians. See *Automatic Emergency Braking (AEB)* ⇨ 245.

The FPB system can detect and alert to pedestrians in a forward gear at speeds between 8 km/h (5 mph) and 80 km/h (50 mph). During daytime driving, the system detects pedestrians up to a distance of approximately 40 m (131 ft). During nighttime driving, system performance is very limited.

 **Warning**

FPB does not provide an alert or automatically brake the vehicle, unless it detects a pedestrian. FPB may not detect pedestrians, including children:

- When the pedestrian is not directly ahead, fully visible, or standing upright, or when part of a group.
- Due to poor visibility, including nighttime conditions, fog, rain, or snow.
- If the FPB sensor is blocked by dirt, snow, or ice.

(Continued)

**Warning (Continued)**

- If the headlamps or windshield are not cleaned or in proper condition.

Be ready to take action and apply the brakes. For more information, see *Defensive Driving* ⇨ 164. Keep the windshield, headlamps, and FPB sensor clean and in good repair.

FPB can be set to Off, Alert, or Alert and Brake through vehicle personalization. To view available settings from the infotainment screen, touch Settings > Vehicle > Collision/Detection Systems.

**Detecting the Pedestrian Ahead**

FPB alerts and automatic braking will not occur unless the FPB system detects a pedestrian. When a pedestrian that may enter the vehicle's forward path is detected, the pedestrian ahead indicator will display amber.

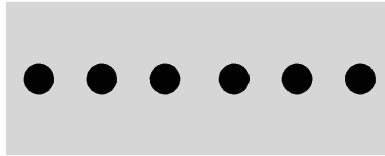
**Front Pedestrian Alert**

When the vehicle approaches a pedestrian ahead too rapidly, the red FPB alert display will flash on the windshield. Eight rapid high-pitched beeps will sound from the front, or both sides of the Safety Alert Seat will pulse five times. When this Pedestrian Alert occurs, the brake system may prepare for driver braking to occur more rapidly which can cause a brief, mild deceleration. Continue to apply the brake pedal as needed. Cruise control may be disengaged when the Front Pedestrian Alert occurs.

**Automatic Braking**

If FPB detects it is about to crash into a pedestrian directly ahead, and the brakes have not been applied, FPB may automatically brake moderately or brake hard. This can help to avoid some very low speed pedestrian crashes or reduce pedestrian injury. FPB can automatically brake to detected pedestrians between

8 km/h (5 mph) and 80 km/h (50 mph). Automatic braking levels may be reduced under certain conditions, such as higher speeds.

FPB may slow the vehicle to a complete stop to try and avoid a potential collision with a pedestrian. If this happens, Automatic Braking may engage the Electric Parking Brake (EPB) to hold the vehicle at a stop. Release the EPB. A firm press of the accelerator pedal will also release Automatic Braking and the EPB.

**Warning**

FPB may alert or automatically brake the vehicle suddenly in situations where it is unexpected and undesired. It could falsely alert or brake for objects similar in shape or size to pedestrians, including shadows. This is normal operation and the vehicle does not need service. To override Automatic Braking, firmly press the accelerator pedal, if it is safe to do so.

Automatic Braking can be disabled through vehicle personalization. To view available settings from the infotainment screen, touch Settings > Vehicle > Collision/Detection Systems > Front Pedestrian Braking.

**Warning**

Using the Front Pedestrian Braking system while towing a trailer could cause you to lose control of the vehicle and crash. Turn the system to Alert or Off when towing a trailer.

**Cleaning the System**

If FPB does not seem to operate properly, cleaning the outside of the windshield in front of the rearview mirror may correct the issue.

**Side Blind Zone Alert (SBZA)**

The SBZA system is a lane-changing aid that assists drivers with avoiding crashes that occur with moving vehicles in the side blind zone, or blind spot areas. When the vehicle is in a forward gear, the left or right side mirror display will light up if a moving vehicle is detected in that blind zone. If the turn signal is activated and a vehicle is also detected on the same side, the display will flash as an extra warning not to change lanes. Since this system is part of the Lane Change Alert (LCA) system, read the entire LCA section before using this feature.

**Lane Change Alert (LCA)**

If equipped, the Lane Change Alert (LCA) system is a lane-changing aid that can assist drivers with avoiding lane change crashes with moving vehicles in the side blind zone, or blind spot areas or with vehicles rapidly approaching these areas from behind. When a vehicle is detected in the blind zone, the LCA warning display will light up in the corresponding side mirror and will flash if the turn signal is on. The Side Blind Zone Alert (SBZA) system is included as part of the LCA system.

**Warning**

LCA does not alert the driver to vehicles outside of the system detection zones, pedestrians, bicyclists, or animals. It may not provide alerts when changing lanes under all driving conditions. Failure to use proper care when changing lanes may result in injury, death, or vehicle damage. Before making a lane change, always check mirrors, glance over your shoulder, and use the turn signals.

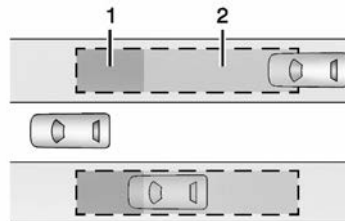
**LCA Detection Zones**

1. SBZA Detection Zone
2. LCA Detection Zone

When towing a trailer, LCA feature is disabled. When not towing a trailer, the LCA sensor covers a zone of approximately one lane over from both sides of the vehicle, or 3.5 m (11 ft). The height of the zone is approximately between 0.5 m (1.5 ft) and 2 m (6 ft) off the ground. Drivers are also warned of vehicles rapidly approaching this area up to approximately 70 m (230 ft) behind the vehicle.

**Trailer Side Blind Zone Area (TSBZA)**

If equipped, the TSBZA system is a lane-changing aid that assists drivers with avoiding crashes that occur with moving vehicles in the side blind zone, or blind spot

areas. The trailer side blind zone area adds the blind zone area along the side of a trailer that the host vehicle is pulling.

When the vehicle is in a forward gear, the left or right side mirror display will light up if a moving vehicle is detected in that trailer blind zone. If the turn signal is activated and a vehicle is also detected on the same side, the display will flash as an extra warning not to change lanes. Since this system is part of the Lane Change Alert system, read the entire Lane Change Alert section before using this feature.

### Warning

TSBZA does not alert the driver to vehicles outside of the system detection zones, pedestrians, bicyclists, or animals. It may not provide alerts when changing lanes under all driving conditions. Failure to use proper care when changing lanes may result in injury, death, or vehicle damage. Before making a lane change, always check mirrors, glance over your shoulder, and use the turn signals.

### TSBZA Detection Zones

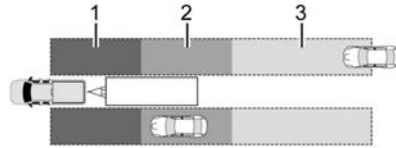

1. SBZA Detection Zone
2. TSBZA Detection Zone
3. LCA Detection Zone

The Side Blind Zone Alert (SBZA) warning area starts at approximately the middle of the vehicle and goes back 5 m (16 ft). The Trailer Side Blind Zone Alert (TSBZA) warning area starts at approximately 3 m (10 ft) to the trailing edge of the vehicle and goes back up to 21 m (69 ft) behind the vehicle. The maximum trailer length is 9 m (29 ft).

### How the System Works

The LCA/TSBZA symbol lights up in the side mirrors when the system detects a moving vehicle in the next lane over that is in the trailer side blind zone. This indicates it may be unsafe to change lanes. Before making a lane change, check the SBZA display, check mirrors, glance over your shoulder, and use the turn signals.



Left Side Mirror  
Display



Right Side Mirror  
Display

When the vehicle is started, both outside mirror LCA/TSBZA displays will briefly come on to indicate the system is operating. When the vehicle is in a forward gear, the left- or right-side mirror display will light up if a moving vehicle is detected in that blind zone. If the turn signal is activated in the same direction as a detected vehicle, this display will flash as an extra warning not to change lanes.

LCA/TSBZA displays may not come on when passing a vehicle quickly, or when passing a stopped vehicle. LCA/TSBZA may alert to objects attached to the vehicle, such as a bicycle, or object extending out to either side of the vehicle or trailer. This is normal system operation; the vehicle does not need service.

LCA/TSBZA can be disabled through vehicle settings. To view available settings from the infotainment screen, touch Settings > Vehicle > Collision/Detection Systems. If SBZA is disabled by the driver, the TSBZA mirror displays will not light up.

### When the System Does Not Seem to Work Properly

LCA/TSBZA displays may not come on when passing a vehicle quickly, or when passing a stopped vehicle. The LCA/TSBZA detection zones that extend back from the side of the vehicle do not move further back when a trailer is towed. Use caution while changing lanes when towing a trailer. LCA/TSBZA may alert to objects attached to the vehicle, such as a trailer, bicycle, or object extending out to either side of the vehicle or trailer. This is normal system operation; the vehicle does not need service.

LCA/TSBZA may not always alert the driver to vehicles in the side blind zone, especially in wet conditions. The system does not need to be serviced. The system may light up due to guardrails, signs, trees, shrubs, and other non-moving objects. This is normal system operation; the vehicle does not need service.

LCA/TSBZA may not operate when the LCA/TSBZA sensors in the left or right corners of the rear bumper are covered with mud, dirt, snow, ice, or slush, or in heavy rainstorms. For cleaning instructions, see "Washing the Vehicle" under *Exterior Care* ⇨ 349. If the DIC displays the system unavailable message after cleaning both sides of the vehicle toward the rear corners of the vehicle, see your dealer.

If the DIC displays the system unavailable message after cleaning both sides of the vehicle toward the rear corners of the vehicle, see your dealer

If the LCA/TSBZA displays do not light up when vehicles are in the blind zone and the system is clean, the system may need service. Take the vehicle to your dealer.

When TSBZA is disabled for any reason other than the driver turning it off, the Trailer Side Blind Zone Alert On option will not be available on the settings menu.

### Driving with a Trailer

Although this system is intended to help drivers avoid lane change crashes, it does not replace driver vision and therefore should be considered a lane change aid. Even with the TSBZA system, the driver

must check carefully for objects outside of the reporting zone (e.g., a fast approaching vehicle) or vehicle along the side of the trailer before changing lanes.

Use caution while changing lanes when towing a trailer.

### Lane Keep Assist (LKA)

If equipped, LKA may help avoid crashes due to unintentional lane departures. This system uses a camera to detect lane markings. The LKA system can be ready to assist at speeds between approximately 60 km/h (37 mph) and 180 km/h (112 mph). On some vehicles, the system will instead operate above 50 km/h (31 mph). LKA may assist by gently turning the steering wheel if the vehicle approaches a detected lane marking. It may also provide a Lane Departure Warning (LDW) alert if the vehicle unintentionally crosses a detected lane marking.

The LKA system is not intended to keep the vehicle centered in the lane. LKA will not assist or alert if the turn signal is active, or if it detects that you are accelerating, braking, or actively steering. LKA can be overridden by turning the steering wheel. If the system detects you are steering

intentionally across a lane marker, the LDW alert may not be given. Do not expect the LDW alert to occur when you are intentionally crossing the lane marker.

### Warning

The LKA system does not continuously steer the vehicle. It may not keep the vehicle in the lane or give a Lane Departure Warning (LDW) alert, even if a lane marking is detected.

The LKA and LDW systems may not:

- Provide an alert or enough steering assist to avoid a lane departure or crash.
- Detect lane markings under poor weather or visibility conditions. This can occur if the windshield or headlamps are blocked by dirt, snow, or ice; if they are not in proper condition; or if the sun shines directly into the camera.
- Detect road edges.
- Detect lanes on winding or hilly roads.

(Continued)

### Warning (Continued)

If LKA only detects lane markings on one side of the road, it will only assist or provide an LDW alert when approaching the lane on the side where it has detected a lane marking. Even with LKA and LDW, you must steer the vehicle. Always keep your attention on the road and maintain proper vehicle position within the lane, or vehicle damage, injury, or death could occur. Always keep the windshield, headlamps, and camera sensors clean and in good repair. Do not use LKA in bad weather conditions or on roads with unclear lane markings, such as construction zones.

### Warning

Using LKA on slippery roads could cause loss of control of the vehicle and a crash. Turn the system off.

### Warning

LKA will not alert the driver if a towed trailer crosses into an adjacent lane of travel. Serious injury or property damage may occur if the trailer moves into another lane. Always monitor the trailer position while towing to make sure it is within the same lane as the tow vehicle.

### How the System Works

LKA uses a camera sensor installed on the windshield ahead of the rearview mirror to detect lane markings. It may provide brief steering assist if it detects an unintended lane departure. It may further provide an audible alert or the driver seat may pulse indicating that a lane marking has been crossed. The system does not provide an LDW when intentionally steering across a lane marker.





To turn LKA on and off, press  on the instrument panel to the left of the steering wheel. If equipped, the indicator light on the button comes on when LKA is on and turns off when LKA is disabled. In some vehicles, you must press the button for more than three seconds to turn LKA off.



LKA is not available when Terrain Mode, Snow/Ice Mode, Off-Road, or CrabWalk Mode is selected.

See *Driver Mode Control* ⇨ 194. See *Four-Wheel Steering (Including Crabwalk)* ⇨ 196.

When attempting to enable LKA in any of the above conditions, LKA UNAVAILABLE will display.

When on,  is white, if equipped, indicating that the system is not ready to assist.  is green if LKA is ready to assist. LKA may assist by gently turning the steering wheel if the vehicle approaches a detected lane marking.  is amber when assisting. It may also provide a Lane Departure Warning (LDW) alert by flashing  amber if the vehicle crosses a detected lane marking. Additionally, there may be three beeps, or the driver seat may pulse three times, on the right or left, depending on the lane departure direction.

### Take Steering

The LKA system does not continuously steer the vehicle. If LKA does not detect active driver steering, an alert and chime may be

provided. Steer the vehicle to dismiss. LKA may become temporarily unavailable after repeated take steering alerts.



If your vehicle is equipped with Super Cruise or Lane Centering Assistance, hold the steering wheel in the areas shown to help prevent unwarranted take steering alerts.

### When the System Does Not Seem to Work Properly

The system performance may be affected by:

- Close vehicles ahead.
- Sudden lighting changes, such as when driving through tunnels.
- Banked roads.

- Roads with poor lane markings, such as two-lane roads.

If the LKA system is not functioning properly when lane markings are clearly visible, cleaning the windshield may help.

A camera blocked message may display if the camera is blocked. Some driver assistance systems may have reduced performance or not work at all. An LKA or LDW unavailable message may display if the systems are temporarily unavailable. This message could be due to a blocked camera. The LKA system does not need service. Clean the outside of the windshield behind the rearview mirror.

LKA assistance and/or LDW alerts may occur due to tar marks, shadows, cracks in the road, temporary or construction lane markings, or other road imperfections. This is normal system operation; the vehicle does not need service. Turn LKA off if these conditions continue.

## Charging

### When to Charge

When the high voltage battery is low, the following charging messages may display on the Driver Information Center (DIC):

**CHARGE VEHICLE SOON** : The battery needs to be charged soon.

**REDUCED ACCELERATION DRIVE WITH CARE** : The accelerator pedal response is reduced and the remaining range value changes to LOW, charge the vehicle immediately.

**OUT OF ENERGY, CHARGE VEHICLE NOW** : The battery charge is fully depleted. The vehicle will slow to a stop. Brake and steering assist will continue operating. Once stopped, turn the vehicle off. See *Propulsion Power Messages* ⇨ 118.

### Plug-In Charging

Plug-in charge times vary based on the battery condition, charge level, outside temperatures, and charge station capability. See *Charging* ⇨ 109 for charge mode selection.

Do not allow the vehicle to remain in temperature extremes for long periods without being driven or plugged in. When temperatures are below 0 °C (32 °F) and above 32 °C (90 °F), plug in the vehicle to maximize high voltage battery life.

In extreme temperature conditions, a full charge will take additional time.

It is normal to hear fans, pumps, and electrical devices clicking while the vehicle is turned off and charging.

The vehicle does not require indoor charging area ventilation before, during, or after charging.

The vehicle cannot be driven while the charge cord is plugged into the vehicle.

#### Caution

To avoid damage to the vehicle, make sure the charging cord plug is in good condition, is not worn or damaged, and is connected securely to the vehicle's charging port. If vehicle charging is intermittent, disconnect the cord and inspect for damage. An excessively worn or damaged AC or DC charging cord plug

(Continued)

#### Caution (Continued)

may result in an intermittent connection and potential damage to the vehicle's charging port.

There are several infotainment screens that will display depending on the current charging status. See *Charging* ⇨ 109.

### Charging Override

A CHARGING OVERRIDE/INTERRUPTION OCCURRED message may display to indicate that a charging override or interruption has occurred due to one or more of the following events:

- Override of the charge settings by the owner.
- Unintended interruption of AC power at the vehicle charge port.
- Interruption of charging by the utility company.

### AC Charging

A loss of AC power alert may sound for a short time if AC power is lost for over one minute. This sound alert can be turned off. See *Charging* ⇨ 109.



AC Charge Cord Vehicle Plug

### To Start AC Charging

1. Put the vehicle in P (Park).



2. The charge port door is on the rear driver side of the vehicle. Push the rearward edge of the charge port door and release to open.

In cold weather conditions, ice may form around the charge port door. Remove ice from the area before attempting to open or close the charge port door.

3. Plug the charge cord into the electrical outlet. To verify the charge cord status, see *Electrical Requirements for Battery Charging* ⇨ 262 and *Charge Cord* ⇨ 259. For instructions to set cord limit settings for a charge session, see *Charging* ⇨ 109.



4. Plug in the AC charge cord into the vehicle charge port. Make sure the AC charge cord is fully connected to the AC charge port. If it is not properly connected, the vehicle may not be charged.

5. Verify that the headlight Charging Status Indicator (CSI) illuminates on the headlamps (if enabled), charge port light turns on, and an audible chirp occurs. See *Charging Status Feedback* ⇨ 257.

### To End AC Charging

1. Unlock the charge cord from the vehicle by pressing the button on the top of the charge cord plug. Unplug the charge cord from the vehicle.
2. Close the charge port door by pressing firmly in the center until it latches.
3. Unplug the charge cord from the electrical outlet.
4. Place the charge cord into the storage case.

### DC Charging

#### DC Charging Station Hardware

The vehicle can be charged using DC charging equipment typically found at service stations and other public locations.

Check the charging station DC charge cord for compatibility with the DC charge port on this vehicle. This vehicle is compatible with a Combined Charging System 1 (CCS1) connector.

When recharging at a DC charge station, the charging cable connected to the vehicle must be less than 10 m (33 ft) in length to meet functionality and regulatory requirements.

Follow the steps listed on the charging station to perform a DC vehicle charge.

If for any reason DC charging does not begin or is interrupted, check the DC charging station display for messages. Unplug the cord to restart the DC charging process. If charging issue persist, drive the vehicle to an adjacent or nearest charge station. Do not pull neighboring charge station cords to vehicle.

### To Start DC Charging

1. Put the vehicle in P (Park).
2. Press the Electric Parking Brake (EPB) switch. See *Electric Parking Brake* ⇨ 189.
3. Push the rearward edge of the charge port door and release to open the door.

In cold weather conditions, ice may form around the charge port door. The charge port door may not open on the first attempt. Remove ice from the area and repeat attempting to open the charge port door.



4. Unlatch the DC charging dust cover and push it to the side.



5. Plug in the DC charge cord into the vehicle charge port. Make sure that the DC charge cord is fully connected to the

DC charge port. If it is not properly connected, the vehicle may not be charged. Check the Driver Information Center (DIC) to make sure the charge cord is connected properly.

6. Follow the steps listed on the charging station to start charging.
7. When charging is active, the DC charge cord is locked to the DC charge port and cannot be disconnected.
8. Verify that the headlight Charging Status Indicator (CSI) illuminates on the headlamps (if enabled), charge port light turns on, and an audible chirp occurs. See *Charging Status Feedback* ⇨ 257.

### Caution

Do not attempt to disconnect the DC vehicle plug while charging is active. This action may damage the vehicle or charging station hardware.

### To Stop DC Charging – Automatic

When the vehicle no longer needs power from the charging station, it stops charging and the DC charge cord unlocks from the DC charge port.

Energy can still be consumed from the charging station when the vehicle displays and indicators show that the battery is fully charged. This is to ensure the battery is in optimal temperature operating range to maximize vehicle range. See *Charging* ⇨ 109.

### To End DC Charging

1. Wait until the charging process has fully stopped, the DC charge cord is unlocked, and the charging status indicator is solid green or off. To stop charging at any time during the charge process, see “To Stop AC or DC Charging” later on in this section.

If the charge cord does not unlock from the vehicle charge port after a charge, contact Roadside Assistance. See *Roadside Assistance Program* ⇨ 369.

2. Unplug the DC charge cord from the DC charge port on the vehicle and close the dust cover.
3. Close the charge port door by pressing firmly in the center until it latches.
4. Manually disengage the Electric Parking Brake (EPB) before driving the vehicle.

### Emergency Manual Charge Cord Release

The charging inlet port is equipped with an emergency manual charge cord release in the event the charge cord cannot be released normally while DC charging.

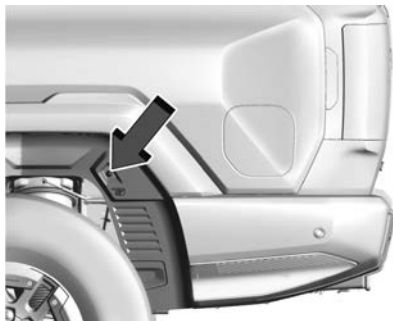

1. Reach around the panel to find the emergency manual charge cord release.



2. Pull the emergency manual charge cord release handle. The DC charge cord will release.

### To Stop AC or DC Charging

Controls on the charging station can be used to stop the charge process at any time.

To stop charging when inside the vehicle, use the Stop Charge button on the Charging screen. See “Active Charging” under *Charging* ⇨ 109.

## Delayed Charging Override

To temporarily override a delayed charge event, unplug the charge cord from the charge port and then plug it back in within five seconds. A single audible chirp will sound and charging will begin immediately.

To cancel a temporary override, unplug the charge cord, wait for 10 seconds, and then plug the charge cord back in. A double audible chirp will sound and charging will be delayed.

See *Charging* ⇨ 109 for advanced charge scheduling options.

## Charging Status Feedback

The vehicle is equipped with a charge port light and a headlight Charge Status Indicator (CSI).



When the charge cord is plugged in, a color appears to indicate the charging status.

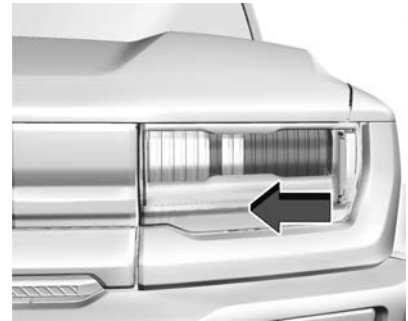

The headlight CSI bar is located on the headlamps. As charging occurs, the blue light bars on the headlamps fill towards the center of the vehicle.

Refer to the table for charging status feedback:

## 258 Driving and Operating

Charge Port Light Color	Headlight Charge Status Indicator	Sound	Action/Reason
Solid Blue	–	–	Initial connection is successful.
Pulsing Blue	Single light bar flashing	Two audible chirps	Charging is delayed by charging screen or by a total utility interruption. Charging will begin later. See <i>Utility Interruption of Charging</i> ⇨ 261. <i>Utility Override</i> (“Demand Response”).
Blinking Green (the longer the blink, the higher the state of charge)	Solid light bars represent the available state of charge. The remaining light bars build in a swipe pattern towards the center of the vehicle.	One audible chirps	Vehicle is actively charging.
Solid Green	All light bars are solid	None	Charging is complete.
Blinking Red	Off	None	Error Check the charge cord connection. There may be no power supplied to the vehicle.
None (upon plug-in)	None	None	Check the charge cord connection.
None (after blue and green lights up)	None	None	Check the charge cord connection. If the connection is good, this may indicate a power failure or a total utility interruption, and charging will begin later. It may also occur if a high voltage charging system fault is detected. See <i>Utility Interruption of Charging</i> ⇨ 261 or <i>Service Vehicle Soon Light (Propulsion System Failure)</i> ⇨ 102.

Charge Port Light Color	Headlight Charge Status Indicator	Sound	Action/Reason
None	None	Three audible chirps when the driver is opened	The charge port door is open.

Once charging is completed and all the blue light bars are filled on the headlamps, they will remain lit for five minutes and then turn off.

To turn off the Headlight CSI light bars, see "Charging Settings" section under *Charging* ⇨ 109.

## Charge Cord

### IMPORTANT SAFETY INSTRUCTIONS



This symbol indicates risk of electrical shock.  
See *Radio Frequency Statement* ⇨ 374.

The vehicle comes with a portable charge cord used to charge the high voltage battery.



1. 240 Volt Wall Plug (120 Volt Plug Similar)
2. Charge Cord Status Indicator
3. Vehicle Plug Latch
4. Release Button

### Important Information about Portable Electric Vehicle Charging

- Charging an electric vehicle can stress a building's electrical system more than a typical household appliance.
- Before plugging the charge cord into any electrical outlet, have a qualified electrician inspect and verify the electrical system (electrical outlet, wiring, junctions, and protection devices) is suitable for a heavy-duty service at a 12 amp continuous load.
- Electrical outlets may wear out with normal usage or may be damaged over time, making them unsuitable for electric vehicle charging.
- Check the electrical outlet/plug while charging and discontinue use if the electrical outlet/plug is hot, then have the electrical outlet serviced by a qualified electrician.



- When outdoors, plug into an electrical outlet that is weatherproof while in use.
- Mount the charge cord to reduce strain on the electrical outlet/plug.
- Do not place the charge cord in a position where it may be submerged in water.

 **Danger**

Improper use of portable electric vehicle charge cords may cause a fire, electrical shock, or burns, and may result in damage to property, serious injury, or death.

- Do not use extension cords, multi-outlet power strips, splitters, grounding adapters, surge protectors, or similar devices.
- Do not use an electrical outlet that is worn or damaged, or will not hold the plug firmly in place.
- Do not use an electrical outlet that is not properly grounded.
- Do not use an electrical outlet that is on a circuit with other electrical loads.

 **Warning**

When using electric products, basic precautions should always be followed, including the following:

- Read all the safety warnings and instructions before using this product. Failure to follow the warnings and the instructions may result in electric shock, fire, and/or serious injury.
- Never leave children unattended near the vehicle while the vehicle is charging and never allow children to play with the charge cord.
- If the plug provided does not fit the electrical outlet, do not modify the plug. Arrange for a qualified electrician to inspect the electrical outlet.
- Do not put fingers into the electric vehicle connector.

 **Warning**

- To reduce the risk of fire, installations shall comply with the requirements of National Electric Code, ANSI/NFPA 70 (USA), Canadian Electrical Code CSA

(Continued)

**Warning (Continued)**

22.1 and IEC 60364 – Electrical installations in buildings, depending on the region in which the unit is being installed. The installer shall comply with any additional local requirements mandated by the country and/or municipality.

- Do not use this product if the flexible power cord or the electric vehicle cable is frayed, has broken insulation, or shows any other signs of damage.
- For Canada only: Not for use in commercial garages.
- Do not use this product if the enclosure or the vehicle plug is broken, cracked, open, or shows any other indication of damage.
- The plug must be plugged into an appropriate electrical outlet that is properly installed in accordance with all local codes and ordinances. Do not modify the plug provided with the product. If the plug does not fit the electrical outlet, have a proper electrical outlet installed by a qualified electrician. If ground is missing, the

(Continued)

**Warning (Continued)**

charge cord indicators will indicate an electrical system fault and the vehicle may not charge.

**Charge Cord Status Indicator**

After plugging in the charge cord, it will perform a quick self test.

Verify the charge cord status. The charge cord uses a combination of red, blue, and yellow indicators to display the status of the charge cord.

If the status indicator is not lit, ensure the electrical outlet has power.

**Charge Level Selection**

Charge level selection can be made using the Charging tab in the Energy Application on the infotainment display. For instructions to set cord limit settings for a charge session, see *Charging* ⇨ 109.

**⚠ Warning**

Using a charge level that exceeds the electrical circuit or electrical outlet capacity may start a fire or damage the electrical circuit. Use the lowest charge level until a qualified electrician inspects the electrical circuit capacity. Use the lowest charge level if the electrical circuit or electrical outlet capacity is not known.

**Grounding Instructions**

The charge circuit must be grounded. If the charge circuit should malfunction or break down, grounding provides a path of least resistance for the electric current to reduce the risk of electric shock. This product is equipped with a cord that has an equipment grounding conductor and a grounding plug. The plug must be plugged into an appropriate outlet that is properly installed and grounded in accordance with all local codes and ordinances.

**⚠ Warning**

Improper connection of the charge cord ground may cause electrical shock. Check with a qualified electrician if there is doubt as to whether the charge circuit is properly grounded. Do not modify the plug provided with the product. If it will not fit the electrical outlet, have a proper electrical outlet installed by a qualified electrician.

**Utility Interruption of Charging**

This vehicle responds to requests through the utility company to limit or completely block electrical power grid use. This feature is inactive during DC charging. A utility interruption will lengthen the vehicle charge time.

When electrical grid power is completely blocked, the vehicle will not charge until the utility interruption has expired. The vehicle should be left plugged in so that the vehicle will automatically resume charging.

Changing the charge mode to Charge Now or performing a delayed charging override will not disable a utility interruption.

A message will display on the instrument cluster indicating that a utility interruption has occurred.

### Charging Station Troubleshooting

If the vehicle does not charge after being plugged in to a residential 240-volt charging station:

1. Verify that the charge mode is set to Charge Now.
2. Verify that the charging station circuit breaker is not tripped.
3. Plug the portable charge cord into the wall outlet, verify that the indicator light on the charge cord is solid green, and connect it to the vehicle. See “Charge Cord Status Indicators” in *Charge Cord* ⇨ 259.
4. If the vehicle charges with the portable charge cord and a different 240-volt charging station, such as a public station, there may be a problem with the charging station. Contact the charging station manufacturer for service.

### Electrical Requirements for Battery Charging

This vehicle is compatible with most standard vehicle charging equipment that complies with one or more of the following standards:

- SAE J1772
- SAE J2847-2
- IEC 61851-1
- IEC 61851-22
- IEC 61851-23
- IEC 61851-24
- IEC 62196-1
- IEC 62196-2
- IEC 62196-3
- ISO 15118

The portable charge cord defaults to 120 volts and 8 amps. Have the outlet inspected before changing to 12 amps on the Charging Screens. If 12 amps is selected, a pop-up will show on the infotainment display to confirm the change to 12 amps. See the “Active Charging” section under *Charging* ⇨ 109.

### Caution

Do not use portable or stationary backup generating equipment to charge the vehicle. This may cause damage to the vehicle's charging system. Only charge the vehicle from utility supplied power.

## Trailer Towing

### General Towing Information

Only use towing equipment that has been designed for the vehicle. Contact your dealer or trailering dealer for assistance with preparing the vehicle to tow a trailer. Read the entire section before towing a trailer.

To tow a disabled vehicle, see *Transporting a Disabled Vehicle* ⇨ 347. To tow the vehicle behind another vehicle such as a motor home, see *Recreational Vehicle Towing* ⇨ 349.

## Driving Characteristics and Towing Tips

### Warning

You can lose control when towing a trailer if the correct equipment is not used or the vehicle is not driven properly. For example, if the trailer is too heavy or the trailer brakes are inadequate for the load, the vehicle may not stop as expected. You and others could be seriously injured. The vehicle may also be damaged, and the repairs would not be covered by the vehicle warranty. Pull a trailer only if all the steps in this section have been followed. Ask your dealer for advice and information about towing a trailer with the vehicle.

### Driving with a Trailer

Trailer driving is different than just driving the vehicle by itself. Trailer driving affects handling, acceleration, braking, and durability. Successful and safe trailer driving requires proper use of the correct equipment.

The following information has many time-tested, important trailer driving tips and safety rules. Many of these are important for your safety and that of your passengers. Read this section carefully before towing a trailer.

When towing a trailer:

- Become familiar with, and follow all state and local laws that apply to trailer towing. These requirements vary from state to state.
- State laws may require the use of extended side view mirrors. If your visibility is limited or restricted while towing, install extended side view mirrors on your vehicle, even if not required.
- Do not tow a trailer during the first 800 km (500 mi) of vehicle use to prevent damage to vehicle.
- Do not drive over 80 km/h (50 mph) and do not make starts at full throttle during the first 800 km (500 mi) of trailer towing.
- Tow in D (Drive). Tow/Haul Mode is recommended for heavier trailers. See *Driver Mode Control* ⇨ 194.

If equipped, the following driver assistance features should be turned off when towing a trailer:

- Park Assist
- Automatic Parking Assist (APA)
- Reverse Automatic Braking (RAB)

If equipped, the following driver assistance features should be turned to alert or off when towing a trailer, unless equipped with Super Cruise:

- Automatic Emergency Braking (AEB)
- Front Pedestrian Braking (FPB)

If equipped with Lane Change Alert (LCA), the LCA detection zones that extend back from the side of the vehicle do not move further back when a trailer is towed. Use caution while changing lanes when towing a trailer.

If equipped, the Rear Cross Traffic Alert (RCTA) feature is automatically disabled when a trailer is attached to the vehicle.

Towing a trailer requires experience. The combination of the vehicle and trailer is longer and not as responsive as the vehicle itself. Become familiar with handling and braking of the combination by driving on a level road surface before driving on public roads.

The trailer structure, the tires, and the brakes must all be rated to carry the intended cargo. Inadequate trailer equipment can cause the combination to operate in an unexpected or unsafe manner. Before driving, inspect all trailer hitch parts and attachments, safety chains, electrical connectors, lamps, tires, and mirrors. See *Towing Equipment* ⇨ 270. If the trailer has electric brakes, start the combination moving and then manually apply the trailer brake controller to check the trailer brakes work. During the trip, occasionally check that the cargo and trailer are secure and that the lamps and any trailer brakes are working.

### **Towing with a Stability Control System**

When towing, the stability control system might be heard. The system reacts to vehicle movement caused by the trailer, which mainly occurs during cornering. This is normal when towing heavier trailers.

### **Following Distance**

Stay at least twice as far behind the vehicle ahead as you would when driving without a trailer to help to avoid heavy braking and sudden turns.

### **Passing**

More passing distance is needed when towing a trailer. The combination of the vehicle and trailer will not accelerate as quickly and is much longer than the vehicle alone. It is necessary to go much farther beyond the passed vehicle before returning to the lane. Pass on level roadways. Avoid passing on hills if possible.

### **Backing Up**

Hold the bottom of the steering wheel with one hand. To move the trailer to the left, move that hand to the left. To move the trailer to the right, move that hand to the right. Always back up slowly and, if possible, have someone guide you.

### **Making Turns**

<b>Caution</b>
Turn more slowly and make wider arcs when towing a trailer to prevent damage to your vehicle. Making very sharp turns could cause the trailer to contact the vehicle.

Make wider turns than normal when towing, so the trailer does not go over soft shoulders, over curbs, or strike road signs, trees, or other objects. Always signal turns well in advance. Do not steer or brake suddenly.

### **Driving on Grades**

It is recommended to turn off one-pedal driving while trailering. For increased coast braking, shift to L (Low) before starting down a long or steep downhill grade. Use regenerative braking to help slow the vehicle or maintain speed by keeping the vehicle in gear and limiting the initial battery charge to 80% or less. Avoid using Regen on Demand. See *Hill and Mountain Roads* ⇨ 174.

## Viewing Systems

If equipped, the viewing systems on the vehicle can improve visibility while hitching, backing up, and driving with a trailer. See *Driver Assistance Systems* ⇨ 227.

## Parking on Hills

### Warning

To prevent serious injury or death, always park your vehicle and trailer on a level surface when possible.

When parking your vehicle and trailer on a hill:

1. Press and hold the brake pedal, but do not shift into P (Park). Turn the wheels toward the curb if facing downhill or toward traffic if facing uphill.
2. Have someone place chocks under the trailer wheels.
3. When the wheel chocks are in place, gradually release the brake pedal to allow the chocks to absorb the load of the trailer.
4. Reapply the brake pedal. Then apply the electric parking brake and shift into P (Park).

5. Release the brake pedal.

## Leaving After Parking on a Hill

1. Apply and hold the brake pedal.
  - Start the vehicle.
  - Shift into the desired gear.
  - Release the parking brake.
2. Let up on the brake pedal.
3. Drive slowly until the trailer is clear of the chocks.
4. Stop and have someone pick up and store the chocks.

## Launching and Retrieving a Boat

### Backing the Trailer into the Water

### Warning

- Have all passengers get out of the vehicle before backing onto the sloped part of the ramp. Lower the driver and passenger side windows before backing onto the ramp. This will provide a means of escape in the unlikely event the vehicle slides into the water.

(Continued)

### Warning (Continued)

- If the boat launch surface is slippery, have the driver remain in the vehicle with the brake pedal applied while the boat is being launched. The boat launch can be especially slippery at low tide when part of the ramp was previously submerged at high tide. Do not back onto the ramp to launch the boat if you are not sure the vehicle can maintain traction.
- Do not move the vehicle if someone is in the path of the trailer. Some parts of the trailer might be underwater and not visible to people who are assisting in launching the boat.

Disconnect the trailer wiring before backing the trailer into the water to prevent damage to the electrical circuits. Reconnect the wiring to the trailer after removing the trailer from the water. If the trailer has electric brakes that can function when the trailer is submerged, it might help to leave the electrical trailer connector attached to maintain trailer brake functionality while on the boat ramp.

To back the trailer into the water:

1. Slowly back down the boat ramp until the boat is floating, but no further than necessary.
2. Press and hold the brake pedal, but do not shift into P (Park).
3. Have someone place chocks under the front wheels of the vehicle.
4. Gradually release the brake pedal to allow the chocks to absorb the load of the trailer.
5. Reapply the brake pedal. Then apply the parking brake and shift into P (Park).
6. Release the brake pedal.

#### **Pulling the Trailer from the Water**

1. Press and hold the brake pedal.
2. Start the vehicle and shift into D (Drive) or L (Low).
3. Release the parking brake.
4. Let up on the brake pedal.
5. Drive slowly until the tires are clear of the chocks.

6. Stop and have someone pick up and store the chocks.
7. Slowly pull the trailer from the water.

#### **Caution**

If the vehicle tires begin to spin and the vehicle begins to slide toward the water, remove your foot from the accelerator pedal and apply the brake pedal. Seek help to have the vehicle towed up the ramp.

#### **Maintenance when Trailer Towing**

The vehicle needs service more often when used to tow trailers. See *Maintenance Schedule* ⇨ 359. It is especially important to check the cooling system and brake system before and during each trip.

Check periodically that all nuts and bolts on the trailer hitch are tight.

## **Trailer Towing**

### **Caution**

Towing a trailer improperly can damage the vehicle and result in costly repairs not covered by the vehicle warranty. To tow a trailer correctly, follow the directions in this section and see your dealer for important information about towing a trailer with the vehicle.

Trailer towing is different than just driving the vehicle by itself. Trailer towing means changes in handling, acceleration, braking, and durability. Successful, safe trailer towing takes correct equipment, and it has to be used properly.

The following information has many time-tested, important trailer towing tips and safety rules. Many of these are important for your safety and that of your passengers. Read this section carefully before pulling a trailer.

## Trailer Weight

### Warning

Never exceed the towing capacity for your vehicle.

Safe trailering requires monitoring the weight, speed, altitude, road grades, outside temperature, and how frequently the vehicle is used to tow a trailer.

## Trailer Weight Ratings

When towing a trailer, the combined weight of the vehicle, vehicle contents, trailer, and trailer contents must be below all of the maximum weight ratings for the vehicle, including:

- Gross Combined Weight Rating (GCWR)
- Gross Vehicle Weight Rating (GVWR)
- Maximum Trailer Weight Rating
- Maximum Trailer Tongue Weight Rating
- Gross Axle Weight Rating-Rear (GAWR-RR)

See “Weight-Distributing Hitch and Adjustment” under *Towing Equipment* ⇨ 270 to determine if equalizer bars are required to obtain the maximum trailer weight rating.

See “Trailer Brakes” under *Towing Equipment* ⇨ 270 to determine if brakes are required based on your trailer's weight.

The only way to be sure the weight is not exceeding any of these ratings is to weigh the tow vehicle and trailer combination, fully loaded for the trip, getting individual weights for each of these items.

A trailering information label on the center pillar (B-pillar) shows tow rating information for the vehicle.

### Warning

You and others could be seriously injured or killed if the trailer is too heavy or the trailer brakes are inadequate for the load. The vehicle may be damaged, and the repairs would not be covered by the vehicle warranty.

Only tow a trailer if all the steps in this section have been followed. Ask your dealer for advice and information about towing a trailer.

## Gross Combined Weight Rating (GCWR)

GCWR is the total allowable weight of the completely loaded vehicle and trailer including any passengers, cargo, equipment, and accessories. Do not exceed the GCWR for your vehicle. The GCWR for the vehicle is on the Trailering Information Label.

To check that the weight of the vehicle and trailer are within the GCWR for the vehicle, follow these steps:

1. Start with the "curb weight" from the Trailering Information Label.
2. Add the weight of the trailer loaded with cargo and ready for the trip.
3. Add the weight of all passengers.
4. Add the weight of all cargo in the vehicle.
5. Add the weight of hitch hardware such as a draw bar, ball, load equalizer bars, or sway bars.
6. Add the weight of any accessories or aftermarket equipment added to the vehicle.

The resulting weight cannot exceed the GCWR value on the Trailering Information Label.



The GCWR can also be confirmed by weighing the vehicle and trailer on a public scale. The vehicle and trailer should be loaded for the trip with passengers and cargo.

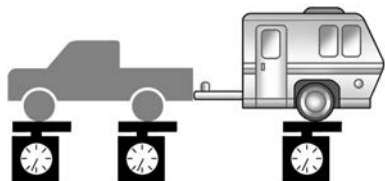

### **Gross Vehicle Weight Rating (GVWR)**

For information about the vehicle's maximum load capacity, see *Vehicle Load Limits* ⇨ 176. When calculating the GVWR with a trailer attached, the trailer tongue weight must be included as part of the weight the vehicle is carrying.

### **Maximum Trailer Weight**

The maximum trailer weight rating is calculated assuming the tow vehicle has a driver, a front seat passenger, and all required trailering equipment. This value represents the heaviest trailer the vehicle can tow, but it may be necessary to reduce the trailer weight to stay within the GCWR, GVWR, maximum trailer tongue load, or GAWR-RR for the vehicle.

Use the Trailering Information Label to determine how much the trailer can weigh.

### **Maximum Trailer Tongue Weight Rating**

The maximum trailer tongue weight rating is the allowable trailer tongue weight that the vehicle can support using a conventional trailer hitch. It may be necessary to reduce the overall trailer weight to stay within the maximum trailer tongue weight rating while still maintaining the correct trailer load balance. A fifth-wheel or gooseneck hitch may support a higher tongue weight.

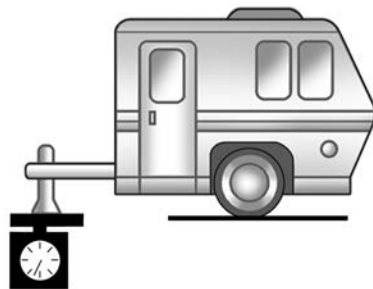

The maximum trailer tongue weight rating is shown on the Trailering Information Label.

The trailer tongue weight contributes to the Gross Vehicle Weight (GVW). GVW includes the curb weight of your vehicle, any passengers, cargo, equipment and the trailer tongue weight. Vehicle options, passengers, cargo, and equipment reduce the maximum allowable tongue weight the vehicle can carry, which also reduces the maximum allowable trailer weight.

## Trailer Load Balance

The correct trailer load balance must be maintained to ensure trailer stability. Incorrect load balance is a leading cause of trailer sway.

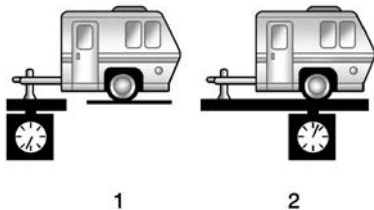

The trailer tongue weight (1) should be 10–15% and fifth-wheel or gooseneck tongue weight should be 15–25% of the total loaded trailer weight (2). Some specific trailer types, such as boat trailers, fall outside of this range. Always refer to the trailer owner's manual for the recommended trailer tongue weight for each trailer. Never exceed the maximum loads for your vehicle, hitch, and trailer.

The trailer load balance percentage is calculated as: weight (1) divided by weight (2) times 100.

After loading the trailer, separately weigh the trailer and then the trailer tongue and calculate the trailer load balance percentage to see if the weights and distribution are appropriate for your vehicle. If the trailer weight is too high, it may be possible to transfer some of the cargo into your vehicle. If the trailer tongue weight is too high or too low, it may be possible to rearrange some of the cargo inside of the trailer.

Do not exceed the maximum allowable tongue weight for your vehicle. Use the shortest hitch extension available to position the hitch ball closer to your vehicle. This will help reduce the effect of the trailer tongue weight on the trailer hitch and the rear axle.

If a cargo carrier is used in the trailer hitch receiver, choose a carrier that positions the load as close to the vehicle as possible. Make sure the total weight, including the carrier, is no more than half of the maximum allowable tongue weight for the vehicle or 227 kg (500 lb), whichever is less.

## Rear Gross Axle Weight Rating (GAWR-RR)

The GAWR-RR is the total weight that can be supported by the rear axle of the vehicle. Do not exceed the GAWR-RR for the vehicle, with the tow vehicle and trailer fully loaded for the trip including the weight of the trailer tongue. If using a weight-distributing hitch, do not exceed the GAWR-RR before applying the weight distribution spring bars.

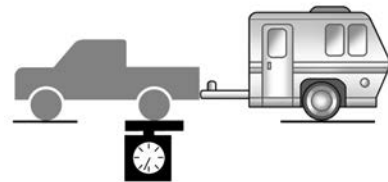

The GAWR-RR for the vehicle is on the Trailing Information Label.

For additional assistance with trailering or additional information, see your dealer.

## Towing Equipment

### Hitches

#### Warning

In order to avoid serious injury or property damage, always follow the hitch manufacturer's instructions when securing your draw bar/coupling device to the vehicle's hitch receiver.

Ensure that the draw bar/coupling device is secured with a locking retainer pin or other means such that rotation of the pin or locking mechanism will not cause the pin to back out or loosen during use. Failure to correctly secure the draw bar/coupling device to the receiver can result in separation of the hitch/receiver while towing.

### Conventional Hitch

A conventional hitch is bolted to the frame or cross member of the tow vehicle, and is generally rated Class 2, 3, or 4.

Always use the correct hitch equipment for your vehicle. Crosswinds, large trucks going by, and rough roads can affect the trailer and the hitch.

Proper hitch equipment for your vehicle helps maintain control of the vehicle-trailer combination. Many trailers can be towed using a weight-carrying hitch with a coupler latched to the hitch ball, or a tow eye latched to a pintle hook. Other trailers may require a weight-distributing hitch that uses spring bars to distribute the trailer tongue weight between your vehicle and trailer axles. See "Maximum Trailer Tongue Weight Rating" under *Trailer Towing* ⇨ 266 for weight limits with various hitch types.

Never attach rental hitches or other bumper-type hitches. Only use frame-mounted hitches that do not attach to the bumper.

Consider using mechanical sway controls with any trailer. Ask a trailering professional about sway controls or refer to the trailer manufacturer's recommendations and instructions.

### Weight-Distributing Hitch and Adjustment

A weight-distributing hitch may be useful with some trailers. Use the following guidelines to determine if a weight-distributing hitch should be used.

Vehicle Series	Trailer Weight	Weight-Distributing Hitch Usage	Hitch Distribution
EV Truck	Up to 2 720 kg (6,000 lb)	Not Required	50%
EV Truck	Over 2 720 kg (6,000 lb)	Required	50%

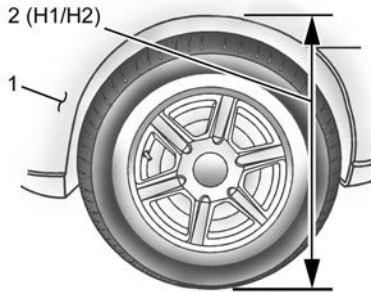

1. Front of Vehicle
2. H1/H2 Body to Ground Distance

### Adjusting the Equalizer Bars

1. Position the truck so that the trailer is ready to connect (Keep trailer detached).
2. Measure the height of the top of the front wheel opening at the fender to the ground (H1).
3. Attach the vehicle to the trailer. Do not attach weight distribution bars at this time.
4. Measure the height of the top of the front wheel opening on the fender to the ground (H2).
5. Install and adjust the tension in the weight distributing bars per the manufacturer's recommendations so that the height of the front fender is approximately  $H2 - [(H2-H1)/2]$  (half way between the two measured ride heights).
6. Visually inspect the trailer and weight distributing hitch to ensure that the manufacturer's recommendations have been met.

Measurement	Height Example 1500 (mm)
H1	1000
H2	1050
H2-H1	50
$(H2-H1)/2$	25
$H2 - [(H2-H1)/2]$	1025

### Adjusting the Equalizer Bars with Air Suspension

- Adjust the vehicle air suspension to "Normal Ground Clearance Height."
- Position the truck so that the trailer is ready to connect (Keep trailer detached).
- Enable air suspension "Service Mode" in the center infotainment screen under Settings>Vehicle>/Suspension.
- Measure the height of the top of the front wheel opening at the fender to the ground (H1).
- Attach the vehicle to the trailer. Do not attach weight distribution bars at this time.
- Measure the height of the top of the front wheel opening on the fender to the ground (H2).
- Install and adjust the tension in the weight distributing bars per the manufacturer's recommendations so that the height of the front fender is approximately  $H1 + [(H2-H1)/3]$  (1/3 between the two measured ride heights, above the primary ride height {H1}).
- Disable air suspension "Service Mode."
- Air suspension will automatically adjust ride height following Step 8.
- Visually inspect the trailer and weight-distributing hitch to ensure that the manufacturer's recommendations have been met.

Measurement	Height Example with Air Suspension (mm)
H1	1 000
H2	1 060
H2-H1	60
$(H2-H1)/3$	20
$H1+[(H2-H1)/3]$	1 020

### Tires

- Do not tow a trailer while using a compact spare tire on the vehicle.
- Tires must be properly inflated to support loads while towing a trailer. See *Tires* ⇨ 314 for instructions on proper tire inflation.

### Safety Chains

Always attach safety chains between the vehicle and the trailer. Instructions about safety chains may be provided by the hitch manufacturer or by the trailer manufacturer.

If the trailer being towed weighs up to 2 271 kg (5,000 lb) with a factory-installed step bumper, safety chains may be attached

to the attaching points on the bumper; otherwise, safety chains should be attached to holes on the trailer hitch.

Cross the safety chains under the tongue of the trailer to help prevent the tongue from contacting the road if it becomes separated from the hitch. Always leave just enough slack so the combination can turn. Never allow safety chains to drag on the ground.

### Trailer Brakes

Loaded trailers over 900 kg (2,000 lb) must be equipped with brake systems and with brakes for each axle. Trailer braking equipment conforming to Canadian Standards Association (CSA) requirement CAN3-D313, or its equivalent, is recommended.

State or local regulations may require trailers to have their own braking system if the loaded weight of the trailer exceeds certain minimums that can vary from state to state. Read and follow the instructions for the trailer brakes so they are installed, adjusted, and maintained properly.

### Warning

Never attempt to tamper with the hydraulic brake system for your trailer brakes. Do not connect a trailer's hydraulic brake system directly to your vehicle's hydraulic brake system. If you do, both the vehicle antilock brakes and the trailer brakes may not function, which could result in a crash.

**Trailer Lamps**

Always check that all trailer lamps are working at the beginning of each trip, and periodically on longer trips.

If equipped, the Trailing App will monitor the right-hand turn/brake lamp circuit, left-hand turn/brake lamp circuit, running lamp circuit, and reverse lamp circuits on the trailer. Driver Information Center (DIC) messages and Trailing App alerts may be displayed if lighting circuit issues are detected on the trailer.

If a trailer cannot be detected, the trailer-related DIC messages and/or Trailing App alerts will not display.

Pressing START LIGHT TEST in the Trailing App automatically activates trailer lamps. The Trailing App is not a substitute for manually inspecting your trailer lamps. See *Trailing App* ⇨ 279.

**Trailer Connection and Lamp Messages**

When a trailer is properly connected and working, no trailer connection or lamp messages appear on the Driver Information Center (DIC). However; if the vehicle detects an issue with a trailer connection or lamp, you may see the following DIC message(s):

- **TRAILER DISCONNECTED CHECK CONNECTION** appears when a connected trailer is disconnected. It appears immediately when the vehicle is on, or upon the next start-up if the trailer was disconnected while the vehicle was off. Check the trailer connection as appropriate.
- **CHECK TRAILER XXX LAMP** appears when there is a detected lamp or wiring fault on the trailer. Check the trailer wiring and lamps.

**Turn Signals When Towing a Trailer**

When properly connected, the trailer turn signals will illuminate to indicate the vehicle is turning, changing lanes, or stopping. When towing a trailer, the arrows on the instrument cluster will illuminate even if the trailer is not properly connected or the bulbs are burned out.

**Tow/Haul Mode**

For instructions on how to enter Tow/Haul mode, see *Driver Mode Control* ⇨ 194.

Tow/Haul mode assists when pulling a heavy trailer or a large or heavy load.

Tow/Haul mode is designed to be most effective when the vehicle and trailer combined weight is at least 75% of the vehicle's Gross Combined Weight Rating (GCWR). See "Maximum Trailer Weight" under *Trailer Towing* ⇨ 266.

Tow/Haul Mode is most useful when towing a heavy trailer or carrying a large or heavy load:

- through rolling terrain
- in stop-and-go traffic
- in busy parking lots

Operating the vehicle in Tow/Haul mode when lightly loaded or not towing will not cause damage; however, it is not recommended and may result in unpleasant engine and transmission driving characteristics and reduced fuel economy.

**Integrated Trailer Brake Control System**

The vehicle may have an Integrated Trailer Brake Control (ITBC) system for use with electric trailer brakes or most electric over hydraulic trailer brake systems. These instructions apply to both types of electric trailer brakes.



This symbol is on the Trailer Brake Control Panel on vehicles with an ITBC system. The power output to the trailer brakes is proportional to the amount of vehicle braking. This available power output to the trailer brakes can be adjusted to a wide range of trailering situations.

The ITBC system is integrated with the vehicle's brake, antilock Brake System (ABS), and StabiliTrak/Electronic Stability Control (ESC) systems. In trailering conditions that cause the vehicle's anti-lock brake or StabiliTrak/ESC systems to activate, power sent to the trailer's brakes will be automatically adjusted to minimize trailer wheel lock-up. This does not imply that the trailer has StabiliTrak/ESC.

If the vehicle's brake, ABS, or StabiliTrak/ESC systems are not functioning properly, the ITBC system may not function fully or at all. Make sure all of these systems are fully operational to allow the ITBC system to function properly.

The ITBC system is powered through the vehicle's electrical system. Turning the vehicle off will also turn off the ITBC system. The ITBC system is fully functional only when the vehicle is ON/RUN.

#### Warning

Connecting a trailer that has an air brake system may result in reduced or complete loss of trailer braking, including increased stopping distance or trailer instability which could result in serious injury, death, or property damage. Only use the ITBC system with electric or electric over hydraulic trailer brake systems.

#### Trailer Brake Control Panel

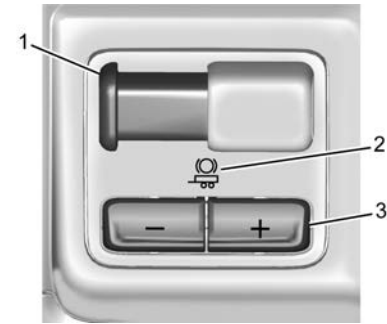

1. Manual trailer brake apply lever
2. Trailer symbol
3. Trailer gain adjustment buttons

The trailer symbol on the control panel will light amber when a trailer with electric brakes is connected.

The ITBC control panel is on the instrument panel to the right of the steering column. The control panel allows adjustment to the amount of output, referred to as Trailer Gain, available to the trailer brakes and allows manual application of the trailer brakes. Use the ITBC control panel and the DIC trailer brake display page to adjust and display power output to the trailer brakes.



### Trailer Brake DIC Display Page

The ITBC display page indicates:

- Trailer Gain setting
- Output to the trailer brakes
- Trailer connection
- System operational status

To display:

- Scroll through the DIC menu pages
- Press a Trailer Gain (+) or (-) button
- Activate the Manual Trailer Brake Apply Lever

#### TRAILER GAIN:

Press a Trailer Gain button to recall the current Trailer Gain setting. Each press and release of the gain buttons will change the Trailer Gain setting. Press the Trailer Gain (+) or (-) to adjust. Press and hold to continuously adjust the Trailer Gain. To turn the output to the trailer off, adjust the Trailer Gain setting to 0.0. This setting can be adjusted from 0.0 to 10.0 with a trailer connected or disconnected.

**TRAILER OUTPUT:** This displays anytime a trailer with electric brakes is connected. Output to the trailer brakes is based on the amount of vehicle braking present and

relative to the Trailer Gain setting. Output is displayed from 0 to 100% for each gain setting.

The Trailer Output will indicate “- - - -” on the Trailer Brake Display Page whenever the following occur:

- No trailer is connected
- A trailer without electric brakes is connected, no DIC message will display
- A trailer with electric brakes has become disconnected, a CHECK TRAILER WIRING message displays on the DIC
- There is a fault present in the wiring to the trailer brakes, a CHECK TRAILER WIRING message displays on the DIC
- The ITBC system is not working due to a fault, a SERVICE TRAILER BRAKE SYSTEM message displays in the DIC

#### Manual Trailer Brake Apply Lever

Slide this lever right to apply the trailer electric brakes independent of the vehicle brakes. Use this lever to adjust Trailer Gain to achieve the proper power output to the trailer brakes. This lever may also be used to request additional trailer braking at any time. The trailer and vehicle brake lamps

will come on when either vehicle brakes or manual trailer brakes are applied and properly connected.

#### Trailer Gain Adjustment Procedure

Trailer Gain should be set for a specific trailering condition and it must be readjusted anytime vehicle loading, trailer loading, or road surface conditions change.

#### Warning

Trailer brakes that are over-gained or under-gained may not stop the vehicle and the trailer as intended and can result in a crash. Always follow the instructions to set the Trailer Gain for the proper trailer stopping performance.

To adjust Trailer Gain for each towing condition:

1. Drive the vehicle with the trailer attached on a level road surface representative of the towing condition and free of traffic at about 32 to 40 km/h (20 to 25 mph) and fully apply the Manual Trailer Brake apply lever. Adjusting Trailer Gain at speeds lower than 32 to 40 km/h (20 to 25 mph) may result in an incorrect gain setting.

2. Adjust the Trailer Gain, using the Trailer Gain adjustment buttons, to just below the point of trailer wheel lockup, indicated by trailer wheel squeal or tire smoke when a trailer wheel locks. Trailer wheel lockup may not occur if towing a heavily loaded trailer. In this case, adjust the Trailer Gain to the highest allowable setting for the towing condition.
3. Readjust Trailer Gain any time vehicle loading, trailer loading, or road surface conditions change or if trailer wheel lockup is noticed at any time while towing.

#### Other ITBC-Related DIC Messages

**TRAILER BRAKES CONNECTED:** This message will briefly display when a trailer with electric brakes is first connected to the vehicle. This message will automatically turn off in about 10 seconds. This message can be acknowledged before it automatically turns off.

**CHECK TRAILER WIRING:** This message will display if:

- The ITBC system first determines connection to a trailer with electric brakes and then the trailer harness becomes disconnected from the vehicle.

If the disconnect occurs while the vehicle is stationary, this message will automatically turn off in about 30 seconds. This message will also turn off if it is acknowledged or if the trailer harness is reconnected.

If the disconnect occurs while the vehicle is moving, this message will continue until the vehicle is turned off. This message will also turn off if it is acknowledged or if the trailer harness is reconnected.

- There is an electrical fault in the wiring to the trailer brakes. This message will continue as long as there is an electrical fault in the trailer wiring. This message will also turn off if it is acknowledged.

To determine whether the electrical fault is on the vehicle side or trailer side of the trailer wiring harness connection:

1. Disconnect the trailer wiring harness from the vehicle.
2. Turn the vehicle off.
3. Wait 10 seconds, then turn the vehicle back to RUN.
4. If the CHECK TRAILER WIRING message reappears, the electrical fault is on the vehicle side.

If the CHECK TRAILER WIRING message only reappears when connecting the trailer wiring harness to the vehicle, the electrical fault is on the trailer side.

**SERVICE TRAILER BRAKES OR REDUCED TRAILER BRAKING:** This message will display if the electric trailer brake performance is either reduced or non-functional.

**HOLD LAST KNOWN GAIN:** This message will display if it is no longer possible to adjust the trailer brake gain. Trailer brakes may or may not still be functional, and it is not possible to adjust brake gain based on road conditions. The trailer brakes may remain functional until the next time the vehicle is turned off.

**TRAILER BRAKES DISABLED SERVICE REQUIRED:** This message will display when there is a problem with the ITBC system. If this message continues over multiple restarts, have the vehicle serviced.

If the CHECK TRAILER WIRING, TRAILER BRAKES DISABLED SERVICE REQUIRED, SERVICE TRAILER BRAKE SYSTEM, or REDUCED TRAILER BRAKING message displays while driving, the ITBC system may not be fully functional or may not function at all. When traffic conditions allow, carefully pull the vehicle over to the side of the road and turn

the vehicle off. Check the wiring connection to the trailer and turn the vehicle back on. If either of these messages continue, either the vehicle or trailer needs service.

### **Warning**

Driving while the trailer braking system is malfunctioning may increase loading on the vehicle's braking system or lead to trailer instability. Use caution. Drive slowly and allow for increased stopping distances.

A GM dealer may be able to diagnose and repair problems with the trailer. However, any diagnosis and repair of the trailer is not covered under the vehicle warranty. Contact your trailer dealer for assistance with trailer repairs and trailer warranty information.

## **Trailer Sway Control (TSC)**

Vehicles with StabiliTrak/Electronic Stability Control (ESC) have a Trailer Sway Control (TSC) feature. Trailer sway is unintended side-to-side motion of a trailer while towing. If the vehicle is towing a trailer and the TSC detects that sway is increasing, the vehicle brakes are selectively applied at each wheel, to help reduce excessive trailer sway.

If equipped with the Integrated Trailer Brake Control (ITBC) system, and the trailer has an electric brake system, StabiliTrak may also apply the trailer brakes.



If TSC is enabled, the Traction Control System (TCS)/StabiliTrak warning light will flash on the instrument cluster. Reduce vehicle speed by gradually removing your foot from the accelerator. If trailer sway continues, StabiliTrak can help slow the vehicle down. TSC will not function if StabiliTrak is turned off. See *Traction Control/Electronic Stability Control* ⇨ 191.

### **Warning**

Trailer sway can result in a crash and in serious injury or death, even if the vehicle is equipped with TSC.

If the trailer begins to sway, reduce vehicle speed by gradually removing your foot from the accelerator. Then pull over to check the trailer and vehicle to help correct possible causes, including an improperly or overloaded trailer, unrestrained cargo, improper trailer hitch configuration, or improperly inflated or incorrect vehicle or trailer tires. See *Towing Equipment* ⇨ 270 for trailer ratings and hitch setup recommendations.

## **Aftermarket Electronic Trailer Sway Control Devices**

Some trailers may come equipped with an electronic device designed to reduce or control trailer sway. Aftermarket equipment manufacturers also offer similar devices that connect to the wiring between the trailer and the vehicle. These devices may interfere with the vehicle's trailer brake systems or other systems, including integrated anti-sway systems, if equipped. Messages

related to trailer connections or trailer brakes could appear on the DIC. The effects of these aftermarket devices on vehicle handling or trailer brake performance is not known.

### Warning

Use of aftermarket electronic trailer sway control devices could result in reduced trailer brake performance, loss of trailer brakes, or other malfunctions, and result in a crash. You or others could be seriously injured or killed. Before using one of these devices:

- Ask the device or trailer manufacturer if the device has been thoroughly tested for compatibility with the make, model, and year of your vehicle and any optional equipment installed on your vehicle.
- Before driving, check the trailer brakes are working properly, if equipped. Drive the vehicle with the trailer attached on a level road surface that is free of traffic at about 32-40 km/h (20-25 mph) and fully apply the

(Continued)

### Warning (Continued)

manual trailer brake apply lever. Also, check the trailer brake lamps and other lamps are functioning correctly.

- If the trailer brakes are not operating properly at any time, or if a DIC message indicates problems with the trailer connections or trailer brakes, carefully pull the vehicle over to the side of the road when traffic conditions allow.

### Trailer Tires

Special Trailer (ST) tires differ from vehicle tires. Trailer tires are designed with stiff sidewalls to help prevent sway and to support heavy loads. These features can make it difficult to determine if the trailer tire pressures are low only based on a visual inspection.

Always check all trailer tire pressures before each trip when the tires are cool. Low trailer tire pressure is a leading cause of trailer tire blow-outs.

If the vehicle is equipped with a trailer tire pressure monitoring system, see the trailer tire pressure monitoring system description and the trailering app.

Trailer tires deteriorate over time. The trailer tire sidewall will show the week and year the tire was manufactured. Many trailer tire manufacturers recommend replacing tires more than six years old.

Overloading is another leading cause of trailer tire blow-outs. Never load your trailer with more weight than the tires are designed to support. The load rating is located on the trailer tire sidewall.

Always know the maximum speed rating for the trailer tires before driving. This may be significantly lower than the vehicle tire speed rating. The speed rating may be on the trailer tire sidewall. If the speed rating is not shown, the default trailer tire speed rating is 105 km/h (65 mph).

### Trailering App

#### Trailer Lights App

If equipped, the Trailer Lights App is on the Home Page of the infotainment display.

Touch Start to cycle the trailer lamps on and off to determine if they are working. The test follows this sequence:

1. The running lights turn on first and remain on throughout the sequence.
2. The brake lights turn on for about two seconds.
3. The left turn signal light flashes three times.
4. The right turn signal light flashes three times.
5. The reverse lights turn on for about two seconds.
6. Steps 2–5 repeat for approximately one minute and 45 seconds, or until the test deactivates.

Touch Stop to stop the test. The test will automatically end after one minute and 45 seconds.

The sequence also deactivates when any of the following occur:

- The vehicle is turned off.
- The vehicle is shifted out of P (Park).
- The brake pedal is pressed.
- The turn signal is activated.
- The hazard warning lights are activated.

### Trailer App

If equipped, the Trailing App is on the Home Page of the infotainment display.

If equipped, this feature allows profiles for connected trailers to be created to view status, to store and track trailer usage information, and to set up towing assist features.

The Trailing App welcome page will appear when the Trailing App is opened for the first time from the Home Page.

When a trailer is electrically connected and a trailer profile has not been created, there will be an option to create a profile, use a guest profile, or select Accessory/No trailer.

When a trailer is electrically connected after a Trailer Profile has been created, the trailer detection pop-up will appear with a list of all of the custom Trailer Profiles made on the vehicle. To load an existing Trailer Profile, select one of the Trailer Profiles listed, or load the Guest Trailer Profile by selecting GUEST TRAILER. Touching Accessory/No trailer will select Accessory/No trailer as the active Trailer Profile and will dismiss the pop-up.

### Create a Trailer Profile

1. Touch Add Trailer on the trailer detection pop-up or touch + Add Trailer in the Trailing App.
2. Follow the on-screen instructions to set up a profile.
3. After a profile is created, set up for additional trailer features may become available, such as Tow/Haul Mode reminder, Trailer Tire Pressure Monitoring System, maintenance reminders, or towing assist.

### Import a Trailer Profile

1. Touch Import on the trailer detection pop-up or touch Import in the Trailing App.
2. Follow the on-screen instructions to import a profile.
3. After a profile is imported, it can be selected from the trailer list. The Tow/Haul Mode reminder, Brake Gain Setting and Trailer Tire Pressure sensor learning, if equipped, do not import.

## Trailer Feature Setup

### Tow/Haul Mode Reminder

To turn the Tow/Haul Mode Reminder setting on, touch Yes. To turn it off, touch No.

### Trailer Tire Pressure Setup

If the Trailer Tire Pressure Monitoring System (TTPMS) is detected, touch the Tire Pressure Monitoring icon to set up tire pressure monitoring.

The trailer tire pressure sensors can transmit up to 7 m (23 feet) from the hitch receiver of the vehicle.

A trailer must be electrically connected to the vehicle before starting the sensor-to-vehicle learn process.

After selecting Start from the Learn Sensors screen, use the Tool Method or the Manual Method (described below) to learn each tire sensor, during which the current tire number will be highlighted. Each sensor has a maximum of two minutes to learn. After a sensor is learned, a checkmark appears next to the tire, the vehicle horn will sound, the vehicle's brake lamps will flash, and all working trailer lamps will flash. It then moves to the next sensor.

The recommended tire pressure must be entered for the trailer tires. This allows the vehicle to alert when the tire pressure is high or low.

**Tool Method:** A TTPMS activation tool can be purchased separately to learn the sensor locations.

**Manual Method:** Without the tool, the air pressure can be increased or decreased in each tire for 10 seconds. Do not exceed the maximum inflation pressure found on the tire sidewalls. Make sure to readjust tire pressure to the recommended level when the process is complete.

### Sensor Learning Steps

To complete the sensor-to-vehicle learn process:

1. Touch Start on the Learn Sensors screen. The horn chirps twice and the Learning Active screen appears on the infotainment display.
2. Start with the driver side front trailer tire.
3. Activate the tool near the valve stem or adjust the air pressure of this tire until the horn chirps and all working vehicle and trailer lights flash.

The process stops without saving the sensor locations if this step takes more than two minutes.

4. Move to the next tire and repeat Step 3 for each sensor. The horn chirps twice when all sensors are completed.
5. Return to the vehicle to complete the setup.

### Maintenance Reminders

To set up maintenance reminders, touch the Trailer Maintenance icon. Follow the on-screen prompts. The maximum number of reminders is 50.

### Towing Assist

To set up towing assist features, if equipped, touch the Towing Assist icon.

1. Select the number of axles on the trailer.
2. Enter trailer dimensions as prompted.

Follow the on-screen instructions to complete setup for available features.

Certain trailer features require a compatible trailer profile be configured and selected. A compatible trailer is a box type trailer (cargo, camper, etc.) with a conventional hitch.

### Transparent Trailer Setup, If Equipped

A rear trailer camera must be mounted on the trailer and electrically connected to the vehicle before transparent trailer feature can be used. See *Assistance Systems for Parking or Backing* ⇨ 228.

Trailer dimensions must be in range and transparent trailer must be calibrated before use.

- Trailer Length: 300 cm (118.1 in) – 970 cm (381.8 in). Measure from center of coupler to furthest rear point on the trailer.
- Trailer Width: 120 cm (47.2 in) – 260 cm (102.3 in). Measure from left edge of trailer to right edge.
- Trailer Height: 1 cm (0.39 in) – 450 cm (177.1 in). Measure from ground to tallest point of the trailer.
- Hitching Point Length: 180 cm (70.8 in) – 970 cm (381.8 in). Measure from center of coupler to middle of tires.
- Trailer Tongue Length: 50 cm (119.6 in) – 220 cm (86.6 in). Measure from center of coupler to trailer front wall.
- Vehicle Hitch Height: 10 cm (3.9 in) – 100 cm (39.3 in). Measure from ground to top of coupler.

- Vehicle Hitch Height: 10 cm (3.9 in) – 100 cm (39.3 in). Measure from hitch receiver to center of ball.

If trailer dimensions are out of range, this feature will be unavailable. Ensure the rear trailer camera is connected.

Follow on screen instructions to drive forward to complete calibration.

### Trailer Length Indicator Setup

Follow on screen instructions to drive forward to complete calibration.

### Trailer Side Blind Zone Alert Setup

Trailer dimensions must be in range to enable this feature.

- Trailer Length: 300 cm (118.1 in) – 1200 cm (472.4 in). Measure from center of coupler to furthest rear point on the trailer.

If trailer dimensions are out of range, this feature will be unavailable.

### Status View

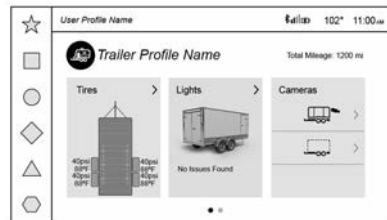

If a trailer is connected, the Status view shows status information for the active trailer profile.

If no trailer is connected, the Status view shows the last trailer profile with a status of Not Connected.

The Status view shows:

- Tires
- Lights
- Cameras
- Maintenance
- Checklist
- Towing Assist

Scroll right or left to see more options.

Each section shows high level status information for the feature. Selecting a section will open up a new screen with additional information and/or options. Selecting a camera view will open up a new screen to preview the camera image.

## Lights

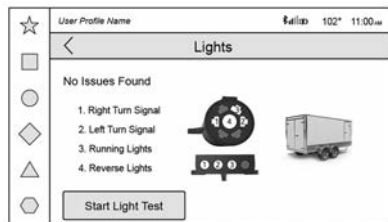

This view will display the names of the trailer connector pins, a graphic of the trailer connector, and a graphic of the back of the trailer.

Any connector pin that failed will be amber color, and the location of the corresponding connection will be highlighted on the graphic of the back of the trailer.

If a trailer connection is detected without any faults, the view will display No Issues Found.

When a trailer is connected, the Trailing App System detects the trailer connection using the Stop/Turn Signal lighting circuits and alerts the driver by requesting a trailer profile setup through the Trailing App System on the infotainment screen. If a default trailer profile is selected, the Trailing App System will not display a Trailer Detection Alert to the user when a trailer is connected.

When a trailer is connected and the vehicle is off, the Trailing App System will periodically pulse the lighting circuits of the trailer to verify it is still connected. The trailer lights may periodically flash as a result of this trailer connection detection. These flashes may be more visible in dark ambient light environments. The flashing or flickering lights are a normal condition and the Trailing App System has built-in protections to prevent the battery from draining. When Theft Alert is enabled, the frequency and pattern of this flashing will change.

If a connected trailer disconnects, a message immediately appears on the DIC if vehicle is on, or the next time the vehicle is turned on. Check your trailer connection if needed.

## Connection Problem

If any of the trailer connections are lost, a message about the connection issue will appear on the Driver Information Center (DIC). The infotainment display will also show the connection issue in the Lights Status view.

## Connection Trailer Lighting Faults Detected

The Trailing App System monitors for electrical faults on the trailer lights. A message about the lighting issue will appear on the DIC. The infotainment display will also show the lighting issue in the Lights Status view. Repair your trailer lights if needed. A trailer lighting issue is not covered by your GM warranty.

The Running Lights connection may not detect partial outages. Activate the light test to check all trailer lamps. See "Light Test" following.

## Light Test

Touch Start Light Test to cycle the trailer lights on and off to determine if they are working. The test follows this sequence:

1. The running lights turn on first and remain on throughout the sequence.



- The brake lights turn on for about two seconds.
- The left turn signal light flashes three times.
- The right turn signal light flashes three times.
- The reverse lights turn on for about two seconds.
- Steps 2-5 repeat for approximately one minute and 45 seconds, or until the test deactivates.

Touch Stop to stop the test. The test will automatically end after one minute and 45 seconds.

The sequence also deactivates when any of the following occur:

- The vehicle is turned off.
- The vehicle is shifted out of P (Park).
- The brake pedal is pressed.
- The turn signal is activated.
- The hazard warning lights are activated.

### Tires

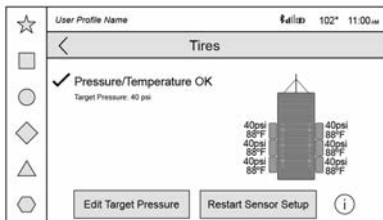

### Tire Pressure and Temperature

If the TTPMS sensor-to-vehicle learn process was completed, the status view will display the current tire pressure and temperature of the trailer tires related to the active Trailer Profile. If a tire's pressure is low or high, the color of the pressure value will be amber. If a sensor malfunctions, the values are dashed lines. If the screen displays "Service Tire Pressure Monitoring System," the vehicle needs to be taken to a dealer for service.

Touch to set up the Trailer Tire Pressure Monitoring System (TTPMS) for the Trailer Profile. See "Trailer Tire Pressure Setup" previously in this section for details on the setup. Also, touch Sensor Setup if the trailer tires were rotated or if the tire pressure sensors in the tires were replaced for this

Trailer Profile. The vehicle will need to relearn the tire sensors and their locations. See "Trailer Tire Pressure Setup" previously in this section.

Touch Edit Target Pressure to change the recommended tire pressure for the trailer's tires. This will change the number at which the vehicle displays alerts related to trailer tire pressure.

### Maintenance

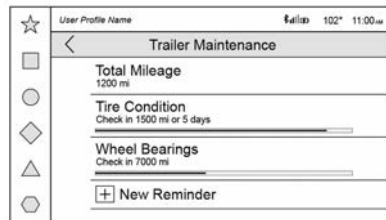

- Touch to view a list of maintenance reminders for the Trailer Profile.

The Maintenance Status view displays reminders for the Trailer Profile. Touch a reminder to view, reset, delete or edit it. Resetting a reminder will reset the time and mileage values for the reminder.

The progress bar turns yellow when the maintenance item reaches 90% complete.

The progress bar turns red when the maintenance item reaches 100% complete.

- Touch New Reminder to add a new maintenance reminder.

Suggested reminders that were previously set will not appear. Suggested reminders that have not been set will have empty boxes next to them. The maximum number of reminders is 50.

### Maintenance Notifications

- Touch Reset to reset time and mileage values for the reminder.
- Touch Remind Me Later to delay the reminder.

If an Upcoming Alert (90%) is dismissed, it will not appear again.

If a Maintenance Due Alert (100%) is dismissed, it will appear when the vehicle is turned off and back on again.

Always follow all of the maintenance instructions that came with your trailer.

### Cameras

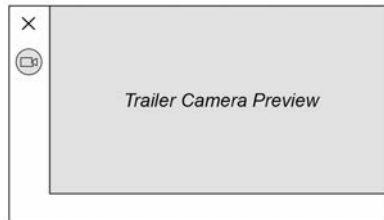

This view shows a preview of the selected camera view. Touch X to exit the preview. Touch the camera icon to open the camera app.

### Checklists

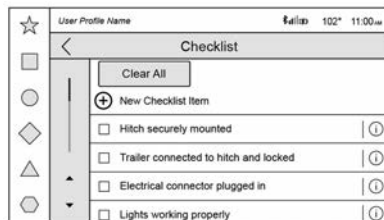

This view shows the recommended steps to take before towing a trailer.

- Touch the box next to each item if that step has been completed.

- Touch **i** to access a detailed view of each step.
- Within each detailed view, touch Next and Previous to navigate between steps.
- Touch Clear All to clear the completed statuses from all items in the current checklist.

### Custom Checklist Items

For each of the Trailer Profile checklists, there is an option to create custom items to view in the checklist. The custom item will appear at the bottom of the checklist.

### Guest Trailer and No Trailer Connected

If a Guest Trailer Profile is active, or if no trailer is connected, the checklist will show all of the checklists associated with Custom Trailer Profiles in addition to default checklist.

### Towing Assist

A trailer should be connected to complete this portion of profile setup.

Touch to set up towing assist features for the Trailer Profile. See "Towing Assist" for details on the setup.

**Guest Trailer Status View**

If the Guest Trailer Profile is active, the Status view shows:

- Lights
- Cameras
- Checklist

Scroll right or left to see more options. The Trailer Status view displays mileage information. Touch to edit, and follow the on-screen prompts. Mileage will reset after the trailer disconnects.

**Accessory/No Trailer Status View**

If the Accessory/No Trailer profile is active, trailer status information is not available.

**Trailers View**

There can be up to five Custom Trailer Profiles on the vehicle.

The Custom Trailer Profiles and Guest Trailer are in order of the most frequently used. The Accessory/No Trailer profile is shown below the Custom Trailer Profiles and Guest Trailer Profile.

All personalization features are based on the settings for each driver in vehicle personalization. The list of Trailer Profiles is based on vehicle personalization settings.

**Guest Trailer**

If the Guest Trailer Profile is the active Trailer Profile, trailer detection, lights/connections status, theft, and the Tow/Haul reminder alerts can be sent. The system will not track total mileage, but the system will track trip mileage if the Guest Trailer Profile is active. The Trailer Tire Pressure Monitoring System or maintenance reminders cannot be set up for a Guest Trailer Profile. The Guest Trailer Profile cannot be edited.

Touch **i** to learn more about the Guest Trailer option.

**Accessory/No Trailer**

If the Accessory/No Trailer Profile is active, alerts will not be sent and the system will not track mileage. The Trailer Tire Pressure Monitoring System or maintenance reminders cannot be set up for the Accessory/No Trailer Profile. The Accessory/No Trailer profile cannot be edited.

**No Trailer Connected**

When there is no trailer connected, Trailer Profiles cannot be activated but most options can be edited.

**Trailer Brake Gain Memory**

The system can store the brake gain setting of a Trailer Profile or a Guest Trailer Profile. When a Trailer Profile or Guest Trailer Profile is selected, and a brake gain setting is set for that Trailer Profile, a quick notice will appear to indicate that the system has recalled that profile's brake gain setting.

If a Trailer Profile is already active and the brake gain setting had been set for that Trailer Profile, the quick notice will trigger whenever the vehicle is turned on.

If there was an error in setting the brake gain for a Trailer Profile, there will be a notification. This pop-up will not appear if the Guest Trailer Profile is active or if there is no trailer connected.

Trailer brake gain should be set for a specific trailering condition and must be adjusted anytime vehicle loading, trailer loading, or road surface conditions change.

## Editing a Trailer Profile

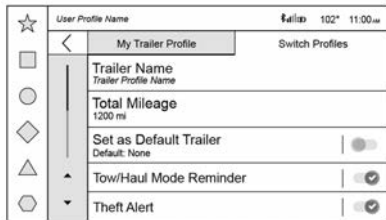

Touch the trailer profile icon/name in the Status View to access the Trailer Profile view:

- Trailer Name
- Total Mileage
- Set as Default Trailer
- Tow/Haul Mode Reminder Alert
- Theft Alert
- Maintenance Alert
- Delete/Remove Trailer

### Trailer Name

Touch to edit the Trailer Profile's name. Use at least one character and no spaces.

## Total Mileage

Touch to edit the Trailer Profile's mileage. Touch Reset to reset trailer mileage to zero, or enter a new value and touch Save.

### Effect on Maintenance Reminders

If the mileage is reset or changed, and mileage has already accumulated, any maintenance reminders that have been set up will be adjusted accordingly.

### Delete/Remove Trailer

Touch to remove the Trailer Profile and all of its settings.

On the pop-up, touch Remove to remove the Trailer Profile from the vehicle. Touch Cancel to dismiss the pop-up and return to the previous view.

Remove will be displayed if there is a connected OnStar plan active with the vehicle. Removing a trailer profile will remove the profile from the vehicle but the profile will still be associated with the user account. However, if there is not a connected OnStar plan, then the remove button will read DELETE and the profile will be deleted permanently.

## Set as Default Trailer

Touch Set as Default Trailer to select the current profile as default.

The default Trailer profile will be automatically selected each time a new connection is detected. The Trailer Detection Alert will no longer appear.

If this setting is turned off, the current trailer profile is not the default trailer.

## Maintenance Alerts

Touch Maintenance Alert to turn on/off Maintenance Alerts for the selected profile. These alerts are based on the Trailer Profile, so the settings for each Trailer Profile must be turned on or off.

The setting will be on by default for each profile. All Maintenance Alerts for that active Trailer Profile will be received.

Turn this setting off to dismiss Maintenance Alerts when that Trailer Profile is active.

### Theft Alert

Theft alert can be set if a trailer is connected and the alert is enabled. When the trailer is disconnected and the vehicle is off, an alarm will sound.

Touch Theft Alert to turn on/off Theft Alerts for the selected profile. These alerts are based on the Trailer Profile, so the settings for each Trailer Profile must be turned on or off.

This setting will be off by default for each Trailer Profile, including the Guest Trailer Profile.

A smartphone will receive a notification that the trailer related to the selected Trailer Profile is disconnected from the vehicle, if the setting is on for the active Trailer Profile, the vehicle has an OnStar or connected service plan and the smartphone number has been added to the account for this notification.

If the setting is turned off for a given Trailer Profile, the smartphone will not receive this security notification even if the Trailer Profile is active.

#### **Tow/Haul Mode Reminder**

This is a reminder to turn on the Tow/Haul Mode when towing a trailer. See *Driver Mode Control* ⇨ 194.

Touch Tow/Haul Mode Reminder to turn on/off Tow/Haul Mode reminders for the selected profile. These alerts are based on the Trailer Profile, so the settings for each Trailer Profile must be turned on or off.

This setting will default to OFF for each Trailer Profile, including the Guest Trailer Profile.

If Tow/Haul Mode is off and this setting is on for a Trailer Profile, each time the vehicle is turned on, a reminder will appear to turn on Tow/Haul Mode when the Trailer Profile is active.

If Tow/Haul Mode is on and this setting is on for a Trailer Profile, the reminder will not appear when the Trailer Profile is active.

## **Conversions and Add-Ons**

### **Add-On Electrical Equipment**

#### **Warning**

The Data Link Connector (DLC) is used for vehicle service and Emission Inspection/Maintenance testing. See *Service Vehicle Soon Light (Propulsion System Failure)*

⇨ 102. A device connected to the DLC —

(Continued)

#### **Warning (Continued)**

such as an aftermarket fleet or driver-behavior tracking device — may interfere with vehicle systems. This could affect vehicle operation and cause a crash. Such devices may also access information stored in the vehicle's systems.

#### **Caution**

Some electrical equipment can damage the vehicle or cause components to not work and would not be covered by the vehicle warranty. Always check with your dealer before adding electrical equipment.

Add-on equipment can drain the vehicle's 12-volt battery, even if the vehicle is not operating.

When adding electrical equipment, it should only be connected using the accessory power outlets. The maximum power that can be supplied by one accessory power outlet or spread across all three is 200 watts or 15 amps. Exceeding 200 watts or 15 amps may cause erratic vehicle operation.

The vehicle has an airbag system. Before attempting to add anything electrical to the vehicle, see *Servicing the Airbag-Equipped Vehicle* ⇨ 61 and *Adding Equipment to the Airbag-Equipped Vehicle* ⇨ 61.

## Vehicle Care

### General Information

General Information .....	291
California Perchlorate Materials Requirements .....	291
Accessories and Modifications .....	291

### Vehicle Checks

Doing Your Own Service Work .....	291
Hood .....	292
Underhood Compartment Overview ...	295
Cooling System .....	296
Washer Fluid .....	297
Brakes .....	297
Brake Fluid .....	298
Battery - North America .....	299
Noise Control System .....	301
Wiper Blade Replacement .....	302
Windshield Replacement .....	302

### Headlamp Aiming

Front Headlamp Aiming .....	303
-----------------------------	-----

### Bulb Replacement

LED Lighting .....	303
--------------------	-----

### Electrical System

High Voltage Devices and Wiring .....	303
Electrical System Overload .....	303
Fuses and Circuit Breakers .....	305

Underhood Compartment Fuse Block .....	305
Instrument Panel Fuse Block (Left) .....	310
Instrument Panel Fuse Block (Right) ...	312

### Wheels and Tires

Tires .....	314
Winter Tires .....	315
All-Terrain Tires .....	315
Tire Sidewall Labeling .....	315
Tire Designations .....	316
Tire Terminology and Definitions .....	317
Tire Pressure .....	319
Tire Pressure Monitor System .....	320
Tire Pressure Monitor Operation .....	321
Tire Inspection .....	326
Tire Rotation .....	326
When It Is Time for New Tires .....	327
Buying New Tires .....	328
Different Size Tires and Wheels .....	329
Uniform Tire Quality Grading .....	330
Wheel Alignment and Tire Balance ....	331
Wheel Replacement .....	331
Tire Chains .....	332
If a Tire Goes Flat .....	332
Tire Sealant and Compressor Kit .....	333
Storing the Tire Sealant and Compressor Kit .....	338
Tire Changing .....	339
Full-Size Spare Tire .....	344

### Jump Starting

Jump Starting - North America .....	344
-------------------------------------	-----

### Towing the Vehicle

Transporting a Disabled Vehicle .....	347
Recreational Vehicle Towing .....	349

### Appearance Care

Exterior Care .....	349
Interior Care .....	354
Floor Mats .....	357

## General Information

For service and parts needs, visit your dealer. You will receive genuine GM parts and GM-trained and supported service people.

Genuine GM parts have one of these marks:



***ACDelco***

## California Perchlorate Materials Requirements

Certain types of automotive applications, such as airbag initiators, seat belt pretensioners, and lithium batteries contained in electronic keys, may contain perchlorate materials. Perchlorate Material –

special handling may apply. See [www.dtsc.ca.gov/hazardouswaste/perchlorate](http://www.dtsc.ca.gov/hazardouswaste/perchlorate).

## Accessories and Modifications

Adding non-dealer accessories or making modifications to the vehicle can affect vehicle performance and safety, including such things as airbags, braking, stability, ride and handling, emissions systems, aerodynamics, durability, Driver Assistance Systems, and electronic systems like antilock brakes, traction control, and stability control. These accessories or modifications could even cause malfunction or damage not covered by the vehicle warranty.

Damage to suspension components caused by modifying vehicle height outside of factory settings will not be covered by the vehicle warranty.

Damage to vehicle components resulting from modifications or the installation or use of non-GM certified parts, including control module or software modifications, is not covered under the terms of the vehicle warranty and may affect remaining warranty coverage for affected parts.

GM Accessories are designed to complement and function with other systems on the vehicle. See your dealer to accessorize the vehicle using genuine GM Accessories installed by a dealer technician.

Also, see *Adding Equipment to the Airbag-Equipped Vehicle* ⇨ 61.

## Vehicle Checks

### Doing Your Own Service Work

#### **Warning**

Never try to do your own service on high voltage battery components. You can be injured and the vehicle can be damaged if you try to do your own service work. Service and repair of these high voltage battery components should only be performed by a trained dealer technician with the proper knowledge and tools.

Exposure to high voltage can cause shock, burns, and even death. The high voltage components in the vehicle can only be serviced by technicians with special training.

(Continued)



**Warning (Continued)**

High voltage components are identified by labels. Do not remove, open, take apart, or modify these components. High voltage cable or wiring has orange covering. Do not probe, tamper with, cut, or modify high voltage cable or wiring.

 **Warning**

Unexpected wheel motion and/or direction when one or more wheels are off the ground for service work may result in injury. The vehicle may:

- Allow the wheels to rotate unexpectedly in either direction regardless of mode selection.
- Allow the wheels to rotate in reaction to attempts to rotate the tire(s) manually.
- Resist attempts to rotate the wheels manually.

Before lifting the vehicle to do your own service work, turn the vehicle off or place the vehicle in the Service Mode. To place  
(Continued)

**Warning (Continued)**

the vehicle in Service Mode, with the vehicle off and the brake pedal not applied, press and hold POWER for more than five seconds.

 **Warning**

It can be dangerous to work on your vehicle if you do not have the proper knowledge, service manual, tools, or parts. Always follow owner's manual procedures and consult the service manual for your vehicle before doing any service work.

If doing some of your own service work, use the proper service manual. It tells you much more about how to service the vehicle than this manual can. To order the proper service manual, see *Publication Ordering Information* ⇨ 373.

This vehicle has an airbag system. Before attempting to do your own service work, see *Servicing the Airbag-Equipped Vehicle* ⇨ 61.

Keep a record with all parts receipts and list the mileage and the date of any service work performed. See *Maintenance Records* ⇨ 363.

**Hood**

Clear any snow from the hood before opening.

 **Warning**

You or others could be injured if caught in the path of the power hood. Make sure there is no one in the way of the hood as it is opening and closing.

**Power Hood Operation**

The vehicle must be in P (Park), doors unlocked, or the remote key in range of the vehicle to operate the power hood.

To open or close the power hood, press  on the instrument panel, the touchpad on the front fascia, or the remote key.

To turn this feature on or off, select Settings > Vehicle > Comfort and Convenience > Power Hood Opening.

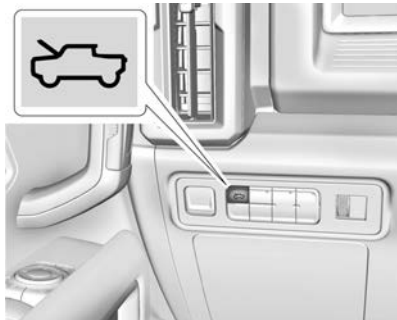

- To open the hood, press  on the instrument panel to the left of the steering wheel once.

To close the hood, press and hold  until the hood closes.

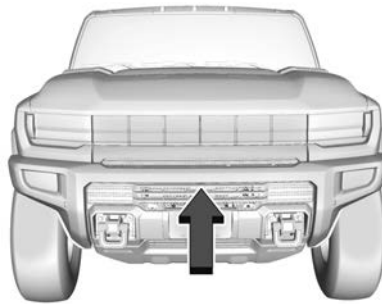

- To open or close the hood, press the touchpad in the center of the front fascia once, when the remote key is within 1 m (3 ft).
- To open the hood with the remote key, press  twice and hold for at least one second.

To close the hood with the remote key, press  twice and hold until the hood closes. See *Remote Key Operation* ⇨ 7.

### Operating the Hood when there is no Electrical Power

The manual release cable should only be used for service and/or emergency use, such as loss of vehicle electrical power. Do not store any cargo in the area near the hood release cable.

#### To open the hood:

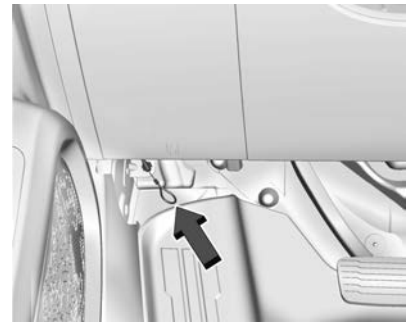

1. Firmly pull the hood release cable twice to release the hood. It is on the lower left side of the instrument panel.
2. Go to the front of the vehicle and lift the hood to the desired height.

**To close the hood:**

1. Before closing the hood, make sure all cargo is properly stowed and does not go above or across the hood seal.
2. Pull the hood down until it is secured in the latch.
3. Check to make sure the hood is latched completely. Push down on the hood to latch if it does not latch completely. Repeat this step with additional force if necessary.

## Underhood Compartment Overview



1. Battery (Under Cover). See *Battery - North America* ⇨ 299.
2. Underhood Compartment Fuse Block (Under Cover). *Underhood Compartment Fuse Block* ⇨ 305.
3. Coolant Surge Tank and Pressure Cap (Under Cover). See *Cooling System* ⇨ 296.
4. Brake Fluid Reservoir (Under Cover). See *Brake Fluid* ⇨ 298.
5. Windshield Washer Fluid Reservoir. See *Washer Fluid* ⇨ 297.

## Cooling System

It is not necessary to regularly check coolant unless a leak is suspected or an unusual noise is heard. A coolant loss could indicate a problem. Have it inspected and repaired by your dealer.

The following explains the cooling system and how to check coolant level.

During vehicle operation and also during charging, the high voltage battery cells in the vehicle are kept within a normal operating temperature range. If the temperature rises above this temperature, the battery cooling system turns on the air conditioning compressor and cools the coolant until the correct temperature is

reached. If the temperature falls below this temperature, a high voltage heater, located outside the battery on a cradle, heats the coolant until the correct temperature is reached.

### Checking Coolant

The coolant needs to be replaced at the appropriate interval. See *Maintenance Schedule* ⇨ 359.

The coolant reservoir is in the underhood compartment. See *Underhood Compartment Overview* ⇨ 295.

To access the coolant reservoir under the hood, the right side access cover needs to be removed.

1. Park on a level surface and turn the vehicle off.
2. Open the hood. See *Hood* ⇨ 292.

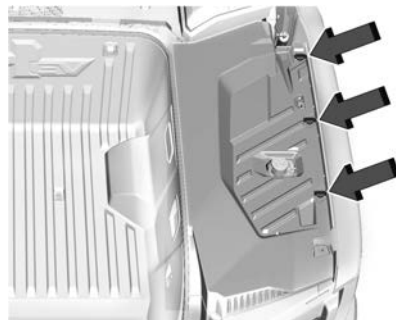

3. Turn the three bolts three quarter turn and remove the right side access cover.



4. After the system has completely cooled, check that the coolant level in the reservoir.

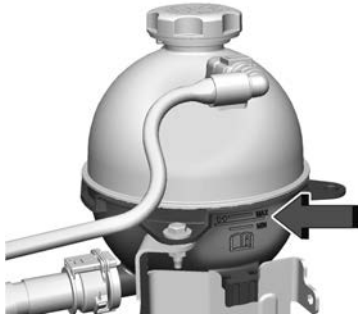

5. If the coolant level is not visible or needs to be adjusted within the reservoir, contact your dealer.

## Washer Fluid

### What to Use

When windshield washer fluid is needed, be sure to read the manufacturer's instructions before use. If operating the vehicle in an area where the temperature may fall below freezing, use a fluid that has sufficient protection against freezing.

## Adding Washer Fluid



Open the cap with the washer symbol on it. Add washer fluid until the tank is full. See *Underhood Compartment Overview* ⇨ 295 for reservoir location.

### Caution

- Do not use washer fluid that contains any type of water repellent coating. This can cause the wiper blades to chatter or skip.
- Do not use engine coolant (antifreeze) in the windshield washer. It can damage the windshield washer system and paint.
- Do not mix water with ready-to-use washer fluid. Water can cause the solution to freeze and damage the washer fluid tank and other parts of the washer system.

(Continued)

### Caution (Continued)

- When using concentrated washer fluid, follow the manufacturer instructions for adding water.
- Fill the washer fluid tank only three-quarters full when it is very cold. This allows for fluid expansion if freezing occurs, which could damage the tank if it is completely full.

## Brakes

Disc brake linings have built-in wear indicators that make a high-pitched warning sound when the brake linings are worn and new linings are needed. The sound can come and go or can be heard all the time when the vehicle is moving, except when applying the brake pedal firmly.

### Warning

The brake wear warning sound means that soon the brakes will not work well. That could lead to a crash. When the brake wear warning sound is heard, have the vehicle serviced.

**Caution**

Continuing to drive with worn-out brake linings could result in costly brake repairs.

Some driving conditions or climates can cause a brake squeal when the brakes are first applied, clearing up following several applications. This does not mean something is wrong with the brakes.

Properly torqued wheel nuts are necessary to help prevent brake pulsation. When tires are rotated, inspect brake linings for wear and evenly tighten wheel nuts in the proper sequence to torque specifications. See *Capacities and Specifications* ⇨ 365.

Brake pads should be replaced as complete axle sets.

**Brake Pedal Travel**

See your dealer if the brake pedal does not return to normal height, or if there is a rapid increase in pedal travel. This could be a sign that brake service may be required.

**Replacing Brake System Parts**

Always replace brake system parts with new, approved replacement parts. If this is not done, the brakes may not work properly. The braking performance can change in many ways if the wrong brake parts are installed or if parts are improperly installed.

**Brake Fluid**

The brake master cylinder reservoir is filled with GM approved DOT 4 brake fluid as indicated on the reservoir cap. See *Underhood Compartment Overview* ⇨ 295 for the location of the reservoir.

**Checking Brake Fluid**

With the vehicle in P (Park) on a level surface, the brake fluid level should be between the minimum and maximum marks on the brake fluid reservoir.

There are only two reasons why the brake fluid level in the reservoir may go down:

- Normal brake lining wear. When new linings are installed, the fluid level goes back up.
- A fluid leak in the brake hydraulic system. Have the brake hydraulic system fixed. With a leak, the brakes will not work well.

Always clean the brake fluid reservoir cap and the area around the cap before removing it.

Do not top off the brake fluid. Adding fluid does not correct a leak. If fluid is added when the linings are worn, there will be too much fluid when new brake linings are installed. Add or remove fluid, as necessary, only when work is done on the brake hydraulic system.

When the brake fluid falls to a low level, the brake warning light comes on. See *Brake System Warning Light* ⇨ 102.

Brake fluid absorbs water over time which degrades the effectiveness of the brake fluid. Replace brake fluid at the specified intervals to prevent increased stopping distance. See *Maintenance Schedule* ⇨ 359.

**What to Add**

Use only GM approved DOT 4 brake fluid from a clean, sealed container. See *Recommended Fluids and Lubricants* ⇨ 361.

 **Warning**

The wrong or contaminated brake fluid could result in damage to the brake system. This could result in the loss of braking leading to a possible injury. Always use the proper GM approved brake fluid.

**Caution**

If brake fluid is spilled on the vehicle's painted surfaces, the paint finish can be damaged. Immediately wash off any painted surface.

**Battery - North America**

This vehicle has a high voltage battery and a standard 12-volt battery.

See your dealer if either the 12-volt or high voltage battery needs service.

**12-Volt Battery**

The original equipment battery is maintenance free. Do not remove the cap and do not add fluid.

Do not disconnect the 12-volt battery during storage.

Refer to the replacement number shown on the original battery label when a new 12-volt battery is needed. The vehicle has an Absorbent Glass Mat (AGM) 12-volt battery. Installation of a standard 12-volt battery will result in reduced 12-volt battery life.

Some 12-volt chargers have an AGM battery setting. This setting limits the charge voltage to 14.8 volts and helps extend the battery life. If available, use the AGM setting when charging the battery.

 **Warning**

**WARNING:** Battery posts, terminals and related accessories can expose you to chemicals including lead and lead compounds, which are known to the State of California to cause cancer and birth defects or other reproductive harm.  
(Continued)

**Warning (Continued)**

Wash hands after handling. For more information go to [www.P65Warnings.ca.gov](http://www.P65Warnings.ca.gov).

See *California Proposition 65 Warning* ⇨ 1.

**High Voltage Battery**

Only a trained service technician should inspect, test, or replace the high voltage battery. The dealer has information on how to recycle the high voltage battery. There is also information available at <https://www.recyclemybattery.com>.

 **Warning**

Damage to the high voltage battery or high voltage system can create a risk of electric shock, overheating, or fire.

If the vehicle is damaged from a moderate to severe crash, flood, fire, or other event, the vehicle should be inspected as soon as possible. Until the vehicle has been inspected, store it outside at least 15 m (50 ft) from any  
(Continued)



**Warning (Continued)**

structure or anything that can burn. Ventilate the vehicle by opening a window or a door.

Contact Customer Assistance as soon as possible to determine whether an inspection is needed. See *Customer Assistance Offices* ⇨ 368.

If the vehicle is in a crash, the sensing system may shut down the high voltage system. When this occurs, the high voltage battery is disconnected and the vehicle will not start. The SERVICE VEHICLE SOON message in the Driver Information Center (DIC) will display. Before the vehicle can operate again, it must be serviced at your dealer. If a crash occurs or an airbag(s) inflates, see “If a Crash Occurs” under *Collision Damage Repair* ⇨ 372 and *What Will You See after an Airbag Inflates?* ⇨ 56 for additional information.

Keep the vehicle plugged in, even when fully charged, to keep the high voltage battery temperature ready for the next drive. This is important when outside temperatures are extremely hot or cold.

Propulsion power may be reduced in extremely cold temperatures, or if the high voltage battery is too cold. The message BATTERY TOO COLD, PLUG IN TO WARM will display. If the message displays, a level 2 charger is required to heat the battery to a minimum temperature to enable propulsion or charging.

A vehicle cover, which can reduce sun loading on the vehicle and improve high voltage battery life, is available from your dealer.

See *Radio Frequency Statement* ⇨ 374.

**Federal Communications Commission (FCC) Radiation Exposure Statement**

This equipment has been evaluated to be installed and operated at a minimum distance of 5.7 cm (2.2 in) between the device and your body. The vehicle design ensures this distance is maintained during normal use. Changes or modifications to any of these systems by other than an authorized service facility could void authorization to use this equipment.

**Innovation, Science, and Economic Development (ISED) Radiation Exposure Statement**

This equipment complies with RSS-102 radiation exposure limits set forth for an uncontrolled environment. This equipment should be installed and operated with a minimum distance of 5.7 cm (2.2 in) between the radiator and any part of your body. The vehicle design ensures this distance is maintained during normal use. Changes or modifications to any of these systems by other than an authorized service facility could void authorization to use this equipment.

**Vehicle Storage**

The best way to store the vehicle for any length of time is to plug in the charge cord and leave it plugged in. The vehicle monitors and maintains the 12-volt battery daily. It is okay to leave the vehicle plugged in for extended periods of time. Once charged to full, very little energy is required to maintain the 12-volt battery and high voltage battery.

If it is not possible to charge the vehicle with the charge cord left plugged in, be sure to fully charge the high voltage battery

before storing. The vehicle will stop maintenance of the 12-volt battery if the high voltage battery state of charge gets too low.

When storing the vehicle on a long-term basis:

- Keep the high voltage battery state of charge at 30%.
- Attach an AGM/VRLA compatible battery tender or trickle charger to the 12-volt battery.
- Keep the remote key more than 3 m (10 ft) away from the vehicle.

### 12-volt Battery

#### Warning

Batteries have acid that can burn you and gas that can explode. You can be badly hurt if you are not careful. Always wear eye protection. See *Jump Starting - North America* ⇨ 344 for tips on working around a battery without getting hurt.

Do not disconnect the 12-volt battery during storage.

A trickle charger may be attached to the 12-volt battery terminals or trickle charge from the underhood remote positive (+) and negative (-) terminals. See *Jump Starting - North America* ⇨ 344 for location of these terminals.

#### Caution

The vehicle is equipped with an AGM/VRLA 12-volt battery, which can be damaged by using the incorrect type of trickle charger. An AGM/VRLA-compatible charger must be used, with the appropriate setting selected. Follow the trickle charger manufacturer instructions.

With a trickle charger connected to the 12-volt battery, the vehicle will still monitor the 12-volt battery daily, but it will not use energy from the high voltage battery for maintenance.

### High Voltage Battery

After extended storage, it is possible that the vehicle may not operate. If this happens, the high voltage battery may need to be plugged in and charged.

## Noise Control System

### NOISE EMISSIONS WARRANTY

General Motors LLC, warrants to the first person who purchases this vehicle for purposes other than resale and to each subsequent purchaser that this vehicle as manufactured by General Motors LLC, was designed, built and equipped to conform at the time it left General Motors LLC's control with all applicable U.S. EPA Noise Control Regulations. This warranty covers this vehicle as designed, built and equipped by General Motors LLC, and is not limited to any particular part, component or system of the vehicle manufactured by General Motors LLC. Defects in design, assembly or in any part, component or system of the vehicle as manufactured by General Motors LLC, which, at the time it left General Motors LLC's control, caused noise emissions to exceed Federal standards, are covered by this warranty for the life of the vehicle.

## TAMPERING WITH NOISE CONTROL SYSTEM PROHIBITED

Federal law prohibits the following acts or the causing thereof:

1. The removal or rendering inoperative by any person, other than for purposes of maintenance, repair, or replacement, of any device or element of design incorporated into any new vehicle for the purpose of noise control prior to its sale or delivery to the ultimate purchaser or while it is in use; or
2. the use of the vehicle after such device or element of design has been removed or rendered inoperative by any person.

Among those acts presumed to constitute tampering are the acts listed below.

### Insulation:

Removal of the noise shields or any undercab insulation.

### Fan and Drive:

Removal of fan clutch or rendering clutch inoperative.

Removal of fan shroud.

### External Sound System:

Modification of the vehicle's external sound system.

## Wiper Blade Replacement

Windshield wiper blades should be replaced periodically. See the *Maintenance Schedule* ⇨ 359.

Replacement blades come in different types and are removed in different ways. For proper type and length, see *Maintenance Replacement Parts* ⇨ 362.

Caution
<p>Allowing the wiper arm to touch the windshield when no wiper blade is installed could damage the windshield. Any damage that occurs would not be covered by the vehicle warranty. Do not allow the wiper arm to touch the windshield.</p>

To replace the windshield wiper blade:

1. Pull the windshield wiper assembly away from the windshield.

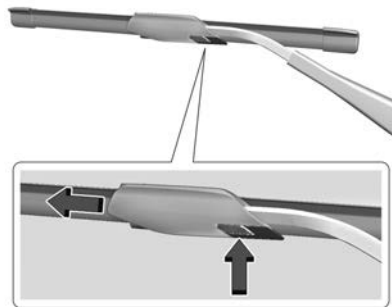

2. Press the button in the middle of the wiper arm connector, and pull the wiper blade away from the arm connector.
3. Remove the wiper blade.
4. Reverse Steps 1–3 for wiper blade replacement.

## Windshield Replacement

### Driver Assistance Systems

If the windshield needs to be replaced and the vehicle is equipped with a front camera sensor for the Driver Assistance Systems, a GM replacement windshield is recommended. The replacement windshield must be installed according to GM specifications for proper alignment. If it is

not, these systems may not work properly, they may display messages, or they may not work at all. See your dealer for proper windshield replacement.

## Headlamp Aiming

### Front Headlamp Aiming

Headlamp aim has been preset and should need no further adjustment.

If the vehicle is damaged in a crash, the headlamp aim may be affected. If adjustment to the headlamps is necessary, see your dealer.

## Bulb Replacement

### LED Lighting

This vehicle has several LED lamps.

For replacement of any LED lighting assembly, contact your dealer.

## Electrical System

### High Voltage Devices and Wiring

#### Warning

Exposure to high voltage can cause shock, burns, and even death. The high voltage components in the vehicle can only be serviced by technicians with special training.

High voltage components are identified by labels. Do not remove, open, take apart, or modify these components. High voltage cable or wiring has orange covering or labels. Do not probe, tamper with, cut, or modify high voltage cable or wiring.

### Electrical System Overload

The vehicle has fuses and circuit breakers to protect against an electrical system overload.

When the current electrical load is too heavy, the circuit breaker opens and closes, protecting the circuit until the current load returns to normal or the problem is fixed.

This greatly reduces the chance of circuit overload and fire caused by electrical problems.

Fuses and circuit breakers protect the wires that provide the power to the devices in your vehicle.

If there is a problem on the road and a fuse needs to be replaced, the same amperage fuse can be borrowed. Choose some feature of the vehicle that is not needed to use and replace it as soon as possible.

To check a fuse, look at the band inside the fuse. If the band is broken or melted, replace the fuse. Be sure to replace a bad fuse with a fuse of the identical size and rating.

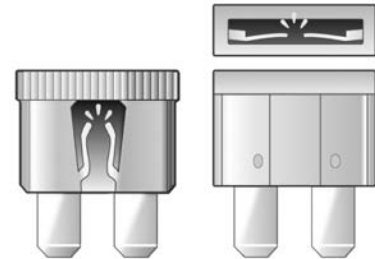



### Replacing a Blown Fuse

1. Turn off the vehicle.
2. Locate the fuse puller in the underhood compartment fuse block.

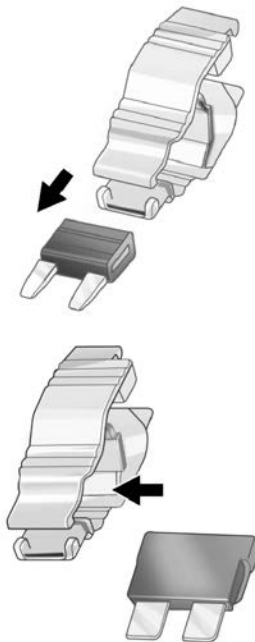

3. Use the fuse puller to remove the fuse from the top or side, as shown above.

4. If the fuse must be replaced immediately, borrow a replacement fuse with the same amperage from the fuse block. Choose a vehicle feature that is not needed to safely operate the vehicle. Repeat Steps 2-3.
5. Insert the replacement fuse into the empty slot of the blown fuse.

At the next opportunity, see your dealer to replace the blown fuse.

### Headlamp Wiring

An electrical overload may cause the lamps to go on and off, or in some cases to remain off. Have the headlamp wiring checked right away if the lamps go on and off or remain off.

### Windshield Wipers

If the wiper motor overheats due to heavy snow or ice, the windshield wipers will stop until the motor cools and will then restart.

Although the circuit is protected from electrical overload, overload due to heavy snow or ice may cause wiper linkage damage. Always clear ice and heavy snow from the windshield before using the windshield wipers.

If the overload is caused by an electrical problem and not snow or ice, be sure to get it fixed.

## Fuses and Circuit Breakers

The wiring circuits in the vehicle are protected from short circuits by a combination of fuses and circuit breakers. This greatly reduces the chance of damage caused by electrical problems.

### **Danger**

Fuses and circuit breakers are marked with their ampere rating. Do not exceed the specified amperage rating when replacing fuses and circuit breakers. Use of an oversized fuse or circuit breaker can result in a vehicle fire. You and others could be seriously injured or killed.



### **Warning**

Installation or use of fuses that do not meet GM's original fuse specifications is dangerous. The fuses could fail, and result in a fire. You or others could be injured or killed, and the vehicle could be damaged.

See *Accessories and Modifications* ⇨ 291 and *General Information* ⇨ 291.

To check or replace a blown fuse, see *Electrical System Overload* ⇨ 303.

## Underhood Compartment Fuse Block

### To Access:

1. Open the hood. See *Hood* ⇨ 292.

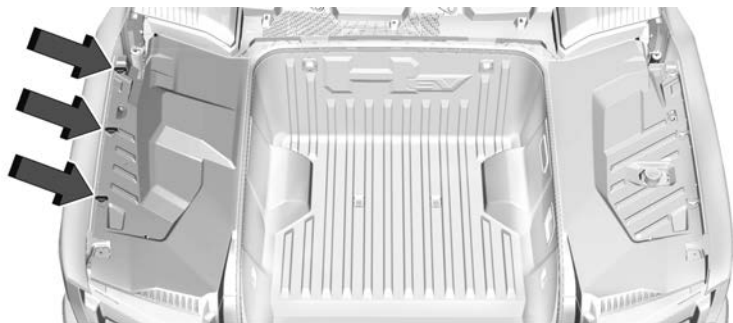

2. The Underhood Compartment Fuse Block is under a cover and side extensions/shields in the underhood compartment. Complete a three-quarter turn on each of the three bolts on the left-side access cover.

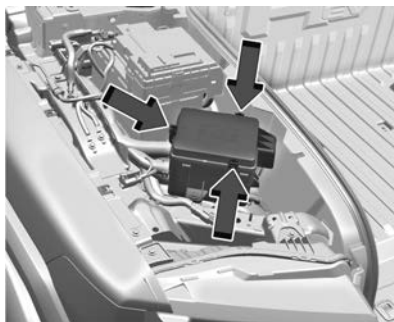

3. Press the clips at the side and back and pull the cover up to access the fuse block.

**Caution**

Spilling liquid on any electrical component on the vehicle may damage it. Always keep the covers on any electrical component.

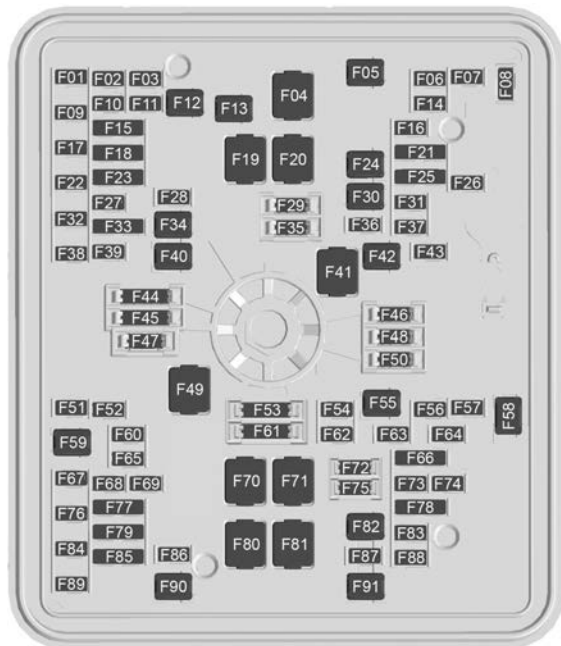

A fuse puller is in the underhood compartment fuse block.

The vehicle may not be equipped with all of the fuses and features shown.

Fuses	Usage
F02	PCV_SCV – Primary Coolant Valve/Secondary Coolant Valve
F03	SPARE
F04	SPARE
F05	SPARE
F06	ACEC/COOL/VLV – Air Conditioning Electric Compressor/Coolant Valve
F07	ESSCP – Energy Storage System Coolant Pump
F08	SPARE
F09	PECP – Power Electronics Coolant Pump
F10	SPARE
F11	SPARE
F12	Rear Glass Open
F13	TRLR CONNECTOR – Trailer Brake Connector
F14	SPARE

Fuses	Usage
F01	ICCM – Integrated Chassis Control Module



Fuses	Usage	Fuses	Usage	Fuses	Usage
F15	CPDL – Charge Port Door Lamp	F26	SPARE	F40	VLM – Vehicle Leveling Module
F16	ALC 1 – Automatic Level Control Main	F27	Park Lamp	F41	SPARE
F17	SPARE	F28	SPARE	F42	Rear Glass Close
F18	ELM 1 – Exterior Lighting Module 1	F29	SPARE	F43	SPARE
F19	T/LAMP LT – Tail Lamp Left	F30	TRANS OIL PMP 1 – Trans Oil Pump 1	F44	SPARE
F20	SADS – Suspension Control Module	F31	SPARE	F45	SPARE
F21	IEC LT 2 – Instrument Panel Fuse Block Left 2	F32	TRANS OIL PMP 2 – Trans Oil Pump 2	F46	SPARE
F22	SPARE	F33	REV/LAMP – Reverse Lamp	F47	SPARE
F23	SPARE	F34	TIM 1 – Trailer Interface Module Primary	F48	SPARE
F24	CHFV – Condensing Heating Flow Valve Motor	F35	SPARE	F49	TBPM – Trailer Brake Power Module
F25	T/LAMP RT – Tail Lamp Right	F36	TPIM 1 – Traction Power Inverter Module 1	F50	SPARE
	VICM – Vehicle Integrated Control Module	F37	SPARE	F51	2ND ROW RT – Second Row Fold Right
	SPARE	F38	TRLR ST/TRN LT – Trail Stop/Turn Lamp Left	F52	SPARE
	SPARE	F39	TRLR ST/TRN RT – Trail Stop/Turn Lamp Right	F53	SPARE
				F54	PFCM – Power Front Closure Module
				F55	Defog Rear
				F56	SPARE

Fuses	Usage
F57	SPARE
F58	FRNT WIPER – Front Wiper
F59	TIM 2 – Trailer Interface Module 2
F60	SPARE
F61	SPARE
F62	ELM 3 – Exterior Lighting Module 3
F63	SPARE
F64	SPARE
F65	ELM 4 – Exterior Lighting Module 4
F66	AUX PRK LAMP – Auxiliary Park Lamp
F67	SPARE
F68	HDLP LT/AUX PRK LAMP LT – Headlamp Left/Auxiliary Park Lamp Left
F69	UNDR BODY CAMERA – Underbody Camera

Fuses	Usage
F70	EBCM 1 – Electronic Brake Control Module 1
F71	DC/AC INV – DC/AC Inverter
F72	SPARE
F73	SPARE
F74	SPARE
F75	SPARE
F76	HDLP RT/AUX PRK LAMP RT – Headlamp Right/Auxiliary Parklamp Right
F77	SPARE
F78	2ND ROW LT – Second Row Fold Left
F79	SPARE
F80	FT Radar – Front Radar
F81	IEC RT 2 – Instrument Panel Fuse Block Right 2
F82	SPARE
F83	IEC LT 1 – Instrument Panel Fuse Block Left 1
F84	SPARE
F85	SPARE
F86	SPARE
F87	SPARE
F88	SPARE
F89	SPARE
F90	SPARE
F91	SPARE

Fuses	Usage
F83	SPARE
F84	SPARE
F85	HVSD – High Voltage Service Disconnect
F86	SPARE
F87	Horn
F88	FRT WSHR PMP – Front Washer
F89	RR WSHR PMP – Rear Washer
F90	CAMERA WASH MTR – Camera Wash Motor
F91	MSB/PASS – Passenger Motorized Seat Belt
F92	MSB/DRVR – Driver Motorized Seat Belt

## Instrument Panel Fuse Block (Left)



The instrument panel fuse block is on the driver side of the instrument panel, between the steering wheel and the door. To access the fuses, remove the panel, starting at the bottom. Once clips are disengaged, the tabs along the top of the door can be disengaged from the instrument panel to remove the door.

To reinstall the door, place the top tabs into the slots, and rotate the door into position, engaging the clips.



The vehicle may not be equipped with all of the fuses, relays, and features shown.

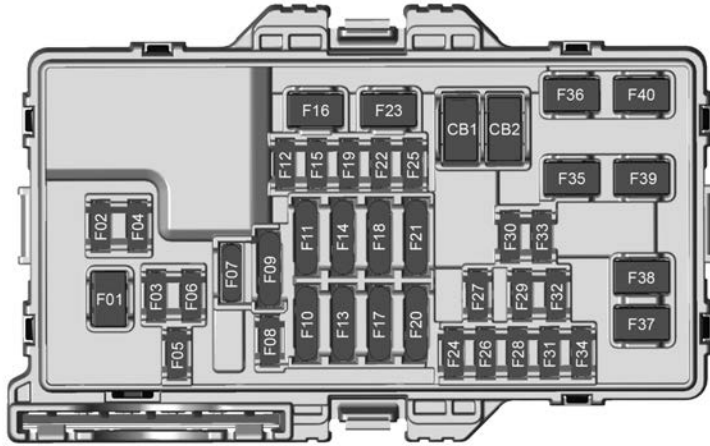

Fuses	Usage
F01	DSM – Driver Power Seat
F02	SDM/AOS – Sensing and Diagnostic Module/ Automatic Occupant Sensing
F03	VKS//TTPM/SRR – Virtual Key System/Trailer Tow Power Module/Short Range Radar

Fuses	Usage
F04	BCM 1 – Body Control Module 1
F05	ELM 5 – Exterior Lighting Module 5
F06	ENDGATE 1 – Minor End Gate
F07	SPARE
F08	TCP – Telematics Control Platform

Fuses	Usage
F09	Lumbar SPARE
F10	WCM – Wireless Charger Module HVAC Display
F11	2ND HTD SEAT – 2nd Row Heated Seat 2ND HTD SEAT – 2nd Row Heated Seat 2
F12	OUT OF PRK DSBL – Out of Park
F13	VPM – Video Process Module EOCM – External Object Calculation Module
F14	SPARE
F15	SPARE
F16	Tonneau
F17	VECM – Vehicle Extension Control Module SPARE
F18	SPARE

Fuses	Usage
F19	SPARE
F20	DRVR MSM – Memory Seat Module Driver
	SPARE
F21	DSP – Designated Seating Position
	HTD/CLD SEAT – Heated Seat Module Row 1
F22	SPARE
F23	ENDGATE 2 – End Gate Motor
F24	TPIM 1 – Traction Power Inverter Module 1
F25	SPARE
F26	TPIM 2 – Traction Power Inverter Module 2
F27	FRT HTD SEAT MDL – Heated Seat Module Row 1
F28	ELM 7 – Exterior Lighting Module 7
F29	OBS DET – Obstacle Detection

Fuses	Usage
F30	ENDGATE 2 MTR GRND – Major End Gate Motor Ground
F31	ELM 2 – Exterior Lighting Module 2
F32	RFA – Remote Function Actuator
F33	ENDGATE MTR 2 – Motor
F34	TPIM 3 – Traction Power Inverter Module 3
F35	AMP – Amplifier
F36	PASS PWR SEAT – Passenger Power Seat
F37	SPARE
F38	SPARE
F39	RT WNDW – Right Hand Power Window
F40	LT WNDW – Left Hand Power Window

Circuit Breakers	Usage
CB01	SPARE

Circuit Breakers	Usage
CB02	SPARE

## Instrument Panel Fuse Block (Right)

The instrument panel fuse block is located behind the glove box. It is accessible by removing the hush panel located underneath the glove box. To remove the hush panel, remove the 4 push-pins that secure the hush panel.

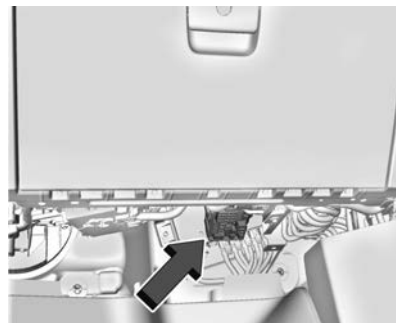

See your dealer if additional assistance is needed.

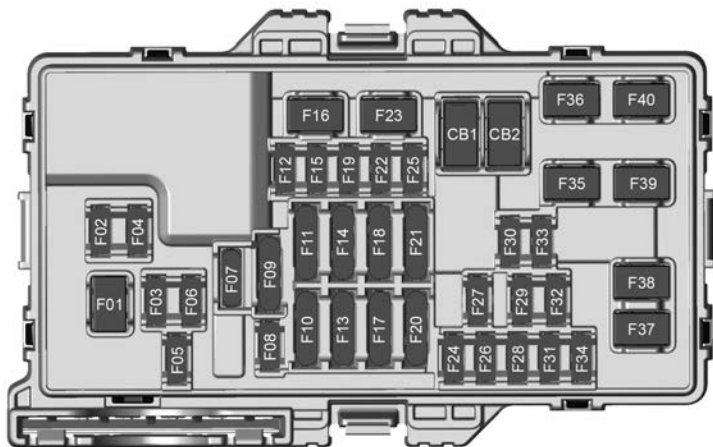

The vehicle may not be equipped with all of the fuses and relays shown.

Fuses	Usage
F01	FRT BLWR MTR – Front Blower Motor
F02	PWR STR COL MDL – Steering Column Adjust Module

Fuses	Usage
F03	ESC/SCL 1 – Electronic Transmission Range System/Steering Column Lock
F04	SPARE
F05	BCM 2 – Body Control Module 2
F06	BCM 4 – Body Control Module 4

Fuses	Usage
F07	CLOCK SPRING
F08	TBCS/EPB – Trailer Brake Control Switch/Electric Park Brake
F09	SPARE
F10	Displays NVM – Night Vision Module
F11	HDLM – High Definition Localization Module CGM – Central Gateway Module
F12	SCL 2 – Steering Column Lock
F13	TPIM 3 – Traction Power Inverter Module 3 DLC – Data Link Connection
F14	BODY ELEC – Body Electric TIM – Trailer Interface Module
F15	Driver INFO
F16	SPARE

Fuses	Usage
F17	TPIM 1 – Traction Power Inverter Module 1
	TPIM 2 – Traction Power Inverter Module 2
F18	MISC Body
	MISC IP 2 – Instrument Panel 2
F19	VICM TPIM – Vehicle Integration Control Module/Traction Power Inverter Module
F20	SPARE
F21	SPARE
F22	SPARE
F23	eTrunk™ APO – eTrunk™ Auxiliary Power Outlet
F24	RAIN SNSR/FCM – Rain Sensor/Front Camera Module
F25	AUX USB – Auxiliary USB
F26	ELM 6 – Exterior Lightning Module 6

Fuses	Usage
F27	CSM/AUX – Center Stack Module/Auxiliary Jack
F28	SPARE
F29	DMS – Driver Monitoring System
F30	SPARE
F31	BCM 3 – Body Control Module 3
F32	HSWM – Heating Steering Wheel Module
F33	SPARE
F34	SPARE
F35	SWING GATE MDL – Module-power Tailgate (Swing-gate)
F36	REAR HVAC BLWR – Rear HVAC Blower Motor
F37	SPARE
F38	SPARE
F39	SWING GATE MDL 2
F40	SPARE

Circuit Breakers	Usage
CB01	APO – Auxiliary Power Outlet Center Console
CB02	SPARE

## Wheels and Tires

### Tires

Every new GM vehicle has high-quality tires made by a leading tire manufacturer. See the warranty manual for information regarding the tire warranty and where to get service. For additional information refer to the tire manufacturer.

#### Warning

- Poorly maintained and improperly used tires are dangerous.
- Overloading the tires can cause overheating as a result of too much flexing. There could be a blowout and a serious crash. See *Vehicle Load Limits* ⇨ 176.

(Continued)

**Warning (Continued)**

- Underinflated tires pose the same danger as overloaded tires. The resulting crash could cause serious injury. Check all tires frequently to maintain the recommended pressure. Tire pressure should be checked when the tires are cold.
- Overinflated tires are more likely to be cut, punctured, or broken by a sudden impact — such as when hitting a pothole. Keep tires at the recommended pressure.
- Worn or old tires can cause a crash. If the tread is badly worn, replace them.
- Replace any tires that have been damaged by impacts with potholes, curbs, etc.
- Improperly repaired tires can cause a crash. Only your dealer or an authorized tire service center should repair, replace, dismount, and mount the tires.

(Continued)

**Warning (Continued)**

- Do not spin the tires in excess of 56 km/h (35 mph) on slippery surfaces such as snow, mud, ice, etc. Excessive spinning may cause the tires to explode.

**Winter Tires**

This vehicle was not originally equipped with winter tires. Winter tires are designed for increased traction on snow and ice-covered roads. Consider installing winter tires on the vehicle if frequent driving on ice or snow covered roads is expected. See your dealer for details regarding winter tire availability and proper tire selection. Also, see *Buying New Tires* ⇨ 328.

With winter tires, there may be decreased dry road traction, increased road noise, and shorter tread life. After changing to winter tires, be alert for changes in vehicle handling and braking.

If using winter tires:

- Use tires of the same brand and tread type on all four wheel positions.

- Use only radial ply tires of the same size, load range, and speed rating as the original equipment tires.

Winter tires with the same speed rating as the original equipment tires may not be available for H, V, W, Y, and ZR speed rated tires. If winter tires with a lower speed rating are chosen, never exceed the tire's maximum speed capability.

**All-Terrain Tires**

This vehicle may have all-terrain or mud-terrain tires. These tires provide good performance on most road surfaces, weather conditions, and for off-road driving. See *Off-Road Driving* ⇨ 166.

The tread pattern on these tires may wear more unevenly than other tires. Consider rotating the tires more frequently than at 12 000 km (7,500 mi) intervals if irregular wear is noted when the tires are inspected. See *Tire Inspection* ⇨ 326.

**Tire Sidewall Labeling**

Useful information about a tire is molded into its sidewall. The example shows a typical light truck tire sidewall.



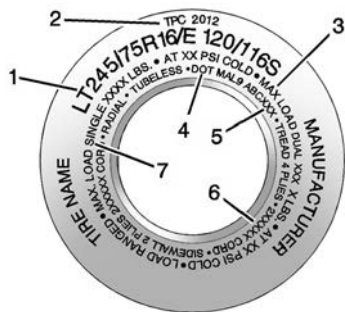

Light Truck (LT-Metric) Tire

**(1) Tire Size** : The tire size code is a combination of letters and numbers used to define a particular tire's width, height, aspect ratio, construction type, and service description. See the "Tire Size" illustration later in this section for more detail.

**(2) TPC Spec (Tire Performance Criteria Specification)** : Original equipment tires designed to GM's specific tire performance criteria have a TPC specification code molded onto the sidewall. GM's TPC specifications meet or exceed all federal safety guidelines.

**(3) Dual Tire Maximum Load** : Maximum load that can be carried and the maximum pressure needed to support that load when used in a dual configuration. For information on recommended tire pressure see *Tire Pressure* ⇨ 319 and *Vehicle Load Limits* ⇨ 176.

**(4) DOT (Department of Transportation)** : The Department of Transportation (DOT) code indicates that the tire is in compliance with the U.S. Department of Transportation Motor Vehicle Safety Standards.

**DOT Tire Date of Manufacture** : The last four digits of the TIN indicate the tire manufactured date. The first two digits represent the week and the last two digits, the year. For example, the third week of the year 2020 would have a 4-digit DOT date of 0320. Week 01 is the first full week (Sunday through Saturday) of each year.

**(5) Tire Identification Number (TIN)** : The letters and numbers following the DOT code are the Tire Identification

Number (TIN). The TIN shows the manufacturer and plant code, tire size, and date the tire was manufactured. The TIN is molded onto both sides of the tire, although only one side may have the date of manufacture.

**(6) Tire Ply Material** : The type of cord and number of plies in the sidewall and under the tread.

**(7) Single Tire Maximum Load** : Maximum load that can be carried and the maximum pressure needed to support that load when used as a single. For information on recommended tire pressure see *Tire Pressure* ⇨ 319 and *Vehicle Load Limits* ⇨ 176.

## Tire Designations

### Tire Size

The examples show a typical light truck tire size.

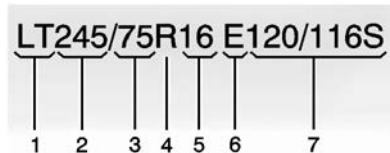

Light Truck (LT-Metric) Tire

**(1) Light Truck (LT-Metric) Tire :** The United States version of a metric tire sizing system. The letters LT as the first two characters in the tire size mean a light truck tire engineered to standards set by the U.S. Tire and Rim Association.

**(2) Tire Width :** The 3-digit number indicates the tire section width in millimeters from sidewall to sidewall.

**(3) Aspect Ratio :** A 2-digit number that indicates the tire height-to-width measurements. For example, if the tire size aspect ratio is 75, as shown in item (3) of the light truck (LT-Metric) tire illustration, it would mean that the tire's sidewall is 75 percent as high as it is wide.

**(4) Construction Code :** A letter code is used to indicate the type of ply construction in the tire. The letter R means radial ply construction; the letter D means diagonal or bias ply construction.

**(5) Rim Diameter :** Diameter of the wheel in inches.

**(6) Load Range :** Load Range.

**(7) Service Description :** The service description indicates the load index and speed rating of a tire. If two numbers are given as in the example, 120/116, then this represents the load index for single versus dual wheel usage (single/dual). The speed rating is the maximum speed a tire is certified to carry a load.

### Tire Terminology and Definitions

**Air Pressure :** The amount of air inside the tire pressing outward on each square inch of the tire. Air pressure is expressed in kPa (kilopascal) or psi (pounds per square inch).

**Aspect Ratio :** The relationship of a tire's height to its width.

**Belt :** A rubber coated layer of cords that is located between the plies and the tread. Cords may be made from steel or other reinforcing materials.

**Bead :** The tire bead contains steel wires wrapped by steel cords that hold the tire onto the rim.

**Bias Ply Tire :** A pneumatic tire in which the plies are laid at alternate angles less than 90 degrees to the centerline of the tread.

**Cold Tire Pressure :** The amount of air pressure in a tire, measured in kPa (kilopascal) or psi (pounds per square inch) before a tire has built up heat from driving. See *Tire Pressure* ⇨ 319.

**DOT Markings :** A code molded into the sidewall of a tire signifying that the tire is in compliance with the U.S. Department of Transportation (DOT) Motor Vehicle Safety Standards. The DOT code includes the Tire Identification Number (TIN), an alphanumeric designator which can also identify the tire manufacturer, production plant, brand, and date of production.

**GVWR** : Gross Vehicle Weight Rating. See *Vehicle Load Limits* ⇨ 176.

**GAWR FRT** : Gross Axle Weight Rating for the front axle. See *Vehicle Load Limits* ⇨ 176.

**GAWR RR** : Gross Axle Weight Rating for the rear axle. See *Vehicle Load Limits* ⇨ 176.

**Intended Outboard Sidewall** : The side of an asymmetrical tire, that must always face outward when mounted on a vehicle.

**Kilopascal (kPa)** : The metric unit for air pressure.

**Light Truck (LT-Metric) Tire** : A tire used on light duty trucks and some multipurpose passenger vehicles.

**Load Index** : An assigned number ranging from 1 to 279 that corresponds to the load carrying capacity of a tire.

**Maximum Inflation Pressure** : The maximum air pressure to which a cold tire can be inflated. The maximum air pressure is molded onto the sidewall.

**Maximum Load Rating** : The load rating for a tire at the maximum permissible inflation pressure for that tire.

**Occupant Distribution** : Designated seating positions.

**Outward Facing Sidewall** : The side of an asymmetrical tire that has a particular side that faces outward when mounted on a vehicle. The side of the tire that contains a whitewall, bears white lettering, or bears manufacturer, brand, and/or model name molding that is higher or deeper than the same moldings on the other sidewall of the tire.

**Passenger (P-Metric) Tire** : A tire used on passenger cars and some light duty trucks and multipurpose vehicles.

**Recommended Inflation Pressure** : Vehicle manufacturer's recommended tire inflation pressure as shown on the tire placard. See *Tire Pressure* ⇨ 319 and *Vehicle Load Limits* ⇨ 176.

**Radial Ply Tire** : A pneumatic tire in which the ply cords that extend to the beads are laid at 90 degrees to the centerline of the tread.

**Rim** : A metal support for a tire and upon which the tire beads are seated.

**Sidewall** : The portion of a tire between the tread and the bead.

**Speed Rating** : An alphanumeric code assigned to a tire indicating the maximum speed at which a tire can operate.

**Traction** : The friction between the tire and the road surface. The amount of grip provided.

**Tread** : The portion of a tire that comes into contact with the road.

**Treadwear Indicators** : Narrow bands, sometimes called wear bars, that show across the tread of a tire when only 1.6 mm (1/16 in) of tread remains. See *When It Is Time for New Tires* ⇨ 327.

**UTQGS (Uniform Tire Quality Grading Standards)** : A tire information system that provides consumers with ratings for a tire's traction, temperature, and treadwear. Ratings are determined by tire manufacturers using government testing procedures. The ratings are molded into the sidewall of the tire. See *Uniform Tire Quality Grading* ⇨ 330.

**Vehicle Capacity Weight** : The number of designated seating positions multiplied by 68 kg (150 lbs) plus the rated cargo load. See *Vehicle Load Limits* ⇨ 176.

**Vehicle Maximum Load on the Tire** : Load on an individual tire due to curb weight, accessory weight, occupant weight, and cargo weight.

**Vehicle Placard** : A label permanently attached to a vehicle showing the vehicle's capacity weight and the original equipment tire size and recommended inflation pressure. See "Tire and Loading Information Label" under *Vehicle Load Limits* ⇨ 176.

## Tire Pressure

Tires need the correct amount of air pressure to operate effectively.

### Warning

Neither tire underinflation nor overinflation is good. Underinflated tires, or tires that do not have enough air, can result in:

- Tire overloading and overheating, which could lead to a blowout
- Premature or irregular wear
- Poor handling
- Reduced fuel economy for internal combustion engine vehicles
- Reduced range for electric vehicles

Overinflated tires, or tires that have too much air, can result in:

- Unusual wear
- Poor handling
- Rough ride

(Continued)

### Warning (Continued)

- Needless damage from road hazards

The Tire and Loading Information label on the vehicle indicates the original equipment tires and the correct cold tire inflation pressures. The recommended pressure is the minimum air pressure needed to support the vehicle's maximum load carrying capacity.

For additional information regarding how much weight the vehicle can carry, and an example of the Tire and Loading Information label, see *Vehicle Load Limits* ⇨ 176. How the vehicle is loaded affects vehicle handling and ride comfort. Never load the vehicle with more weight than it was designed to carry.

### When to Check

Check the pressure of the tires once a month or more.

Do not forget the spare, if the vehicle has one. See *Full-Size Spare Tire* ⇨ 344 for additional information.

### **How to Check**

Use a good quality pocket-type gauge to check tire pressure. Proper tire inflation cannot be determined by looking at the tire. Check the tire inflation pressure when the tires are cold, meaning the vehicle has not been driven for at least three hours or no more than 1.6 km (1 mi).

Remove the valve cap from the tire valve stem. Press the tire gauge firmly onto the valve to get a pressure measurement. If the cold tire inflation pressure matches the recommended pressure on the Tire and Loading Information label, no further adjustment is necessary. If the inflation pressure is low, add air until the recommended pressure is reached. If the inflation pressure is high, press on the metal stem in the center of the tire valve to release air.

Re-check the tire pressure with the tire gauge.

Put the valve caps back on the valve stems to keep out dirt and moisture. Use only valve caps designed for the vehicle by GM. TPMS sensors could be damaged and would not be covered by the vehicle warranty.

### **Tire Pressure Monitor System**

The Tire Pressure Monitor System (TPMS) uses radio and sensor technology to check tire pressure levels. The TPMS sensors monitor the air pressure in your tires and transmit tire pressure readings to a receiver located in the vehicle.

Each tire, including the spare (if provided), should be checked monthly when cold and inflated to the inflation pressure recommended by the vehicle manufacturer on the vehicle placard or tire inflation pressure label. (If your vehicle has tires of a different size than the size indicated on the vehicle placard or tire inflation pressure label, you should determine the proper tire inflation pressure for those tires.)

As an added safety feature, your vehicle has been equipped with a tire pressure monitoring system (TPMS) that illuminates a low tire pressure telltale when one or more of your tires is significantly under-inflated.

Accordingly, when the low tire pressure telltale illuminates, you should stop and check your tires as soon as possible, and inflate them to the proper pressure. Driving on a significantly under-inflated tire causes the tire to overheat and can lead to tire failure. Under-inflation also reduces energy efficiency and tire tread life, and may affect the vehicle's handling and stopping ability.

Please note that the TPMS is not a substitute for proper tire maintenance, and it is the driver's responsibility to maintain correct tire pressure, even if under-inflation has not reached the level to trigger illumination of the TPMS low tire pressure telltale.

Your vehicle has also been equipped with a TPMS malfunction indicator to indicate when the system is not operating properly. The TPMS malfunction indicator is combined with the low tire pressure telltale. When the system detects a malfunction, the telltale will flash for approximately one minute and then remain continuously illuminated. This

sequence will continue upon subsequent vehicle start-ups as long as the malfunction exists.

When the malfunction indicator is illuminated, the system may not be able to detect or signal low tire pressure as intended. TPMS malfunctions may occur for a variety of reasons, including the installation of replacement or alternate tires or wheels on the vehicle that prevent the TPMS from functioning properly. Always check the TPMS malfunction telltale after replacing one or more tires or wheels on your vehicle to ensure that the replacement or alternate tires and wheels allow the TPMS to continue to function properly.

See *Tire Pressure Monitor Operation* ⇨ 321.

See *Radio Frequency Statement* ⇨ 374.

## Tire Pressure Monitor Operation

This vehicle may have a Tire Pressure Monitor System (TPMS). The TPMS is designed to warn the driver when a low tire pressure condition exists. TPMS sensors are mounted onto each tire and wheel assembly, excluding the spare tire and wheel assembly. The TPMS sensors monitor

the air pressure in the tires and transmit the tire pressure readings to a receiver located in the vehicle.



When a low tire pressure condition is detected, the TPMS illuminates the low tire pressure warning light located on the instrument cluster. If the warning light comes on, stop as soon as possible and inflate the tires to the recommended pressure shown on the Tire and Loading Information label. See *Vehicle Load Limits* ⇨ 176.

A message to check the pressure in a specific tire displays in the Driver Information Center (DIC). The low tire pressure warning light and the DIC warning message come on each time the vehicle is turned on until the tires are inflated to the correct inflation pressure. Using the DIC, tire pressure levels can be viewed. For additional information and details about the DIC operation and displays see *Driver Information Center (DIC)* ⇨ 116.

The low tire pressure warning light may come on in cool weather when the vehicle is first started, and then turn off as the vehicle is driven. This could be an early indicator that the air pressure is getting low and needs to be inflated to the proper pressure.

A Tire and Loading Information label, attached to your vehicle, shows the size of the original equipment tires and the correct inflation pressure for the tires when they are cold. See *Vehicle Load Limits* ⇨ 176, for an example of the Tire and Loading Information label and its location. Also see *Tire Pressure* ⇨ 319.

The TPMS can warn about a low tire pressure condition but it does not replace normal tire maintenance. See *Tire Inspection* ⇨ 326, *Tire Rotation* ⇨ 326, and *Tires* ⇨ 314.

### Caution

Tire sealant materials are not all the same. A non-approved tire sealant could damage the TPMS sensors. TPMS sensor damage caused by using an incorrect tire sealant is not covered by the vehicle warranty. Always use only the GM approved tire sealant available through your dealer or included in the vehicle.

Factory-installed Tire Inflator Kits use a GM-approved liquid tire sealant. Using non-approved tire sealants could damage the TPMS sensors. See *Tire Sealant and Compressor Kit* ⇨ 333 for information regarding the inflator kit materials and instructions.

### TPMS Malfunction Light and Message

The TPMS will not function properly if one or more of the TPMS sensors are missing or inoperable. When the system detects a malfunction, the low tire pressure warning light flashes for about one minute and then stays on for the remainder of the time the vehicle is on. A DIC warning message also displays. The malfunction light and DIC warning message will come on each time the vehicle is turned on until the problem is corrected. Some of the conditions that can cause these to come on are:

- One of the road tires has been replaced with the spare tire. The spare tire does not have a TPMS sensor. The malfunction light and DIC message should go off after the road tire is replaced and the sensor matching process is performed successfully. See "TPMS Sensor Matching Process" later in this section.

- The TPMS sensor matching process was not done or not completed successfully after rotating the tires. The malfunction light and the DIC message should go off after successfully completing the sensor matching process. See "TPMS Sensor Matching Process" later in this section.
- One or more TPMS sensors are missing or damaged. The malfunction light and the DIC message should go off when the TPMS sensors are installed and the sensor matching process is performed successfully. See your dealer for service.
- Replacement tires or wheels do not match the original equipment tires or wheels. Tires and wheels other than those recommended could prevent the TPMS from functioning properly. See *Buying New Tires* ⇨ 328.
- Operating electronic devices or being near facilities using radio wave frequencies similar to the TPMS could cause the TPMS sensors to malfunction.

If the TPMS is not functioning properly it cannot detect or signal a low tire pressure condition. See your dealer for service if the TPMS malfunction light and DIC message come on and stay on.

### Tire Fill Alert (If Equipped)

This feature provides visual and audible alerts outside the vehicle to help when inflating an underinflated tire to the recommended cold tire pressure.

When the low tire pressure warning light comes on:

1. Park the vehicle in a safe, level place.
2. Set the parking brake firmly.
3. Place the vehicle in P (Park).
4. Add air to the tire that is underinflated. The turn signal lamp will flash.

When the recommended pressure is reached, the horn sounds once and the turn signal lamp will stop flashing and briefly turn solid.

Repeat these steps for all underinflated tires that have illuminated the low tire pressure warning light.

#### **Warning**

Overinflating a tire could cause the tire to rupture and you or others could be injured. Do not exceed the maximum

(Continued)

**Warning (Continued)**

pressure listed on the tire sidewall. See *Tire Sidewall Labeling* ⇨ 315 and *Vehicle Load Limits* ⇨ 176.

If the tire is overinflated by more than 35 kPa (5 psi), the horn will sound multiple times and the turn signal lamp will continue to flash for several seconds after filling stops. To release and correct the pressure, while the turn signal lamp is still flashing, briefly press the center of the valve stem. When the recommended pressure is reached, the horn sounds once.

If the turn signal lamp does not flash within 15 seconds after starting to inflate the tire, the tire fill alert has not been activated or is not working.

If the hazard warning flashers are on, the tire fill alert visual feedback will not work properly.

The TPMS will not activate the tire fill alert properly under the following conditions:

- There is interference from an external device or transmitter.
- The air pressure from the inflation device is not sufficient to inflate the tire.

- There is a malfunction in the TPMS.
- There is a malfunction in the horn or turn signal lamps.
- The identification code of the TPMS sensor is not registered to the system.
- The battery of the TPMS sensor is low.

If the tire fill alert does not operate due to TPMS interference, move the vehicle about 1 m (3 ft) back or forward and try again.

If the tire fill alert feature is not working, use a tire pressure gauge to confirm tire pressure.

**Air Down Mode**

Air Down Mode allows the driver to set a custom tire pressure for better traction during off-road driving. Visual and audible alerts outside of the vehicle will alert the driver when the desired tire pressure has been reached.

To enable Air Down Mode:

1. Park the vehicle in a safe, level place.
2. Place the vehicle in P (Park).
3. Place the vehicle in ON/RUN or press and hold the POWER button for more than five seconds. See *Power Button* ⇨ 180.
4. Touch the Off-Road app icon on the infotainment home page.

5. Touch the Air Down Mode icon.
6. Select the target pressure, then press START.
7. Choose which tire to deflate. Remove the valve cap, then press and hold the tire valve stem.

During tire deflation, the turn signal lamp closest to the tire being deflated will start flashing.

When the target pressure you selected in step 6 is reached, the horn sounds once and the turn signal lamp will stop flashing and turn solid for several seconds before turning off. Replace the valve cap. Wait for the turn signal lamp to turn off before deflating the next tire. If you deflate the next tire while the turn signal lamp is still on, the Air Down Mode will not work properly.

Repeat step 7 until all tires have been deflated. Same steps can be followed for inflating all tires to target pressure.

While in Air Down Mode, after all tires have been deflated lower than the vehicle's recommended tire pressure, the low tire pressure warning light and the DIC warning message may come on for all tires.



Due to late air adjustment in a tire, the tire pressure may change by 4 to 8 kpa (0.6 to 1.2 psi) after a few minutes, once you have stopped deflation.

Ensure that the target pressure you select is above or below your vehicle's current tire pressures by at least 20 kpa (3 psi).

If the tire is underinflated or overinflated by more than 35 kPa (5 psi) from the target pressure you selected in step 6, the horn will sound multiple times and the turn signal lamp will continue to flash for several seconds after tire pressure adjustment stops. To correct the pressure, while the turn signal lamp is still flashing, add air to inflate the tire or briefly press the center of the valve stem to deflate the tire. When the target pressure you selected in step 6 is reached, the horn sounds once and the turn signal lamp will stop flashing and turn solid for several seconds before turning off.

If the turn signal lamp does not flash within 15 seconds after starting to inflate the tire, the Air Down Mode has not been activated or is not working.

If the hazard warning flashers are on, the Air Down Mode visual feedback will not work properly.

The Air Down Mode will not work properly under the following conditions:

- There is interference from an external device or transmitter.
- The air pressure from the inflation device is not sufficient to inflate the tire.
- There is a malfunction in the TPMS.
- There is a malfunction in the horn or turn signal lamps.
- The identification code of the TPMS sensor is not registered to the system.
- The battery of the TPMS sensor is low.
- The vehicle is not in P (Park).
- The vehicle is off.
- The customer did not press START after selecting the target tire pressure in the Air Down Mode app.

If the Air Down Mode does not operate due to TPMS interference, move the vehicle about 1 m (3 ft) back or forward and try again. If the Air Down Mode is not working, use a tire pressure gauge to confirm tire pressure.

### **Warning**

Neither tire underinflation nor overinflation is good. Underinflated tires, or tires that do not have enough air, can result in:

- Tire overloading and overheating, which could lead to a blowout
- Premature or irregular wear
- Poor handling
- Reduced fuel economy for internal combustion engine vehicles
- Reduced range for electric vehicles

Overinflated tires, or tires that have too much air, can result in:

- Unusual wear
- Poor handling
- Rough ride
- Needless damage from road hazards

After off-road use, inflate all tires to the recommended pressure shown on the Tire and Loading Information label. See *Vehicle Load Limits* ⇨ 176.

### TPMS Sensor Matching Process — Auto Learn Function

Each TPMS sensor has a unique identification code. The identification code needs to be matched to a new tire/wheel position after rotating the tires or replacing one or more of the TPMS sensors. When a tire is installed, the vehicle must be stationary for about 20 minutes before the system recalculates. The following relearn process takes up to 10 minutes, driving at a minimum speed of 20 km/h (12 mph). A dash (-) or pressure value will display in the DIC. See *Driver Information Center (DIC)* ⇨ 116. A warning message displays in the DIC if a problem occurs during the relearn process.

### Trailer Tire Pressure Monitoring Operation

If equipped, the Trailer Tire Pressure Monitoring System (TTPMS) is designed to monitor the pressure of the trailer tires and warn the driver when a low pressure condition exists. TTPMS sensors for four tires

are provided. The system can accommodate a trailer with up to six tires if additional sensors are purchased from the dealer. Also, the system can be paired with up to five individual trailers.

Prior to use, the vehicle must learn the sensors by following the learning process. See *Trailer App* ⇨ 279.

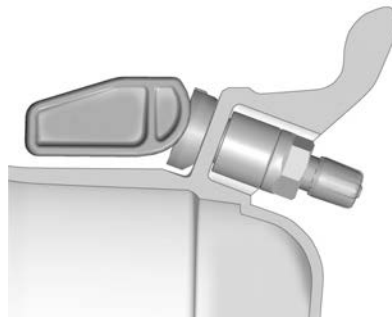

Contact your trailer service center or tire service center to have the pressure sensors installed inside the trailer tires. The technician should insert the sensor stem through the hole in the trailer wheel. When the sensor is correctly positioned, the nut on the sensor stem should be tightened to

8 N•m (6 lb ft). When mounting the trailer tire onto the trailer wheel be careful not to damage the sensor.

The Trailer App can be used to view the tire pressures after the recommended trailer tire pressures have been entered. Refer to the trailer tire placard on the trailer or the trailer tire sidewall for the recommended tire pressure.

The system is compatible with trailer tires that have placard pressure values from 103 - 689 kpa (15 - 100 psi). The hole in the wheel for the tire stem must be 11.43 mm (0.453 in) in diameter. Use of the pressure sensors on a wheel with a different stem hole size could result in loss of air from the tire.

If a low trailer tire pressure condition is detected, the TTPMS displays a warning message on the DIC. If the warning message is displayed, stop as soon as possible and inflate the tires to the recommended pressure shown on the tire placard on the trailer.

In addition, the TTPMS monitors the temperature of the trailer tires. If the system detects a high temperature on one or more of the trailer tires, a warning message will be displayed on the DIC. If this

warning message is displayed, stop as soon as possible, and inspect the overheated trailer tire. Common causes for high trailer tire temperature are underinflation, overloading, or tire damage.

### TTPMS Malfunction Message

The TTPMS will not function properly if one or more of the trailer tire sensors are missing or inoperable. If the system detects a malfunction, a DIC message indicates that the system requires service. Some of the conditions that can cause the service message to occur are:

- One of the trailer tires has been replaced with the spare tire which does not have a learned TTPMS sensor. The DIC message should turn off after the pressure sensor is installed in the tire, and the learning process is performed successfully. See "TTPMS Sensor Learning Process" under *Trailer App* ⇨ 279.
- The TTPMS sensor learning process was not done or not completed successfully. The DIC message should go off after successfully completing the sensor learning process. See "TTPMS Sensor Learning Process" under *Trailer App* ⇨ 279.

- One or more TTPMS sensors are missing or damaged. The DIC message should go off when the TTPMS sensors are installed and the sensor learning process is performed successfully. See "TTPMS Sensor Learning Process" under *Trailer App* ⇨ 279.
- Operating electronic devices or being near facilities using radio wave frequencies similar to the TTPMS could cause interference to the TTPMS which could cause loss of signal reception from the sensor.
- If the system does not receive the signal from an individual sensor, an error message may not occur until the vehicle has been driven for a period of time.

If the TTPMS is not functioning properly, it cannot detect or signal a low tire condition. See your dealer for service if the DIC message comes on and stays on when the trailer tire pressures have been checked and determined to be correct.

### Tire Inspection

We recommend that the tires, including the spare tire, if the vehicle has one, be inspected for signs of wear or damage at least once a month.

Replace the tire if:

- The indicators at three or more places around the tire can be seen.
- There is cord or fabric showing through the tire's rubber.
- The tread or sidewall is cracked, cut, or snagged deep enough to show cord or fabric.
- The tire has a bump, bulge, or split.
- The tire has a puncture, cut, or other damage that cannot be repaired well because of the size or location of the damage.

### Tire Rotation

Tires should be rotated according to the interval listed in the maintenance schedule. See *Maintenance Schedule* ⇨ 359.

Tires are rotated to achieve a more uniform wear for all tires. The first rotation is the most important.

Anytime unusual wear is noticed, rotate the tires as soon as possible, check for proper tire inflation pressure, and check

for damaged tires or wheels. If the unusual wear continues after the rotation, check the wheel alignment. See *When It Is Time for New Tires* ⇨ 327 and *Wheel Replacement* ⇨ 331.

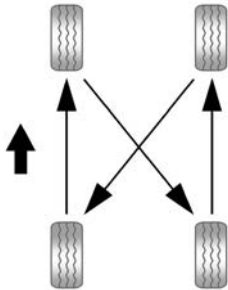

Use this rotation pattern when rotating the tires.

Do not include the spare tire in the tire rotation.

Adjust the front and rear tires to the recommended inflation pressure on the Tire and Loading Information label after

the tires have been rotated. See *Tire Pressure* ⇨ 319 and *Vehicle Load Limits* ⇨ 176.

Reset the Tire Pressure Monitor System. See *Tire Pressure Monitor Operation* ⇨ 321.

Check that all wheel nuts are properly tightened. See “Wheel Nut Torque” under *Capacities and Specifications* ⇨ 365 and “Removing the Flat Tire and Installing the Spare Tire” under *Tire Changing* ⇨ 339.

#### Warning

Rust or dirt on a wheel, or on the parts to which it is fastened, can cause wheel nuts to become loose over time. The wheel could come off and cause a crash. When changing a wheel, remove any rust or dirt from places where the wheel attaches to the vehicle. In an emergency, a cloth or paper towel can be used; however, use a scraper or wire brush later to remove all rust or dirt.

Lightly coat the inner diameter of the wheel hub opening with wheel bearing grease after a wheel change or tire rotation to prevent corrosion or rust build-up.

#### Warning

Do not apply grease to the wheel mounting surface, wheel conical seats, or the wheel nuts or bolts. Grease applied to these areas could cause a wheel to become loose or come off, resulting in a crash.

### When It Is Time for New Tires

Factors, such as maintenance, temperatures, driving speeds, vehicle loading, and road conditions affect the wear rate of the tires.

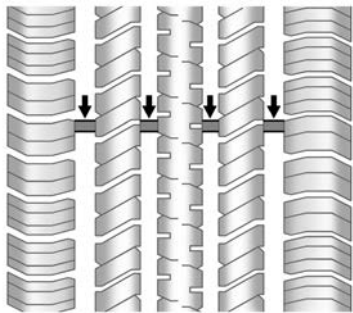

Treadwear indicators are one way to tell when it is time for new tires. Treadwear indicators appear when the tires have only 1.6 mm (1/16 in) or less of tread remaining. See *Tire Inspection* ⇨ 326 and *Tire Rotation* ⇨ 326.

The rubber in tires ages over time. This also applies to the spare tire, if the vehicle has one, even if it is never used. Multiple factors including temperatures, loading conditions, and inflation pressure maintenance affect how fast aging takes place. GM recommends that tires, including the spare if equipped, be replaced after six years, regardless of tread wear. To identify the age of a tire, use the tire manufacture date, which is the last four digits of the DOT Tire Identification

Number (TIN) molded into one side of the tire sidewall. The last four digits of the TIN indicate the tire manufacture date. The first two digits represent the week and the last two digits, the year. For example, the third week of the year 2020 would have a 4-digit DOT date of 0320. Week 01 is the first full week (Sunday through Saturday) of each year.

### Vehicle Storage

Tires age when stored normally mounted on a parked vehicle. Park a vehicle that will be stored for at least a month in a cool, dry, clean area away from direct sunlight to slow aging. This area should be free of grease, gasoline, or other substances that can deteriorate rubber.

Parking for an extended period can cause flat spots on the tires that may result in vibrations while driving. When storing a vehicle for at least a month, remove the tires or raise the vehicle to reduce the weight from the tires.

### Buying New Tires

GM has developed and matched specific tires for the vehicle. The original equipment tires installed were designed

to meet General Motors Tire Performance Criteria Specification (TPC Spec) system rating. When replacement tires are needed, GM strongly recommends buying tires with the same TPC Spec rating.

GM's exclusive TPC Spec system considers over a dozen critical specifications that impact the overall performance of the vehicle, including brake system performance, ride and handling, traction control, and tire pressure monitoring performance. GM's TPC Spec number is molded onto the tire's sidewall near the tire size. If the tires have an all-season tread design, the TPC Spec number will be followed by MS for mud and snow. See *Tire Sidewall Labeling* ⇨ 315 for additional information.

GM recommends replacing worn tires in complete sets of four. Uniform tread depth on all tires will help to maintain the performance of the vehicle. Braking and handling performance may be adversely affected if all the tires are not

replaced at the same time. If proper rotation and maintenance have been done, all four tires should wear out at about the same time. However, if it is necessary to replace only one axle set of worn tires, place the new tires on the rear axle. See *Tire Rotation* ⇨ 326.

### Warning

Tires could explode during improper service. Attempting to mount or dismount a tire could cause injury or death. Only your dealer or authorized tire service center should mount or dismount the tires.

### Warning

Mixing tires of different sizes (other than those originally installed on the vehicle), brands, tread patterns, or types may cause loss of vehicle control, resulting in a crash or other vehicle damage. Use the correct size, brand, and type of tire on all wheels.

### Warning

Using bias-ply tires on the vehicle may cause the wheel rim flanges to develop cracks after many miles of driving. A tire and/or wheel could fail suddenly and cause a crash. Use only radial-ply tires with the wheels on the vehicle.

Winter tires with the same speed rating as the original equipment tires may not be available for H, V, W, Y and ZR speed rated tires. Never exceed the winter tires' maximum speed capability when using winter tires with a lower speed rating.

If the vehicle tires must be replaced with a tire that does not have a TPC Spec number, make sure they are the same size, load range, speed rating, and construction (radial) as the original tires.

The Tire and Loading Information label indicates the original equipment tires on the vehicle. See *Vehicle Load Limits* ⇨ 176.

## Different Size Tires and Wheels

If wheels or tires are installed that are a different size than the original equipment wheels and tires, vehicle performance, including its braking, ride and handling characteristics, stability, and resistance to rollover may be affected. If the vehicle has electronic systems such as antilock brakes, rollover airbags, traction control, electronic stability control, or All-Wheel Drive, the performance of these systems can also be affected.

### Warning

If different sized wheels are used, there may not be an acceptable level of performance and safety if tires not recommended for those wheels are selected. This increases the chance of a crash and serious injury. Only use GM specific wheel and tire systems developed for the vehicle, and have them properly installed by a GM certified technician.

See *Buying New Tires* ⇨ 328 and *Accessories and Modifications* ⇨ 291.

## Uniform Tire Quality Grading

The following information relates to the system developed by the United States National Highway Traffic Safety Administration (NHTSA), which grades tires by treadwear, traction, and temperature performance. This applies only to vehicles sold in the United States. The grades are molded on the sidewalls of most passenger car tires. The Uniform Tire Quality Grading (UTQG) system does not apply to deep tread, winter tires, compact spare tires, tires with nominal rim diameters of 10 to 12 inches (25 to 30 cm), or to some limited-production tires.

While the tires available on General Motors passenger cars and light trucks may vary with respect to these grades, they must also conform to federal safety requirements and additional General Motors Tire Performance Criteria (TPC) standards.

Quality grades can be found where applicable on the tire sidewall between tread shoulder and maximum section width. For example:

**Treadwear 200 Traction AA Temperature A**  
All Passenger Car Tires Must Conform to Federal Safety Requirements In Addition To These Grades.

### Treadwear

The treadwear grade is a comparative rating based on the wear rate of the tire when tested under controlled conditions on a specified government test course. For example, a tire graded 150 would wear one and one-half (1½) times as well on the government course as a tire graded 100. The relative performance of tires depends upon the actual conditions of their use, however, and may depart significantly from the norm due to variations in driving habits, service practices and differences in road characteristics and climate.

### Traction

The traction grades, from highest to lowest, are AA, A, B, and C. Those grades represent the tire's ability to stop on wet pavement as measured under controlled conditions on specified government test surfaces of asphalt and concrete. A tire marked C may have poor traction performance. Warning: The traction grade assigned to this tire is based on straight-ahead braking traction tests, and does not include acceleration, cornering, hydroplaning, or peak traction characteristics.

### Temperature

The temperature grades are A (the highest), B, and C, representing the tire's resistance to the generation of heat and its ability to dissipate heat when tested under controlled conditions on a specified indoor laboratory test wheel. Sustained high temperature can cause the material of the tire to degenerate and reduce tire life, and excessive temperature can lead to sudden tire failure. The grade C

corresponds to a level of performance which all passenger car tires must meet under the Federal Motor Safety Standard No. 109. Grades B and A represent higher levels of performance on the laboratory test wheel than the minimum required by law. **Warning:** The temperature grade for this tire is established for a tire that is properly inflated and not overloaded. Excessive speed, underinflation, or excessive loading, either separately or in combination, can cause heat buildup and possible tire failure.

## Wheel Alignment and Tire Balance

The tires and wheels were aligned and balanced at the factory to provide the longest tire life and best overall performance. Adjustments to wheel alignment and tire balancing are not necessary on a regular basis. Consider an alignment check if there is unusual tire wear or the vehicle is significantly pulling to one side or the other. Some slight pull to the left or right, depending on the crown of the road and/or other road surface variations

such as troughs or ruts, is normal. If the vehicle is vibrating when driving on a smooth road, the tires and wheels may need to be rebalanced. See your dealer for proper diagnosis.

## Wheel Replacement

Replace any wheel that is bent, cracked, or badly rusted or corroded. If wheel nuts keep coming loose, the wheel, wheel bolts, and wheel nuts should be replaced. If the wheel leaks air, replace it. Some aluminum wheels can be repaired. See your dealer if any of these conditions exist.

Your dealer will know the kind of wheel that is needed.

Each new wheel should have the same load-carrying capacity, diameter, width, offset, and be mounted the same way as the one it replaces.

Replace wheels, wheel bolts, wheel nuts, or Tire Pressure Monitor System (TPMS) sensors with new GM original equipment parts.

### Warning

Using the wrong replacement wheels, wheel bolts, or wheel nuts can be dangerous. It could affect the braking and handling of the vehicle. Tires can lose air and cause loss of control, resulting in a crash. Always use the correct wheel, wheel bolts, and wheel nuts for replacement.

### Warning

Replacing a wheel with a used one is dangerous. How it has been used or how far it has been driven may be unknown. It could fail suddenly and cause a crash. When replacing wheels, use a new GM original equipment wheel.

### Caution

The wrong wheel can also cause problems with bearing life, brake cooling, speedometer or odometer calibration, headlamp aim, bumper height, vehicle ground clearance, and tire or tire chain clearance to the body and chassis.



## Tire Chains

### Warning

Do not use tire chains. There is not enough clearance. Tire chains used on a vehicle without the proper amount of clearance can cause damage to the brakes, suspension, or other vehicle parts. The area damaged by the tire chains could cause loss of control and a crash.

Use another type of traction device only if its manufacturer recommends it for the vehicle's tire size combination and road conditions. Follow that manufacturer's instructions. To avoid vehicle damage, drive slowly and readjust or remove the traction device if it contacts the vehicle. Do not spin the wheels. If traction devices are used, install them on the tires of the drive axle only.

## If a Tire Goes Flat

It is unusual for a tire to blow out while driving, especially if the tires are maintained properly. See *Tires* ⇨ 314. If air goes out of a tire, it is much more likely to leak out

slowly. But if there is ever a blowout, here are a few tips about what to expect and what to do:

If a front tire fails, the flat tire creates a drag that pulls the vehicle toward that side. Take your foot off the accelerator pedal and grip the steering wheel firmly. Steer to maintain lane position, and then gently brake to a stop, well off the road, if possible.

A rear blowout, particularly on a curve, acts much like a skid and may require the same correction as used in a skid. Stop pressing the accelerator pedal and steer to straighten the vehicle. It may be very bumpy and noisy. Gently brake to a stop, well off the road, if possible.

### Warning

Driving on a flat tire will cause permanent damage to the tire. Re-inflating a tire after it has been driven on while severely underinflated or flat may cause a blowout and a serious crash. Never attempt to re-inflate a tire that has been driven on while severely

(Continued)

### Warning (Continued)

underinflated or flat. Have your dealer or an authorized tire service center repair or replace the flat tire as soon as possible.

### Warning

Lifting a vehicle and getting under it to do maintenance or repairs is dangerous without the appropriate safety equipment and training. If a jack is provided with the vehicle, it is designed only for changing a flat tire. If it is used for anything else, you or others could be badly injured or killed if the vehicle slips off the jack. If a jack is provided with the vehicle, only use it for changing a flat tire.

If a tire goes flat, avoid further tire and wheel damage by driving slowly to a level place, well off the road, if possible. Turn on the hazard warning flashers. See *Hazard Warning Flashers* ⇨ 125.

If your vehicle is loaded at or near maximum cargo capacity, it may be difficult to fit the jack under the vehicle due to the environment (shoulder slope, road debris,

etc.). Removal of some weight may improve the ability to fit the jack under the vehicle at the correct jacking location.

### Warning

Changing a tire can be dangerous. The vehicle can slip off the jack and roll over or fall causing injury or death. Find a level place to change the tire. To help prevent the vehicle from moving:

1. Set the parking brake firmly.
2. Put the vehicle in P (Park).
3. Turn the vehicle off and do not restart the vehicle while it is raised.
4. Do not allow passengers to remain in the vehicle.
5. Place wheel blocks, if equipped, on both sides of the tire at the opposite corner of the tire being changed.

This vehicle may come with a jack and spare tire or a tire sealant and compressor kit. To use the jacking equipment to change a spare tire safely, follow the instructions below. Then see *Tire Changing* ⇨ 339. To use the tire sealant and compressor kit, see *Tire Sealant and Compressor Kit* ⇨ 333.

When the vehicle has a flat tire (2), use the following example as a guide to assist you in the placement of wheel blocks (1), if equipped.

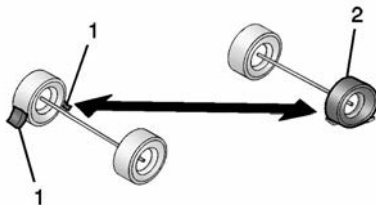

1. Wheel Block (If Equipped)
2. Flat Tire

The following information explains how to repair or change a tire.

## Tire Sealant and Compressor Kit

### Warning

Overinflating a tire could cause the tire to rupture and you or others could be injured. Be sure to read and follow the tire sealant and compressor kit

(Continued)

### Warning (Continued)

instructions and inflate the tire to its recommended pressure. Do not exceed the recommended pressure.

### Warning

Storing the tire sealant and compressor kit or other equipment in the passenger compartment of the vehicle could cause injury. In a sudden stop or collision, loose equipment could strike someone. Store the tire sealant and compressor kit in its original location.

If this vehicle has a tire sealant and compressor kit, there may not be a spare tire or tire changing equipment, and on some vehicles there may not be a place to store a tire.

The tire sealant and compressor can be used to temporarily seal punctures up to 6 mm (0.25 in) in the tread area of the tire. It can also be used to inflate an underinflated tire.

If the tire has been separated from the wheel, has damaged sidewalls, or has a large puncture, the tire is too severely

damaged for the tire sealant and compressor kit to be effective. See *Roadside Assistance Program* ⇨ 369.

Read and follow all of the tire sealant and compressor kit instructions.

The kit includes:

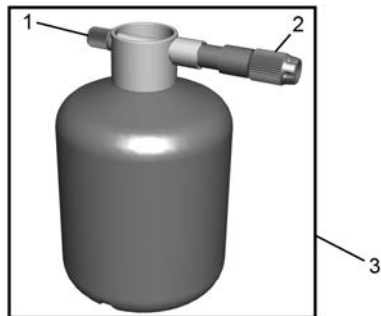

1. Sealant Canister Inlet Valve
2. Sealant/Air Hose
3. Tire Sealant Canister

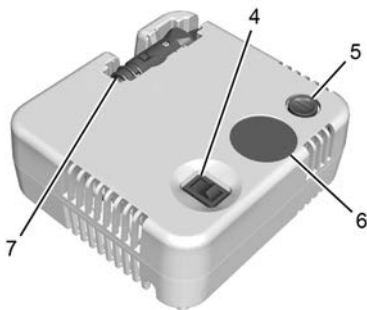

4. On/Off Button
5. Pressure Deflation Button
6. Pressure Gauge
7. Power Plug

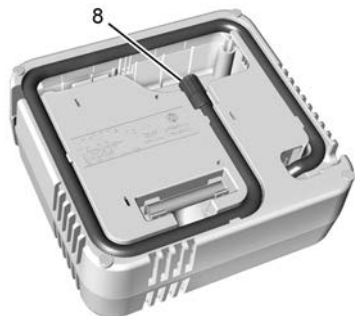

8. Air Only Hose

### Tire Sealant

Read and follow the safe handling instructions on the label adhered to the tire sealant canister (3).

Check the tire sealant expiration date on the tire sealant canister. The tire sealant canister (3) should be replaced before its expiration date. Replacement tire sealant canisters are available at your local dealer.

There is only enough sealant to seal one tire. After usage, the tire sealant canister must be replaced.

### Using the Tire Sealant and Compressor Kit to Temporarily Seal and Inflate a Punctured Tire

When using the tire sealant and compressor kit during cold temperatures, warm the kit in a heated environment for five minutes. This will help to inflate the tire faster.

If a tire goes flat, avoid further tire and wheel damage by driving slowly to a level place. Turn on the hazard warning flashers. See *Hazard Warning Flashers* ⇨ 125.

See *If a Tire Goes Flat* ⇨ 332 for other important safety warnings.

Do not remove any objects that have penetrated the tire.

1. Remove the tire sealant canister (3) and compressor from its storage location. See *Storing the Tire Sealant and Compressor Kit* ⇨ 338.
2. Remove the air only hose (8) and the power plug (7) from the compressor.
3. Place the compressor on the ground near the flat tire.

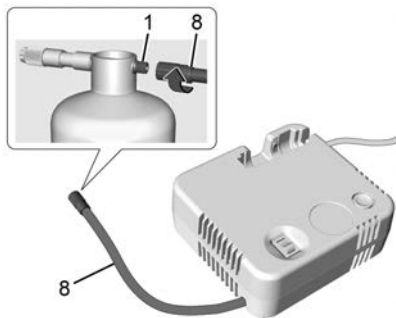

4. Remove the cap from the sealant canister inlet valve (1) by turning it counterclockwise. Attach the air only hose (8) to the sealant canister inlet valve (1) by turning it clockwise until tight.

5. Remove the valve stem cap from the flat tire by turning it counterclockwise.

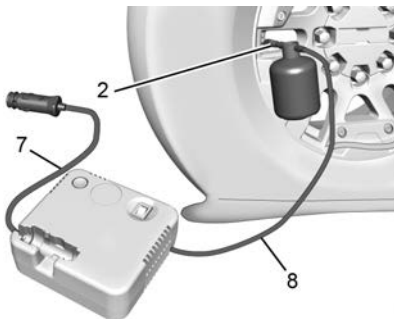

6. Attach the sealant/air hose (2) to the tire valve stem by turning it clockwise until tight.
7. Plug the power plug (7) into the accessory power outlet in the vehicle. Unplug all items from other accessory power outlets. See *Power Outlets* ⇨ 89. If the vehicle has an accessory power outlet, do not use the cigarette lighter. If the vehicle only has a cigarette lighter, use the cigarette lighter. Do not pinch the power plug cord in the door or window.

8. Start the vehicle. The vehicle must be running while using the air compressor.
9. Press the on/off button (4) to turn the tire sealant and compressor kit on. The compressor will inject sealant and air into the tire. The pressure gauge (6) will initially show a high pressure while the compressor pushes the sealant into the tire. Once the sealant is completely dispersed into the tire, the pressure will quickly drop and start to rise again as the tire inflates with air only.
10. Inflate the tire to the recommended inflation pressure using the pressure gauge (6). The recommended inflation pressure can be found on the Tire and Loading Information label. See *Tire Pressure* ⇨ 319. The pressure gauge (6) may read higher than the actual tire pressure while the compressor is on. Turn the compressor off to get an accurate pressure reading. The compressor may be turned on/off until the correct pressure is reached.

**Caution**

If the recommended pressure cannot be reached after approximately 25 minutes, the vehicle should not be driven farther. The tire is too severely damaged and the tire sealant and compressor kit cannot inflate the tire. Remove the power plug from the accessory power outlet and unscrew the inflating hose from the tire valve. See *Roadside Assistance Program* ⇨ 369.

11. Press the on/off button (4) to turn the tire sealant and compressor kit off.  
The tire is not sealed and will continue to leak air until the vehicle is driven and the sealant is distributed in the tire. Therefore, Steps 12–20 must be done immediately after Step 11.  
Be careful while handling the tire sealant and compressor kit as it could be warm after usage.
12. Unplug the power plug (7) from the accessory power outlet in the vehicle.
13. Turn the sealant/air hose (2) counterclockwise to remove it from the tire valve stem.
14. Replace the tire valve stem cap.

15. Turn the air only hose (8) counterclockwise to remove it from the tire sealant canister inlet valve (1).
16. Replace the tire sealant canister inlet valve (1) cap.
17. Return the air only hose (8) and power plug (7) back to their original storage location.



18. If the flat tire was able to inflate to the recommended inflation pressure, remove the maximum speed label from the sealant canister and place it in a highly visible location.  
Do not exceed the speed on this label until the damaged tire is repaired or replaced.
19. Return the equipment to its original storage location in the vehicle.
20. Immediately drive the vehicle 8 km (5 mi) to distribute the sealant in the tire.

21. Stop at a safe location and check the tire pressure. Refer to Steps 1–10 under “Using the Tire Sealant and Compressor Kit without Sealant to Inflate a Tire (Not Punctured).”

If the tire pressure has fallen more than 68 kPa (10 psi) below the recommended inflation pressure, stop driving the vehicle. The tire is too severely damaged and the tire sealant cannot seal the tire. See *Roadside Assistance Program* ⇨ 369.

If the tire pressure has not dropped more than 68 kPa (10 psi) from the recommended inflation pressure, inflate the tire to the recommended inflation pressure.

22. Wipe off any sealant from the wheel, tire, or vehicle.
23. Dispose of the used tire sealant canister (3) at a local dealer or in accordance with local state codes and practices.
24. Replace it with a new canister available from your dealer.
25. After temporarily sealing a tire using the tire sealant and compressor kit, take the vehicle to an authorized dealer within 161 km (100 mi) of driving to have the tire repaired or replaced.

## Using the Tire Sealant and Compressor Kit without Sealant to Inflate a Tire (Not Punctured)

The kit includes:

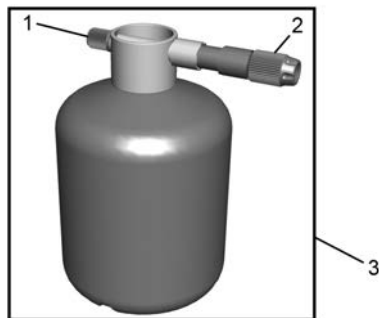

1. Sealant Canister Inlet Valve
2. Sealant/Air Hose
3. Tire Sealant Canister

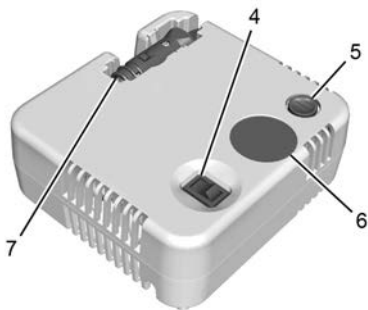

4. On/Off Button
5. Pressure Deflation Button
6. Pressure Gauge
7. Power Plug



8. Air Only Hose

If a tire goes flat, avoid further tire and wheel damage by driving slowly to a level place. Turn on the hazard warning flashers. See *Hazard Warning Flashers* ⇨ 125.

See *If a Tire Goes Flat* ⇨ 332 for other important safety warnings.

1. Remove the compressor from its storage location. See *Storing the Tire Sealant and Compressor Kit* ⇨ 338.
2. Remove the air only hose (8) and the power plug (7) from the compressor.
3. Place the compressor on the ground near the flat tire.  
Make sure the tire valve stem is positioned close to the ground so the hose will reach it.
4. Remove the valve stem cap from the flat tire by turning it counterclockwise.
5. Attach the air only hose (8) to the tire valve stem by turning it clockwise until tight.
6. Plug the power plug (7) into the accessory power outlet in the vehicle. Unplug all items from other accessory power outlets. See *Power Outlets* ⇨ 89. If the vehicle has an accessory power outlet, do not use the cigarette lighter.

If the vehicle only has a cigarette lighter, use the cigarette lighter.

Do not pinch the power plug cord in the door or window.

7. Start the vehicle. The vehicle must be running while using the air compressor.
8. Press the on/off button (4) to turn the tire sealant and compressor kit on.

The compressor will inflate the tire with air only.

9. Inflate the tire to the recommended inflation pressure using the pressure gauge (6). The recommended inflation pressure can be found on the Tire and Loading Information label. See *Tire Pressure* ⇨ 319.

The pressure gauge (6) may read higher than the actual tire pressure while the compressor is on. Turn the compressor off to get an accurate pressure reading. The compressor may be turned on/off until the correct pressure is reached.

### Caution

If the recommended pressure cannot be reached after approximately 25 minutes, the vehicle should not be driven farther.

(Continued)

### Caution (Continued)

The tire is too severely damaged and the tire sealant and compressor kit cannot inflate the tire. Remove the power plug from the accessory power outlet and unscrew the inflating hose from the tire valve. See *Roadside Assistance Program* ⇨ 369.

10. Press the on/off button (4) to turn the tire sealant and compressor kit off.  
Be careful while handling the compressor as it could be warm after usage.
11. Unplug the power plug (7) from the accessory power outlet in the vehicle.
12. Turn the air only hose (8) counterclockwise to remove it from the tire valve stem.
13. Replace the tire valve stem cap.
14. Return the air only hose (8) and power plug (7) back to their original storage location.
15. Return the equipment to its original storage location in the vehicle.

Accessory adapters that can be used to inflate an air mattress or a ball, etc., are located on the bottom of the compressor kit

## Storing the Tire Sealant and Compressor Kit

The tire sealant and compressor kit is stowed under the driver side rear seat.

1. Fold the driver side rear seat cushion up. See "Folding the Rear Seat Cushion" in *Rear Seats* ⇨ 44.



2. Turn the retainer counterclockwise to remove the tire sealant and compressor kit lid.
3. Remove the tire sealant and compressor kit from the foam holder.

To store the tire sealant and compressor kit, reverse Steps 1–3.

## Tire Changing

### Removing the Spare Tire and Tools

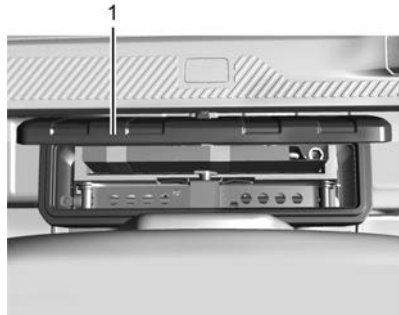
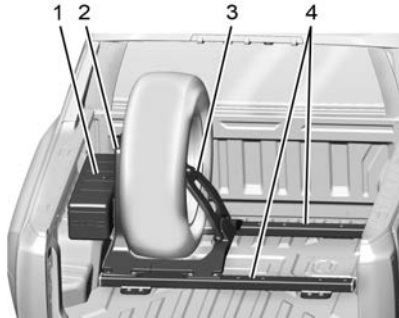

1. Toolbox

2. Spare Tire Carrier Upper Structure
3. Spare Tire Carrier Arm Assembly
4. Spare Tire Carrier Cross Rails

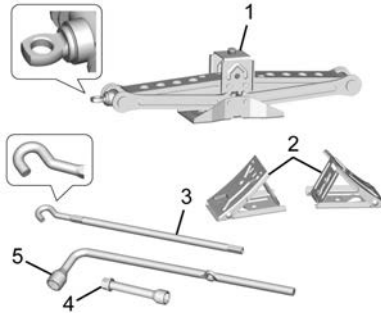

1. Jack
2. Wheel Blocks
3. Jack Handle
4. Wheel Wrench Adapter
5. Wheel Wrench

If equipped, the spare tire, carrier, jack, and tools are located in the bed of the truck. The jack and tools are stored in the toolbox attached to the spare tire carrier. To access the spare tire, jack, and tools:

1. Open the tailgate. See *Tailgate* ⇨ 19.

2. Use the toolbox key to open the toolbox and remove the jack and tools.
3. Place the jack near the tire being changed.

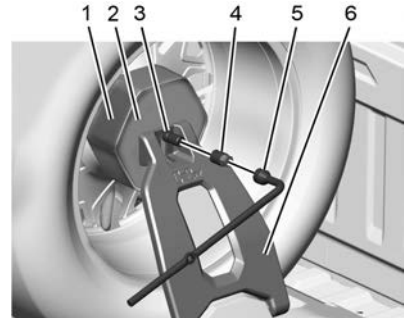

4. Align the locking lug key (4) with the locking lug nut (3), then place the wheel wrench (5) on the locking lug key.
5. Turn the wheel wrench counterclockwise to loosen and remove the locking lug nut.
6. Rotate the arm assembly (6) away from the spare tire and allow it to rest between the spare tire carrier cross rails on the truck bed.
7. Remove the hexagonal cover (2) from the bracket (1).



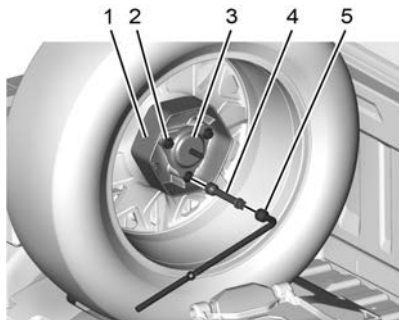

8. Using the wheel wrench (5) and wheel wrench adapter (4), turning counterclockwise, remove the three bolts (2) holding the circular plate (3). Remove the circular plate from the bracket (1).

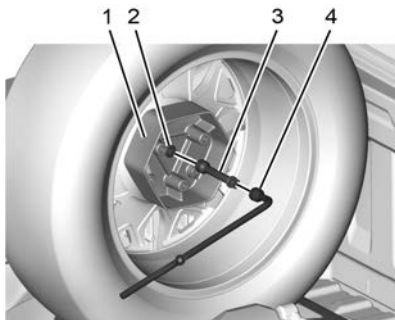

9. Using the wheel wrench (4) and wheel wrench adapter (3), turning counterclockwise, remove the main attachment bolt (2) from the center of the bracket (1).
10. Grasp the spare tire firmly and pull it out and away from the spare tire carrier.

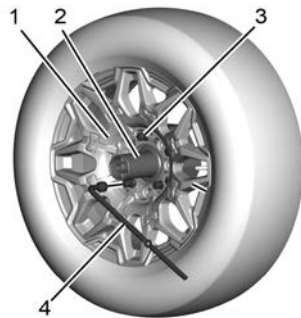

11. Using the wheel wrench (4) on the finished side of the wheel (1), turning counterclockwise, remove the three lug nuts (3) from the bracket (2). Remove the bracket.
12. Gather all loose parts and store together until needed.

### Removing the Flat Tire and Installing the Spare Tire

1. If the wheel has a center cap that covers the lug nuts, place the chisel end of the wheel wrench in each of the slots in the cap, and gently pry it out.
2. Do a safety check before proceeding. See *If a Tire Goes Flat* ⇨ 332.

**⚠ Warning**

Unexpected wheel motion and/or direction when one or more wheels are off the ground for service work may result in injury. The vehicle may:

- Allow the wheels to rotate unexpectedly in either direction regardless of mode selection.
- Allow the wheels to rotate in reaction to attempts to rotate the tire(s) manually.
- Resist attempts to rotate the wheels manually.

Before lifting the vehicle to do your own service work, turn the vehicle off or place the vehicle in the Service Mode. To place the vehicle in Service Mode, with the vehicle off and the brake pedal not applied, press and hold POWER for more than five seconds.



3. Turn the wheel wrench counterclockwise to loosen all the wheel nuts, but do not remove them yet.

**⚠ Warning**

Getting under a vehicle when it is lifted on a jack is dangerous. If the vehicle slips off the jack, you could be badly injured or killed. Never get under a vehicle when it is supported only by a jack.

**⚠ Warning**

Raising the vehicle with the jack improperly positioned can damage the vehicle and even make the vehicle fall. To help avoid personal injury and vehicle damage, be sure to fit the jack lift head into the proper location before raising the vehicle.

**⚠ Warning**

Lifting a vehicle and getting under it to do maintenance or repairs is dangerous without the appropriate safety equipment and training. If a jack is provided with the vehicle, it is designed only for changing a flat tire. If it is used for anything else, you or others could be badly injured or killed if the vehicle slips off the jack. If a jack is provided with the vehicle, only use it for changing a flat tire.

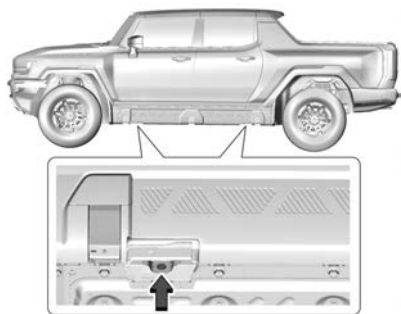

4. Position the jack lift head at the jack position nearest the flat tire.

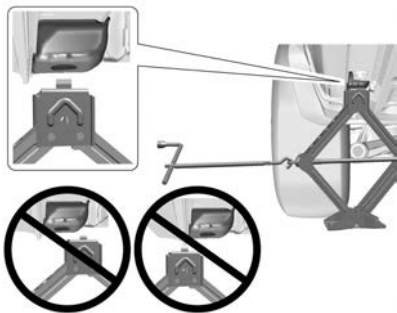

5. Attach the jack handle extension to the jack by sliding the hook through the end of the jack.

6. Raise the jack lift head until it is firmly contacting the lifting point. When properly positioned, the pin on the jack lift head fits inside the hole of the lifting point.

### Caution

Make sure that the jack lift head is in the correct position or you may damage your vehicle. The repairs would not be covered by your warranty.

7. Raise the vehicle by turning the jack handle clockwise. Raise the vehicle far enough off the ground so there is enough room for the road tire to clear the ground.

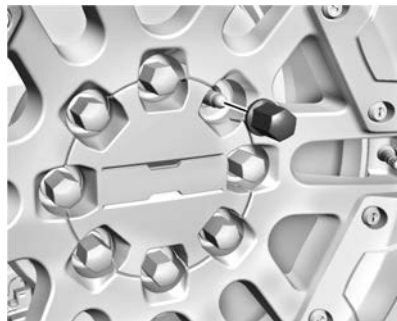

8. Remove all of the wheel nuts.  
9. Remove the tire.

### Warning

Rust or dirt on a wheel, or on the parts to which it is fastened, can cause wheel nuts to become loose over time. The wheel could come off and cause a crash. When changing a wheel, remove any rust or dirt from places where the wheel attaches to the vehicle. In an emergency, a cloth or paper towel can be used; however, use a scraper or wire brush later to remove all rust or dirt.



10. Remove any rust or dirt from the wheel bolts, mounting surfaces, and spare wheel.
11. Place the spare tire on the wheel-mounting surface.

**Warning**

Never use oil or grease on bolts or nuts because the nuts might come loose. The vehicle's wheel could fall off, causing a crash.

12. Reinstall the wheel nuts. Tighten each nut by hand until the wheel is held against the hub.
13. Lower the vehicle by turning the jack handle counterclockwise.

**Warning**

Wheel nuts that are improperly or incorrectly tightened can cause the wheels to become loose or come off. The wheel nuts should be tightened with a torque wrench to the proper torque specification after replacing. Follow the torque specification supplied by the aftermarket manufacturer when using accessory locking wheel nuts. See *Capacities and Specifications* ⇨ 365 for original equipment wheel nut torque specifications.

**Caution**

Improperly tightened wheel nuts can lead to brake pulsation and rotor damage. To avoid expensive brake repairs, evenly tighten the wheel nuts in the proper sequence and to the proper torque specification. See *Capacities and Specifications* ⇨ 365 for the wheel nut torque specification.

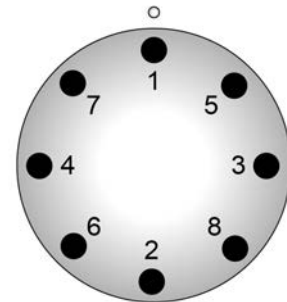

14. Tighten the wheel nuts firmly in a crisscross sequence, as shown.
15. Lower the jack all the way and remove the jack from under the vehicle.

16. Replace the lifting point cover.
17. Tighten the wheel nuts firmly with the wheel wrench.

Return the jack and tools to the toolbox and the spare or flat tire to the spare tire carrier by reversing the steps in “Removing the Spare Tire and Tools” above.

 **Warning**

Storing a jack, a tire, or other equipment in the passenger compartment of the vehicle could cause injury. In a sudden stop or collision, loose equipment could strike someone. Store all these in the proper place.

### Full-Size Spare Tire

If this vehicle came with a full-size spare tire, it was fully inflated when new, however, it can lose air over time. Check the inflation pressure regularly. See *Tire Pressure* ⇨ 319 and *Vehicle Load Limits* ⇨ 176 for information

regarding proper tire inflation and loading the vehicle. For instructions on how to remove, install, or store a spare tire, see *Tire Changing* ⇨ 339.

After installing the spare tire on the vehicle, stop as soon as possible and check that the spare is correctly inflated. The spare tire is made to perform well at speeds up to 112 km/h (70 mph) at the recommended inflation pressure, so you can finish your trip.

Have the damaged or flat road tire repaired or replaced and installed back onto the vehicle as soon as possible so the spare tire will be available in case it is needed again. Do not mix tires and wheels of different sizes, because they will not fit. Keep the spare tire and its wheel together.

If this vehicle has a spare tire that does not match the vehicle’s original road tires and wheels, in size and type, do not include the spare in the tire rotation.

## Jump Starting

### Jump Starting - North America

For more information about the vehicle battery, see *Battery - North America* ⇨ 299.

If the battery has run down, use another vehicle and some jumper cables to start the vehicle. Be sure to use the following steps to do it safely.

 **Warning**

**WARNING:** Battery posts, terminals and related accessories can expose you to chemicals including lead and lead compounds, which are known to the State of California to cause cancer and birth defects or other reproductive harm. Wash hands after handling. For more information go to [www.P65Warnings.ca.gov](http://www.P65Warnings.ca.gov).

See *California Proposition 65 Warning* ⇨ 1.

**Warning**

Batteries can hurt you. They can be dangerous because:

- They contain acid that can burn you.
- They contain gas that can explode or ignite.
- They contain enough electricity to burn you.

If you do not follow these steps exactly, some or all of these things can hurt you.

**Caution**

The vehicle is equipped with an AGM/VRLA 12-volt battery, which can be damaged by using the incorrect type of trickle charger. An AGM/VRLA-compatible charger must be used, with the appropriate setting selected. Follow the trickle charger manufacturer instructions.

**Caution**

Ignoring these steps could result in costly damage to the vehicle that would not be covered by the vehicle warranty. Trying to start the vehicle by pushing or pulling it will not work, and it could damage the vehicle.

The battery is under a cover in the underhood compartment.

To access the battery under the hood, the left cover needs to be removed.

Before you connect the cables, here are some basic things you should know. Positive (+) will go to the positive (+) terminal. Negative (-) will go to the negative (-) terminal on the battery providing the jump start to the negative grounding point for the discharged battery.

**Caution**

If the jumper cables are connected or removed in the wrong order, electrical shorting may occur and damage the vehicle. The repairs would not be covered by the vehicle warranty. Always connect  
(Continued)

**Caution (Continued)**

and remove the jumper cables in the correct order, making sure that the cables do not touch each other or other metal.

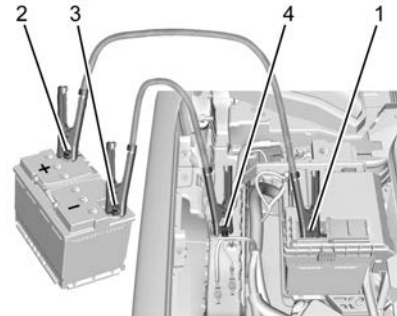

**Connection Points and Sequence**

1. Discharged Battery Positive (+) Terminal
2. Good Battery Positive (+) Terminal
3. Good Battery Negative (-) Terminal
4. Discharged Battery Negative (-) Grounding Point

The good battery positive (+) terminal and the good battery negative (-) terminal are on the battery of the vehicle providing the jump start.

The discharged battery positive (+) terminal and the discharged battery negative (-) grounding point are on the passenger side of the vehicle.

The discharged battery positive (+) terminal is under a cover. Remove the cover to expose the terminal.

1. Check the other vehicle. It must have a 12-volt battery with a negative ground system.

**Caution**

If the other vehicle does not have a 12-volt system with a negative ground, both vehicles can be damaged. Only use a vehicle that has a 12-volt system with a negative ground for jump starting.

2. Get the vehicles close enough so the jumper cables can reach, but be sure the vehicles are not touching each other. If they are, it could cause a ground connection you do not want. You would not be able to start the vehicle, and the bad grounding could damage the electrical systems.

To avoid the possibility of the vehicles rolling, set the parking brake firmly on both vehicles involved in the jump start procedure. Put the vehicles into P (Park). If the other vehicle has a manual transmission, put the vehicle in N (Neutral) before setting the parking brakes.

**Caution**

If any accessories are left on or plugged in during the jump starting procedure, they could be damaged. The repairs would not be covered by the vehicle warranty. Whenever possible, turn off or unplug all accessories on either vehicle when jump starting.

3. Turn off both vehicles. Unplug unnecessary accessories plugged into the cigarette lighter or the accessory power outlet. Turn off the radio and all lamps that are not needed. This will avoid sparks and help save both batteries. And it could save the radio!
4. Open the hood. See *Hood* ⇨ 292.

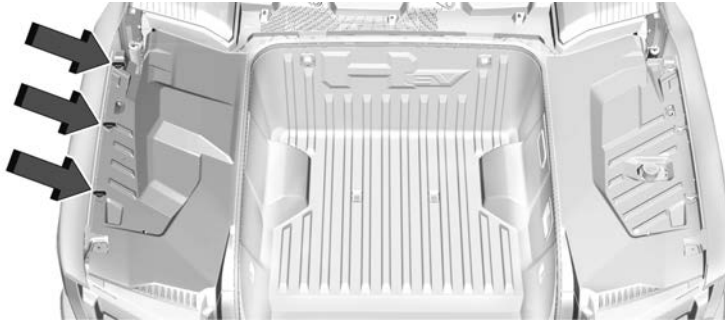

5. Turn the three bolts three quarter turn counter-clockwise and remove the left side access cover.
6. Locate the battery positive (+) terminal and negative (-) grounding point.
7. Check that the jumper cables do not have loose or missing insulation. If they do, you could get a shock. The vehicles could be damaged too.
8. Connect one end of the red positive (+) cable to the discharged battery positive (+) terminal.  
Do not let the other end touch metal.
9. Connect the other end of the red positive (+) cable to the good battery positive (+) terminal.
10. Connect one end of the black negative (-) cable to the good battery negative (-) terminal.  
Do not let the other end touch anything until the next step.
11. Connect the other end of the negative (-) cable to the discharged battery negative (-) grounding point.
12. Now start the vehicle with the good battery and keep the vehicle running for a while.
13. Try to start the vehicle that had the dead battery. If it will not start after a few tries, it probably needs service.

### Jumper Cable Removal

Reverse the sequence exactly when removing the jumper cables.

After starting the disabled vehicle and removing the jumper cables, allow it to idle for several minutes.

After removing the jumper cables, install the left side access cover by turning the three bolts three quarters clockwise.

## Towing the Vehicle

### Transporting a Disabled Vehicle

#### Caution

Incorrectly transporting a disabled vehicle may cause damage to the vehicle. Use proper tire straps to secure the vehicle to the flatbed tow truck. Do not strap or hook to any frame, underbody, or suspension component not specified below. Do not move vehicles with drive axle tires on the ground. Damage is not covered by the vehicle warranty.



**Caution**

The vehicle may be equipped with an electric parking brake and/or an electronic shifter. In the event of a loss of 12-volt battery power, the electric parking brake cannot be released, and the vehicle cannot be shifted to N (Neutral). Tire skates or dollies must be used under the non-rolling tires to prevent damage while loading/unloading the vehicle. Dragging the vehicle will cause damage not covered by the vehicle warranty.

Contact a professional towing service if the disabled vehicle must be transported. GM requires a flatbed tow truck or a trailer to transport a disabled vehicle. Use ramps to help reduce approach angles, if necessary.

Your vehicle was neither designed nor intended to be towed with any of its wheels on the ground. However, if the vehicle must be towed with its wheels on the ground to reach a safe location for loading on a flatbed tow truck or trailer, see the limitations below:

- Your vehicle is pulled facing forward.
- Your vehicle is successfully shifted to N (Neutral).

- The maximum speed of your vehicle is 20 km/h (12.4 MPH).
- The maximum distance towed is 60 km (37.3 mi).

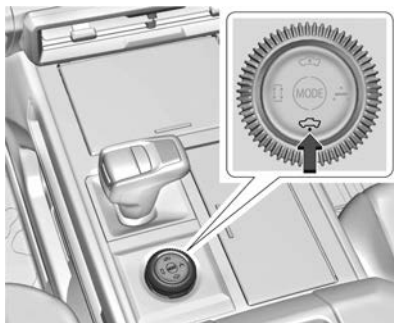
**Preparing the Vehicle:**

Before the vehicle is loaded or secured on the flat bed, with the vehicle ON, doors closed, and hood closed, use the ride height buttons to open the ride height menu. See *Air Suspension* ⇨ 201.

Select Entry/Exit Height to lower the vehicle. Once the vehicle is lowered to Entry/Exit Height, enable "Service Mode" in the infotainment screen under Settings>Vehicle>Suspension to hold the suspension in the lowered position. If 12V

power is not available, perform a jump start to temporarily provide power to put the vehicle into these modes. See *Jump Starting - North America* ⇨ 344.

If the vehicle speed exceeds 32 km/h (20 mph) after these steps, Service mode will automatically exit and the procedure will need to be repeated.

The vehicle must be in N (Neutral) and the electric parking brake must be released when loading the vehicle onto a flatbed tow truck.

- If the vehicle is equipped with car wash mode and has 12-volt battery power, refer to "Car Wash Mode" under *Electric Drive Unit* ⇨ 184 to place the vehicle in N (Neutral).
- If the 12-volt battery is dead and/or the vehicle will not start, the vehicle will not move. Try to jump start the vehicle. Refer to *Jump Starting - North America* ⇨ 344 and if the jump start is successful, retry the "Car Wash Mode" procedure. If the hood will not open, refer to *Hood* ⇨ 292 for manual hood release location.
- In the event the charging cord will not release, see "Emergency Manual Charge Cord Release" under *Plug-In Charging* ⇨ 253.

- If jump starting is unsuccessful, the vehicle will not move. Tire skates or dollies must be used under the non-rolling tires to prevent vehicle damage.

### Front Tow Hooks



The vehicle is equipped with two front tow hooks used to pull the vehicle onto a flatbed car carrier from a flat road surface. Always pull straight, do not pull sideways on the tow hooks.

### Rear Tow Hooks



If equipped, the vehicle has two rear tow hooks to pull the vehicle onto a flatbed car carrier from a flat road surface. Always pull straight, do not pull sideways on the tow hooks.

### Recreational Vehicle Towing

#### Caution

Dolly towing or dinghy towing may damage the vehicle. Always put the vehicle on a flatbed truck or trailer.

The vehicle was neither designed nor intended to be towed with any of its wheels on the ground. If your vehicle is disabled and needs to be towed, see *Transporting a Disabled Vehicle* ⇨ 347.

## Appearance Care

### Exterior Care

#### Locks

Locks are lubricated at the factory. Use a de-icing agent only when absolutely necessary, and have the locks greased after using. See *Recommended Fluids and Lubricants* ⇨ 361.

### Washing the Vehicle

To preserve the vehicle's finish, wash it often and out of direct sunlight.

#### Warning

Do not power wash any part of the vehicle's interior, including the vinyl floor covering. This could damage safety and other systems in the vehicle, which would not be covered by the vehicle warranty.

**Caution**

Do not use petroleum-based, acidic, or abrasive cleaning agents as they can damage the vehicle's paint, metal, or plastic parts. If damage occurs, it would not be covered by the vehicle warranty. Approved cleaning products can be obtained from your dealer. Follow all manufacturer directions regarding correct product usage, necessary safety precautions, and appropriate disposal of any vehicle care product.

**Caution**

Avoid using high-pressure washes closer than 30 cm (12 in) to the surface of the vehicle. Use of power washers exceeding 8 274 kPa (1,200 psi) can result in damage or removal of paint and decals.

**Cleaning Underhood Components****Caution**

Do not power wash any component under the hood that has this  symbol.

(Continued)

**Caution (Continued)**

This could cause damage that would not be covered by the vehicle warranty.

Solvents or aggressive cleaners may harm underhood components. The usages of these chemicals should be avoided.

Recommend water only.

A pressure washer may be used, but care must be utilized. The following criteria must be followed:

- Water pressure must be kept below 14 000 KPa (2,000 PSI).
- Water temperature must be below 80 °C (180 °F).
- Spray nozzle with a 40 degree wide angle spray pattern or wider must be used.
- Nozzle must be kept at least 30 cm (1 ft) away from all surfaces.

**Automatic Car Wash****Caution**

Automatic car washes can cause damage to the vehicle, wheels, ground effects, and convertible top (if equipped).

(Continued)

**Caution (Continued)**

Do not use automatic car washes due to lack of clearance for the undercarriage, wide rear tires, and wheels.

If using an automatic car wash, follow with the car wash instructions. The windshield wiper and rear window wiper, if equipped, must be turned off. Remove any accessories that may be damaged or interfere with the car wash equipment.

Rinse the vehicle well, before washing and after, to remove all cleaning agents completely. If they are allowed to dry on the surface, they could stain.

Dry the finish with a soft, clean chamois or an all-cotton towel to avoid surface scratches and water spotting.

**Finish Care**

Application of aftermarket clearcoat sealant/wax materials is not recommended.

If painted surfaces are damaged, see your dealer to have the damage assessed and repaired. Foreign materials such as calcium chloride and other salts, ice melting agents, road oil and tar, tree sap, bird droppings, chemicals from industrial chimneys, etc., can

damage the vehicle's finish if they remain on painted surfaces. Wash the vehicle as soon as possible. If necessary, use non-abrasive cleaners that are marked safe for painted surfaces to remove foreign matter.

Occasional hand waxing or mild polishing should be done to remove residue from the paint finish. See your dealer for approved cleaning products.

Do not apply waxes or polishes to uncoated plastic, vinyl, rubber, decals, simulated wood, or flat paint as damage can occur.

#### Caution

Machine compounding or aggressive polishing on a basecoat/clearcoat paint finish may damage it. Use only non-abrasive waxes and polishes that are made for a basecoat/clearcoat paint finish on the vehicle.

To keep the paint finish looking new, keep the vehicle garaged or covered whenever possible.

### Protecting Exterior Bright Metal Moldings

#### Caution

Failure to clean and protect the bright metal moldings can result in a hazy white finish or pitting. This damage would not be covered by the vehicle warranty.

The bright metal moldings on the vehicle are aluminum, chrome or stainless steel. To prevent damage always follow these cleaning instructions:

- Be sure the molding is cool to the touch before applying any cleaning solution.
- Use only approved cleaning solutions for aluminum, chrome or stainless steel. Some cleaners are highly acidic or contain alkaline substances and can damage the moldings.
- Always dilute a concentrated cleaner according to the manufacturer's instructions.
- Do not use cleaners that are not intended for automotive use.
- Use a nonabrasive wax on the vehicle after washing to protect and extend the molding finish.

### Spray-In Bedliner Care

A spray-in bedliner is a permanent coating that bonds to the truck bed and cannot be removed. Promptly rinse the bedliner surface following a chemical spill to avoid permanent damage.

Spray-in bedliners can fade from oxidation, road dirt, heavy-duty hauling, and hard water stains. Clean it periodically by washing off the loose dirt and using a mild detergent. To restore the original appearance, apply the bedliner conditioner available through your dealer.

#### Caution

Using silicone-based products may damage the bedliner, reduce the slip-resistant texture, and attract dirt.

### Cleaning Exterior Lamps/Lenses, Emblems, Decals and Stripes

Use only lukewarm or cold water, a soft cloth, and a car washing soap to clean exterior lamps, lenses, emblems, decals and stripes. Follow instructions under "Washing the Vehicle" previously in this section.

Lamp covers are made of plastic, and some have a UV protective coating. Do not clean or wipe them while they are dry.

Do not use any of the following on lamp covers:

- Abrasive or caustic agents.
- Washer fluids and other cleaning agents in higher concentrations than suggested by the manufacturer.
- Solvents, alcohols, fuels, or other harsh cleaners.
- Ice scrapers or other hard items.
- Aftermarket appearance caps or covers while the lamps are illuminated, due to excessive heat generated.

#### Caution

Failure to clean lamps properly can cause damage to the lamp cover that would not be covered by the vehicle warranty.

#### Caution

Using wax on low gloss black finish stripes can increase the gloss level and create a non-uniform finish. Clean low gloss stripes with soap and water only.

### Air Intakes

Clear debris from the air intakes, between the hood and windshield, when washing the vehicle.

### Shutter System



The vehicle may have a shutter system designed to help improve energy efficiency. Keep the shutter system clear of debris, snow and ice. If the service vehicle soon light is activated, please check to see if the shutter system is clear of debris, snow or ice.

### Windshield and Wiper Blades

Clean the outside of the windshield with glass cleaner.

Clean rubber blades using a lint-free cloth or paper towel soaked with windshield washer fluid or a mild detergent. Wash the windshield thoroughly when cleaning the blades. Bugs, road grime, sap, and a buildup of vehicle wash/wax treatments may cause wiper streaking.

Replace the wiper blades if they are worn or damaged. Damage can be caused by extreme dusty conditions, sand, salt, heat, sun, snow, and ice.

### Weatherstrips

Apply weatherstrip lubricant on weatherstrips to make them last longer, seal better, and not stick or squeak. Lubricate weatherstrips once a year. Hot, dry climates may require more frequent application. Black marks from rubber material on painted surfaces can be removed by rubbing with a clean cloth. See *Recommended Fluids and Lubricants* ⇨ 361.

### Tires

Use a stiff brush with tire cleaner to clean the tires.

**Caution**

Using petroleum-based tire dressing products on the vehicle may damage the paint finish and/or tires. When applying a tire dressing, always wipe off any overspray from all painted surfaces on the vehicle.

**Wheels and Wheel Trim**

Use a soft, clean cloth with mild soap and water to clean the wheels. After rinsing thoroughly with clean water, dry with a soft, clean towel. A wax may then be applied.

**Caution**

Chrome wheels and chrome wheel trim may be damaged if the vehicle is not washed after driving on roads that have been sprayed with magnesium chloride or calcium chloride. These are used on roads for conditions such as dust and ice. Always wash the chrome with soap and water after exposure.

**Caution**

To avoid surface damage on wheels and wheel trim, do not use strong soaps, chemicals, abrasive polishes, cleaners, or brushes. Use only GM approved cleaners. Do not drive the vehicle through an automatic car wash that uses silicon carbide tire/wheel cleaning brushes. Damage could occur and the repairs would not be covered by the vehicle warranty.

**Brake System**

Visually inspect brake lines and hoses for proper hook-up, binding, leaks, cracks, chafing, etc. Inspect disc brake pads for wear and rotors for surface condition. Inspect drum brake linings/shoes for wear or cracks. Inspect all other brake parts.

**Steering, Suspension, and Chassis Components**

Visually inspect steering, suspension, and chassis components for damaged, loose, or missing parts or signs of wear at least once a year.

Inspect power steering for proper attachment, connections, binding, cracks, chafing, etc.

Visually check constant velocity joint boots and axle seals for leaks.

**Caution**

Lubrication of applicable suspension points should not be done unless the temperature is  $-12^{\circ}\text{C}$  ( $10^{\circ}\text{F}$ ) or higher, or damage could result.

**Body Component Lubrication**

Lubricate all key lock cylinders, hood hinges, liftgate hinges, and the charge port door hinge unless the components are plastic. Applying silicone grease on weatherstrips with a clean cloth will make them last longer, seal better, and not stick or squeak.

**Underbody Maintenance**

At least twice a year, spring and fall, use plain water to flush any corrosive materials from the underbody. Take care to thoroughly clean any areas where mud and other debris can collect.

### Sheet Metal Damage

If the vehicle is damaged and requires sheet metal repair or replacement, make sure the body repair shop applies anti-corrosion material to parts repaired or replaced to restore corrosion protection.

Original manufacturer replacement parts will provide the corrosion protection while maintaining the vehicle warranty.

### Finish Damage

Quickly repair minor chips and scratches with touch-up materials available from your dealer to avoid corrosion. Larger areas of finish damage can be corrected in your dealer's body and paint shop.

### Chemical Paint Spotting

Airborne pollutants can fall upon and attack painted vehicle surfaces causing blotchy, ring-shaped discolorations, and small, irregular dark spots etched into the paint surface. See "Finish Care" previously in this section.

### Interior Care

To prevent dirt particle abrasions, regularly clean the vehicle's interior. Before using cleaners, read and follow all safety

instructions on the label. While cleaning the interior, open the doors and windows to get proper ventilation. Newspapers or dark garments can transfer color to the vehicle's interior.

#### Caution

Immediately remove cleaners, hand lotions, sunscreen, and insect repellent from all interior surfaces or permanent damage may result.

#### Caution

Use cleaners specifically designed for the surfaces being cleaned to prevent permanent damage to the vehicle. Apply all cleaners directly to a cleaning cloth. Do not spray cleaners on any switches or controls.

When using liquid soap cleaners, follow the directions on the specific cleaner or soap solution for dilution instructions.

#### Caution

To prevent damage:

- Never use a razor or any other sharp object to remove soil from any interior surface
- Never use a brush with stiff bristles.
- Never rub any surface aggressively or with too much pressure.
- Do not get any exposed electrical components wet.
- Do not use laundry detergents or dishwashing soaps with degreasers. Do not use solutions that contain strong or caustic soap.
- Do not heavily saturate the upholstery when cleaning.
- Do not use solvents or cleaners containing solvents.
- Do not use disinfecting wipes that are scented or contain bleach. Do not use wipes or cleaners that show a color transfer to the wipe or change the appearance of the interior surface when used.

(Continued)

**Caution (Continued)**

- Do not use scented or gel-type hand sanitizers. If hand sanitizer comes in contact with interior surfaces of the vehicle, blot immediately and clean with a soft cloth dampened with a mild soap and water solution.

**Interior Glass**

To clean, use a microfiber cloth fabric dampened with water. Wipe droplets left behind with a clean dry cloth. If necessary, use a commercial glass cleaner after cleaning with plain water.

**Caution**

To prevent scratching, never use abrasive cleaners on automotive glass. Abrasive cleaners or aggressive cleaning may damage the rear window defogger.

Cleaning the windshield with water during the first three to six months of ownership will reduce tendency to fog.

**Speaker Covers**

Vacuum around a speaker cover gently, so that the speaker will not be damaged. Clean spots with water and mild soap.

**Coated Moldings**

Coated moldings should be cleaned.

- When lightly soiled, wipe with a sponge or soft, lint-free cloth dampened with water.
- When heavily soiled, use warm soapy water.

**Vinyl/Rubber**

If equipped with vinyl floor and rubber floor mats, use a soft cloth and/or brush dampened with water to remove dust and loose dirt. For more thorough cleaning, use a mild soap and water solution.

**Warning**

Do not use cleaners that contain silicone, wax-based products, or cleaners that increase gloss on vinyl/rubber floor and mats. These cleaners can permanently change the appearance and feel of the vinyl/rubber and can make the floor slippery. Your foot could slip while operating the vehicle, and you could lose control, resulting in a crash. You or others could be injured.

**Fabric/Carpet/Suede**

Start by vacuuming the surface using a soft brush attachment. If a rotating vacuum brush attachment is being used, only use it on the floor carpet. Before cleaning, gently remove as much of the soil as possible:

- Gently blot liquids with a paper towel. Continue blotting until no more soil can be removed.
- For solid soils, remove as much as possible prior to vacuuming.

To clean:

1. Saturate a clean, lint-free colorfast cloth with water. Microfiber cloth is recommended to prevent lint transfer to the fabric or carpet.
2. Remove excess moisture by gently wringing until water does not drip from the cleaning cloth.
3. Start on the outside edge of the soil and gently rub toward the center. Fold the cleaning cloth to a clean area frequently to prevent forcing the soil into the fabric.
4. Continue gently rubbing the soiled area until there is no longer any color transfer from the soil to the cleaning cloth.



5. If the soil is not completely removed, use a mild soap solution followed only by plain water.

If the soil is not completely removed, it may be necessary to use a commercial upholstery cleaner or spot lifter. Test a small hidden area for colorfastness before using a commercial upholstery cleaner or spot lifter. If ring formation occurs, clean the entire fabric or carpet.

After cleaning, use a paper towel to blot excess moisture.

### Cleaning High Gloss Surfaces and Vehicle Information and Radio Displays

Use a microfiber cloth on high gloss surfaces or vehicle displays. First, use a soft bristle brush to remove dirt that can scratch the surface. Then gently clean by rubbing with a microfiber cloth. Never use window cleaners or solvents. Periodically hand wash the microfiber cloth separately, using mild soap. Do not use bleach or fabric softener. Rinse thoroughly and air dry before next use.

#### Caution

Do not attach a device with a suction cup to the display. This may cause damage and would not be covered by the vehicle warranty.

### Instrument Panel, Leather, Vinyl, Other Plastic Surfaces, Low Gloss Paint Surfaces, and Natural Open Pore Wood Surfaces

Use a soft bristle brush to remove dust from knobs and crevices on the instrument cluster. Use a soft microfiber cloth dampened with water to remove dust and loose dirt. For a more thorough cleaning, use a soft microfiber cloth dampened with a mild soap and water solution.

#### Caution

Soaking or saturating leather, especially perforated leather, as well as other interior surfaces, may cause permanent damage. Wipe excess moisture from these surfaces after cleaning and allow them to dry naturally. Never use heat, steam, or spot removers. Do not use liquids that contain alcohol or solvents on

(Continued)

#### Caution (Continued)

leather seats. Do not use cleaners that contain silicone or wax-based products. Cleaners containing these solvents can permanently change the appearance and feel of leather or soft trim, and are not recommended.

Do not use cleaners that increase gloss, especially on the instrument panel. Reflected glare can decrease visibility through the windshield under certain conditions.

#### Caution

Use of air fresheners may cause permanent damage to plastics and painted surfaces. If an air freshener comes in contact with any plastic or painted surface in the vehicle, blot immediately and clean with a soft cloth dampened with a mild soap solution. Damage caused by air fresheners would not be covered by the vehicle warranty.

### Care of Seat Belts

Keep belts clean and dry.

**⚠ Warning**

Do not bleach or dye seat belt webbing. It may severely weaken the webbing. In a crash, they might not be able to provide adequate protection. Clean and rinse seat belt webbing only with mild soap and lukewarm water. Allow the webbing to dry.

**Floor Mats****⚠ Warning**

If a floor mat is the wrong size or is not properly installed, it can interfere with the pedals. Interference with the pedals can cause unintended acceleration and/or increased stopping distance which can cause a crash and injury. Make sure the floor mat does not interfere with the pedals.

Use the following guidelines for proper floor mat use:

- The original equipment floor mats are designed for your vehicle. If the floor mats need to be replaced, it is recommended that GM-certified floor

mats are purchased. Non-GM floor mats may not fit properly and may interfere with the pedals. Always check that the floor mats do not interfere with the pedals.

- Do not use a floor mat if the vehicle is not equipped with a floor mat retainer on the driver side floor.
- Use the floor mat with the correct side up. Do not turn it over.
- Do not place anything on top of the driver side floor mat.
- Use only a single floor mat on the driver side.
- Do not place one floor mat on top of another.

**Removing and Replacing the Floor Mats**

Pull up on the rear of the floor mat to unlock each retainer and remove.

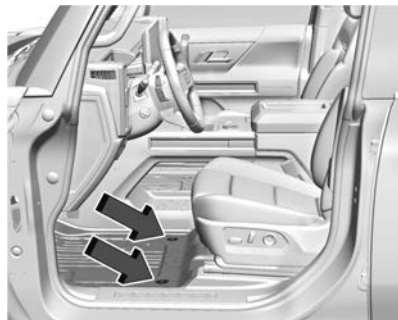

Reinstall by lining up the floor mat retainer openings over the carpet retainers and snap into position.

Make sure the floor mat is properly secured in place.

Verify the floor mat does not interfere with the pedals.

**Cleaning Rubber Floor Mats (All-Weather Mats and Floor Liners)**

See “Vinyl/Rubber” under *Interior Care* ⇨ 354 for important cleaning information.

## Service and Maintenance

### General Information

General Information ..... 358

### Maintenance Schedule

Maintenance Schedule ..... 359

### Multi-Point Vehicle Inspection (MPVI)

Multi-Point Vehicle  
Inspection (MPVI) ..... 360

### Owner Checks and Services

Owner Checks and Services ..... 360

### Recommended Fluids, Lubricants, and Parts

Recommended Fluids and Lubricants ... 361  
Maintenance Replacement Parts ..... 362

### Maintenance Records

Maintenance Records ..... 363

## General Information

Your vehicle is an important investment. This section describes the required maintenance for the vehicle. Follow this schedule to help protect against major repair expenses resulting from neglect or inadequate maintenance. It may also help to maintain the value of the vehicle if it is sold. It is the responsibility of the owner to have all required maintenance performed.

Your dealer has trained technicians who can perform required maintenance using genuine replacement parts. They have up-to-date tools and equipment for fast and accurate diagnostics. Many dealers have extended evening and Saturday hours, courtesy transportation, and online scheduling to assist with service needs.

Your dealer recognizes the importance of providing competitively priced maintenance and repair services. With trained technicians, the dealer is the place for routine maintenance such as tire rotations and additional maintenance items like tires, brakes, batteries, and wiper blades.

### Caution

Damage caused by improper maintenance can lead to costly repairs and may not be covered by the vehicle warranty. Maintenance intervals, checks, inspections, recommended fluids, and lubricants are important to keep the vehicle in good working condition.

Do not have chemical flushes that are not approved by GM performed on the vehicle. The use of flushes, solvents, cleaners, or lubricants that are not approved by GM could damage the vehicle, requiring expensive repairs that are not covered by the vehicle warranty.

The Tire Rotation and Required Services are the responsibility of the vehicle owner. It is recommended to have your dealer perform these services every 12 000 km/7,500 mi. Proper vehicle maintenance helps to keep the vehicle in good working condition.

The Additional Required Services are for vehicles that:

- Carry passengers and cargo within recommended limits on the Tire and Loading Information label. See *Vehicle Load Limits* ⇨ 176.

- Are driven on reasonable road surfaces within legal driving limits.

### Warning

Performing maintenance work can be dangerous and can cause serious injury. Perform maintenance work only if the required information, proper tools, and equipment are available. If they are not, see your dealer to have a trained technician do the work. See *Doing Your Own Service Work* ⇨ 291.

## Maintenance Schedule

### Rotate Tires and Perform Required Services Every 12 000 km (7,500 mi)

Tires are rotated to achieve a more uniform wear for all tires. The first rotation is the most important.

Anytime unusual wear is noticed, rotate the tires as soon as possible, check for proper tire inflation pressure, and check for damaged tires or wheels. If the unusual wear continues after the rotation, check the wheel alignment. See *When It Is Time for New Tires* ⇨ 327 and *Wheel Replacement* ⇨ 331.

- Perform Multi-Point Vehicle Inspection. See *Multi-Point Vehicle Inspection (MPVI)* ⇨ 360.
- Lubricate body components. See *Exterior Care* ⇨ 349.

### Additional Required Services — Normal Service

#### Every 36 000 km (22,500 mi)

- Replace passenger compartment air filter. Or every two years, whichever comes first. More frequent passenger compartment air filter replacement may be needed if driving in areas with heavy traffic, poor air quality, high dust levels, or environmental allergens. Passenger compartment air filter replacement may also be needed if there is reduced airflow, window fogging, or odors. Your GM dealer can help determine when to replace the filter.

#### Every 240 000 km (150,000 mi)

- Drain and fill vehicle coolant circuits. Or every five years, whichever comes first. See *Cooling System* ⇨ 296.

### Severe Conditions Requiring More Frequent Maintenance\*

- Mainly driven in heavy city traffic in hot weather.
- Mainly driven in hilly or mountainous terrain.
- Frequently towing a trailer.
- Used for high speed or competitive driving.
- Used for taxi, police, or delivery service.

### Additional Required Services — Severe Service

#### Every 72 000 km (45,000 mi)

- Change electric drive unit fluid. See *Recommended Fluids and Lubricants* ⇨ 361.

### Owner Checks and Services

#### Every Five Years

- Replace brake fluid every five years. See *Brake Fluid* ⇨ 298.

#### Every Seven Years

- Replace Air Conditioning Desiccant every seven years. The air conditioning system requires maintenance every seven years. This service requires replacement of the desiccant to help the longevity and

efficient operation of the air conditioning system. This service can be complex. See your dealer.

## Multi-Point Vehicle Inspection (MPVI)

A Multi Point Vehicle Inspection (MPVI) completed by a GM dealer technician is a maintenance assessment of your vehicle. The benefit of the MPVI is to identify and inform the customer of service items that require immediate attention and those that may require attention in the future.

The technician will perform the following checks on your vehicle. For a complete list of checks, inspections, and services, see your dealer.

Some items may not apply to your vehicle and/or region.

### Diagnostics

- OnStar active, if equipped
- Service history/recall check

### Exterior Lights

- Visual inspection

### Windshield and Wipers

- Visual inspection

### Battery

- Battery visual inspection
- Battery test results
- Battery cables and connections

### Systems, Fluids, and Visible Leak Inspection

- Electric Drive Unit
- Drive axle
- Transfer case
- Power electronics cooling system
- Windshield washer fluid

### Tire Inspection

- Tire pressure, tread depth, and wear
- Rotation, if applicable
- Alignment check, optional
- Reset tire pressure monitor
- Check tire sealant expiration date, if equipped
- Check spare tire, if equipped

### Brakes

- Check brake system

### Visible and Functional Inspections

- Seat belt components
- Accelerator pedal
- Passenger compartment air filter, if equipped
- Hoses
- Shocks and struts
- Steering components
- Axle boots or driveshaft and u-joints
- Compartment lift struts, if equipped
- Floor mats secured, no interference with pedals
- Horn
- Starter switch

### Lubricate

- Chassis components

## Owner Checks and Services

- At least twice a year, have underbody flushing service performed. See "Underbody Maintenance" in *Exterior Care*  
⇨ 349.

## Recommended Fluids, Lubricants, and Parts

### Recommended Fluids and Lubricants

Fluids and lubricants identified below by name or specification, including fluids or lubricants not listed here, can be obtained from your dealer.

Usage	Fluid/Lubricant
Electric Drive Unit	DEXRON ULV Automatic Transmission Fluid.
Hydraulic Brake System	GM approved DOT 4 Hydraulic Brake Fluid.
Key Lock Cylinders, Hood and Tailgate/Swing Gate Hinges	Multi-Purpose Lubricant, Superlube. See your dealer.
Vehicle Coolant Circuits	Use only ACDelco Premix (50/50 mixture of de-ionized water and DEX-COOL Coolant). See your dealer.
Windshield Washer	Automotive windshield washer fluid that meets regional freeze protection requirements.

**Maintenance Replacement Parts**

Replacement parts identified below by name, part number, or specification can be obtained from your dealer.

<b>Part</b>	<b>GM Part Number</b>	<b>ACDelco Part Number</b>
Passenger Compartment Air Filter	13508023	CF185
Wiper Blades		
Driver Side – 360 mm (14 in)	86816403	—
Center – 360 mm (14 in)	86816403	—
Passenger Side – 360 mm (14 in)	86816403	—

## Maintenance Records

After the scheduled services are performed, record the date, odometer reading, who performed the service, and the type of services performed. Retain all maintenance receipts.



## Technical Data

### Vehicle Identification

Vehicle Identification Number (VIN) ... 364

Service Parts Identification ..... 364

### Vehicle Data

Capacities and Specifications ..... 365

## Vehicle Identification

### Vehicle Identification Number (VIN)



This legal identifier is in the front corner of the instrument panel, on the driver side of the vehicle. It can be seen through the windshield from outside. The Vehicle Identification Number (VIN) also appears on the Vehicle Certification label and certificates of title and registration.

## Service Parts Identification

There may be a large barcode on the certification label on the center pillar that you can scan for the following information:

- Vehicle Identification Number (VIN)
- Model designation
- Paint information
- Production options

If there is not a large barcode on this label, then you will find this same information on a label inside of the glove box.

## Vehicle Data

### Capacities and Specifications

The following capacities are approximate. See your dealer for any capacity not listed.

Refer to *Recommended Fluids and Lubricants* ⇨ 361 for more information.

Application	Capacities	
	Metric	English
Air Conditioning Refrigerant	For the air conditioning system refrigerant charge type and amount, see the refrigerant label under the hood. See your dealer for more information.	
Total Cooling System*	See your dealer.	
Wheel Nut Torque	190 N•m	140 lb ft
*The refilling or adding coolant procedures can be complex. See your dealer.		

## Customer Information

### Customer Information

Customer Satisfaction Procedure .....	366
Customer Assistance Offices .....	368
Customer Assistance for Text Telephone (TTY) Users .....	368
Online Account .....	368
GM Mobility Reimbursement Program .....	369
Roadside Assistance Program .....	369
Scheduling Service Appointments .....	370
Courtesy Transportation Program .....	371
Collision Damage Repair .....	372
Publication Ordering Information .....	373
Radio Frequency Statement .....	374

### Reporting Safety Defects

Reporting Safety Defects to the United States Government .....	374
Reporting Safety Defects to the Canadian Government .....	375
Reporting Safety Defects to General Motors .....	375

### Vehicle Data Recording and Privacy

Vehicle Data Recording and Privacy .....	375
Cybersecurity .....	375
Event Data Recorders .....	376
OnStar .....	376
Infotainment System .....	377

## Customer Information

### Customer Satisfaction Procedure

Your satisfaction and goodwill are important to your dealer and to GMC. Normally, any concerns with the sales transaction or the operation of the vehicle will be resolved by your dealer's sales or service departments. Sometimes, however, despite the best intentions of all concerned, misunderstandings can occur. If your concern has not been resolved to your satisfaction, the following steps should be taken:

**STEP ONE :** Discuss your concern with a member of dealership management. Normally, concerns can be quickly resolved at that level. If the matter has already been reviewed with the sales, service, or parts manager, contact the owner of your dealership or the general manager.

**STEP TWO :** If after contacting a member of dealership management, it appears your concern cannot be resolved by your dealership without further help, in the U.S., call 1-800-462-8782. In Canada, call General Motors of Canada Customer Care Centre at 1-800-263-3777 (English), or 1-800-263-7854 (French).

We encourage you to call the toll-free number in order to give your inquiry prompt attention. Have the following information available to give the Customer Assistance representative:

- Vehicle Identification Number (VIN). This is available from the vehicle registration or title, or the plate at the top left of the instrument panel and visible through the windshield.
- Dealership name and location.
- Vehicle delivery date and present mileage.

When contacting GMC, remember that your concern will likely be resolved at a dealer's facility. That is why we suggest following Step One first.

**STEP THREE — U.S. Owners :** Both General Motors and your dealer are committed to making sure you are completely satisfied with your new vehicle. However, if you continue to remain unsatisfied after following the procedure outlined in Steps One and Two, you can file with the Better Business Bureau (BBB) AUTO LINE Program to enforce your rights.

The BBB AUTO LINE Program is an out-of-court program administered by the BBB National Programs, Inc. to settle

automotive disputes regarding vehicle repairs or the interpretation of the New Vehicle Limited Warranty. Although you may be required to resort to this informal dispute resolution program prior to filing a court action, use of the program is free of charge and your case will generally be heard within 40 days. If you do not agree with the decision given in your case, you may reject it and proceed with any other venue for relief available to you.

You may contact the BBB AUTO LINE Program using the toll-free telephone number or write them at the following address:

BBB Auto Line a Division of  
BBB National Programs, Inc.  
1676 International Drive  
Suite 550  
McLean, VA 22102

Telephone: 1-800-955-5100  
[www.bbbautoine.org](http://www.bbbautoine.org)

This program is available in all 50 states and the District of Columbia. Eligibility is limited by vehicle age, mileage, and other factors. General Motors reserves the right to change eligibility limitations and/or discontinue its participation in this program.

**STEP THREE — Canadian Owners :** In the event that you do not feel your concerns have been addressed after following the procedure outlined in Steps One and Two, General Motors of Canada Company wants you to be aware of its participation in a no-charge Mediation/Arbitration Program. General Motors of Canada Company has committed to binding arbitration of owner disputes involving factory-related vehicle service claims. The program provides for the review of the facts involved by an impartial third party arbiter, and may include an informal hearing before the arbiter. The program is designed so that the entire dispute settlement process, from the time you file your complaint to the final decision, should be completed in about 70 days. We believe our impartial program offers advantages over courts in most jurisdictions because it is informal, quick, and free of charge.

For further information concerning eligibility in the Canadian Motor Vehicle Arbitration Plan (CAMVAP), call toll-free 1-800-207-0685, or call the General Motors Customer Care Centre, 1-800-263-3777 (English), 1-800-263-7854 (French), or write to:

Mediation/Arbitration Program  
c/o Customer Care Centre  
General Motors of Canada Company  
500 Wentworth Street W  
Oshawa, ON L1J 0C5

Your inquiry should be accompanied by the Vehicle Identification Number (VIN).

### **Customer Assistance Offices**

GMC is committed to assisting customers. Visit us online at [www.gmc.com/support](http://www.gmc.com/support) (U.S.) or [www.mygmc.ca](http://www.mygmc.ca) (Canada) to chat with us or find answers to commonly asked questions, tips, vehicle how-to instructions, and available support.

Need more help? Use the phone numbers or mailing addresses below for additional assistance.

#### **United States and Puerto Rico**

GMC Customer Assistance Center  
P.O. Box 33172  
Detroit, MI 48232-5172

1-800-GMC-8782 (1-800-462-8782)  
TTY: Dial 711 relay service and contact  
1-800-833-2438  
Roadside Assistance: 1-888-881-3302

#### **Canada**

Customer Care Centre  
General Motors of Canada Company  
500 Wentworth Street W  
Oshawa, ON L1J 0C5

1-800-263-3777 (English)  
1-800-263-7854 (French)  
1-800-263-3830 (For Text Telephone Devices (TTYs))  
Roadside Assistance: 1-800-268-6800

#### **Overseas**

Please contact the local General Motors Business Unit.

### **Customer Assistance for Text Telephone (TTY) Users**







To assist customers who are deaf, hard of hearing, or speech-impaired and/or who use Text Telephones (TTYs), GMC is able to assist. Please dial the national 711 relay service and contact 1-800-833-2438. TTY users in Canada can dial 1-800-263-3830.

### **Online Account**

#### **Create a GMC Account (U.S.) at [gmc.com](http://gmc.com)**

Learn more about your vehicle features, shop for and manage your connected services and OnStar plans, and access diagnostic information specific to your vehicle.

#### **Membership Benefits**

-  : Download owner's manuals and view vehicle-specific how-to videos.
-  : View maintenance schedules, alerts, and Vehicle Diagnostic Information. Schedule service appointments.
-  : View service records from your dealership and add your own.
-  : Select a dealer and view locations, maps, phone numbers, and hours.
-  : Track your vehicle's warranty information.
-  : View active recalls by Vehicle Identification Number (VIN). See *Vehicle Identification Number (VIN)* ⇨ 364.

 : Manage your profile and payment information. View your GM Rewards Card earnings and My GMC Rewards points.

 : Chat live with online help representatives.

Visit [gmc.com](http://gmc.com) and create an account today.

### **GMC Owner Centre (Canada)** **[mygmccanada.ca](http://mygmccanada.ca)**

Visit the GMC Owner Centre at [mygmccanada.ca](http://mygmccanada.ca) (English) or [my.gmccanada.ca](http://my.gmccanada.ca) (French) to access similar benefits to the U.S. site.

### **GM Mobility Reimbursement Program**

GENERAL MOTORS MOBILITY



This program is available to qualified applicants for cost reimbursement, up to certain limits, of eligible aftermarket

adaptive equipment required for the vehicle, such as hand controls or a wheelchair/scooter lift for the vehicle.

To learn about the GM Mobility program, see [www.gmmobility.com](http://www.gmmobility.com) or call the GM Mobility Assistance Center at 1-800-323-9935. Text Telephone (TTY) users, please dial the national 711 relay service and contact 1-800-323-9935.

General Motors of Canada also has a Mobility program. See [www.gm.ca](http://www.gm.ca), or call 1-800-GM-DRIVE (800-463-7483) for details. TTY users call 1-800-263-3830.

### **Roadside Assistance Program**

For U.S.-purchased vehicles, call 1-888-881-3302; (Text Telephone (TTY): 1-888-889-2438).

For Canadian-purchased vehicles, call 1-800-268-6800.

Service is available 24 hours a day, 365 days a year.

### **Calling for Assistance**

When calling Roadside Assistance, have the following information ready:

- Your name, home address, and home telephone number

- Telephone number of your location
- Location of the vehicle
- Model, year, color, and license plate number of the vehicle
- Odometer reading and Vehicle Identification Number (VIN)
- Description of the problem

### **Coverage**

Tow services are covered under the EV Component Coverage warranty. For details on additional Roadside coverage, contact GMC Roadside Assistance.

In the U.S., anyone driving the vehicle is covered. In Canada, a person driving the vehicle without permission from the owner is not covered.

Roadside Assistance is not a part of the New Vehicle Limited Warranty. General Motors North America and GMC reserve the right to make any changes or discontinue the Roadside Assistance program at any time without notification.

General Motors North America and GMC reserve the right to limit services or payment to an owner or driver if they decide the claims are made too often, or the same type of claim is made many times.

### Services Provided

- **Lock-Out Service:** Service to unlock the vehicle if you are locked out. A remote unlock may be available if you have OnStar. For security reasons, the driver must present identification before this service is given.
- **Tow from a Public Road or Highway:** Tow to the nearest certified GMC EV dealer for warranty service, or if the vehicle was in a crash and cannot be driven. Assistance is not given when the vehicle is stuck in the sand, mud, or snow. If the vehicle is out of charge, Roadside will tow the vehicle to the nearest charging station or to the customer's home, whichever is closest.
- **Flat Tire Change:** Service to change a flat tire with the spare tire. The spare tire, if equipped, must be in good condition and properly inflated. It is the owner's responsibility for the repair or replacement of the tire if it is not covered by the warranty.
- **Battery Jump Start:** Service to jump start a dead battery.
- **Trip Interruption Benefits and Assistance:** If your trip is interrupted due to a warranty event, incidental expenses may

be reimbursed. Items considered are reasonable and customary hotel, meals, rental car, or a vehicle being delivered back to the customer, up to 500 miles. Contact GMC Roadside Assistance for Trip Interruption eligibility at the time of vehicle disablement.

### Services Not Included in Roadside Assistance

- Impound towing caused by violation of any laws
- Legal fines
- Mounting, dismounting, or changing of snow tires, chains, or other traction devices

Service is not provided if a vehicle is in an area that is not accessible to the service vehicle or is not a regularly traveled or maintained public road, which includes ice and winter roads. Off-road use is not covered.

### Services Specific to Canadian-Purchased Vehicles

- **Lock-Out Service:** Vehicle registration is required.

- **Trip Interruption Benefits and Assistance:**

Must be over 150 km from where your trip was started to qualify. Pre-authorization, original detailed receipts, and a copy of the repair orders are required. Once authorization has been received, the Roadside Assistance advisor will help to make arrangements and explain how to receive payment.

- **Alternative Service:** If assistance cannot be provided right away, the Roadside Assistance advisor may give permission to get local emergency road service. You will receive payment, up to \$100, after sending the original receipt to Roadside Assistance. Mechanical failures may be covered, however any cost for parts and labor for repairs not covered by the warranty are the owner's responsibility.

### Scheduling Service Appointments

When the vehicle requires warranty service, contact your dealer and request an appointment. By scheduling a service appointment and advising the service consultant of your transportation needs, your dealer can help minimize your inconvenience.

If the vehicle cannot be scheduled into the service department immediately, keep driving it until it can be scheduled for service, unless, of course, the problem is safety related. If it is, please call your dealership, let them know this, and ask for instructions.

If your dealer requests you to bring the vehicle for service, you are urged to do so as early in the work day as possible to allow for same-day repair.

## Courtesy Transportation Program

To enhance your ownership experience, we and our participating dealers are proud to offer Courtesy Transportation, a customer support program for vehicles with the Bumper-to-Bumper (Base Warranty Coverage period in Canada), Federal Emission, Extended Powertrain or Electric specific warranties in both the U.S. and Canada.

Several Courtesy Transportation options are available to assist in reducing inconvenience when warranty repairs are required.

Courtesy Transportation is not a part of the New Vehicle Limited Warranty. A separate manual entitled "Limited Warranty and

Owner Assistance Information" produced for new vehicles provides detailed warranty coverage information.

### Transportation Options

Warranty service can generally be completed while you wait. However, if you are unable to do so, your dealer may offer the following transportation options:

#### Shuttle Service

This includes one-way or round-trip shuttle service within reasonable time and distance parameters of your dealer's area.

#### Public Transportation or Fuel Reimbursement

If overnight warranty repairs are needed, and public transportation is used, the expense must be supported by original receipts and within the maximum amount allowed by GM. If U.S. customers arrange their own transportation, limited reimbursement for reasonable fuel expenses may be available. Claim amounts should reflect actual costs and be supported by original receipts. See your dealer for information.

### Courtesy Rental Vehicle

For an overnight warranty repair, the dealer may provide an available courtesy rental vehicle or provide for reimbursement of a rental vehicle. Reimbursement is limited and must be supported by original receipts as well as a signed and completed rental agreement and meet state/provincial, local, and rental vehicle provider requirements. Requirements vary and may include minimum age requirements, insurance coverage, credit card, etc. Additional fees such as fuel, rental vehicle insurance, taxes, levies, usage fees, excessive mileage, or rental usage beyond the completion of the repair are also your responsibility.

It may not be possible to provide a like vehicle as a courtesy rental.

### Additional Program Information

All program options, such as shuttle service, may not be available at every dealer. Contact your dealer for specific availability.

General Motors reserves the right to unilaterally modify, change, or discontinue Courtesy Transportation at any time and to resolve all questions of claim eligibility pursuant to the terms and conditions described herein at its sole discretion.



## Collision Damage Repair

If the vehicle is involved in a collision and it is damaged, have the damage repaired by a qualified technician using the proper equipment and quality replacement parts. Poorly performed collision repairs diminish the vehicle resale value, and safety performance can be compromised in subsequent collisions.

### Collision Parts

Genuine GM Collision parts are new parts made with the same materials and construction methods as the parts with which the vehicle was originally built. Genuine GM Collision parts are the best choice to ensure that the vehicle's designed appearance, durability, and safety are preserved. The use of Genuine GM parts can help maintain the GM New Vehicle Limited Warranty.

Recycled original equipment parts may also be used for repair. These parts are typically removed from vehicles that were total losses in prior crashes. In most cases, the parts being recycled are from undamaged sections of the vehicle. A recycled original equipment GM part may be an acceptable choice to maintain the vehicle's originally designed

appearance and safety performance; however, the history of these parts is not known. Such parts are not covered by the GM New Vehicle Limited Warranty, and any related failures are not covered by that warranty.

Aftermarket collision parts are also available. These are made by companies other than GM and may not have been tested for the vehicle. As a result, these parts may fit poorly, exhibit premature durability/corrosion problems, and may not perform properly in subsequent collisions. Aftermarket parts are not covered by the GM New Vehicle Limited Warranty, and any vehicle failure related to such parts is not covered by that warranty.

### Repair Facility

GM also recommends that you choose a collision repair facility that meets your needs before you ever need collision repairs. Your dealer may have a collision repair center with GM-trained technicians and state-of-the-art equipment, or be able to recommend a collision repair center that has GM-trained technicians and comparable equipment.

## Insuring the Vehicle

Protect your investment in the GM vehicle with comprehensive and collision insurance coverage. There are significant differences in the quality of coverage afforded by various insurance policy terms. Many insurance policies provide reduced protection to the GM vehicle by limiting compensation for damage repairs by using aftermarket collision parts. Some insurance companies will not specify aftermarket collision parts. When purchasing insurance, we recommend that you ensure that the vehicle will be repaired with GM original equipment collision parts. If such insurance coverage is not available from your current insurance carrier, consider switching to another insurance carrier.

If the vehicle is leased, the leasing company may require you to have insurance that ensures repairs with Genuine GM Original Equipment Manufacturer (OEM) parts or Genuine Manufacturer replacement parts. Read the lease carefully, as you may be charged at the end of the lease for poor quality repairs.

## If a Crash Occurs

If there has been an injury, call emergency services for help. Do not leave the scene of a crash until all matters have been taken care of. Move the vehicle only if its position puts you in danger, or you are instructed to move it by a police officer.

Give only the necessary information to police and other parties involved in the crash.

For emergency towing see *Roadside Assistance Program* ⇨ 369.

Gather the following information:

- Driver name, address, and telephone number
- Driver license number
- Owner name, address, and telephone number
- Vehicle license plate number
- Vehicle make, model, and model year
- Vehicle Identification Number (VIN)
- Insurance company and policy number
- General description of the damage to the other vehicle

Choose a reputable repair facility that uses quality replacement parts. See “Collision Parts” earlier in this section.

In a crash, the sensing system may shut down the high voltage system. See *Battery - North America* ⇨ 299 for important safety information. If an airbag has inflated, see *What Will You See after an Airbag Inflates?* ⇨ 56.

If the vehicle is damaged from a crash, flood, fire, or other event it may be necessary to have the vehicle inspected. See *Battery - North America* ⇨ 299 for important safety information.

## Managing the Vehicle Damage Repair Process

In the event that the vehicle requires damage repairs, GM recommends that you take an active role in its repair. If you have a pre-determined repair facility of choice, take the vehicle there, or have it towed there. Specify to the facility that any required replacement collision parts be original equipment parts, either new Genuine GM parts or recycled original GM parts. Remember, recycled parts will not be covered by the GM vehicle warranty.

Insurance pays the bill for the repair, but you must live with the repair. Depending on your policy limits, your insurance company may initially value the repair using aftermarket parts. Discuss this with the repair professional, and insist on Genuine GM parts. Remember, if the vehicle is leased, you may be obligated to have the vehicle repaired with Genuine GM parts, even if your insurance coverage does not pay the full cost.

If another party's insurance company is paying for the repairs, you are not obligated to accept a repair valuation based on that insurance company's collision policy repair limits, as you have no contractual limits with that company. In such cases, you can have control of the repair and parts choices as long as the cost stays within reasonable limits.

## Publication Ordering Information

### Service Manuals

Service manuals have the diagnosis and repair information on the engine/propulsion, transmission, axle, suspension, brakes, electrical system, steering system, body, etc.

**Customer Literature**

Owner's manuals are written specifically for owners and are intended to provide basic operational information about the vehicle. The owner's manual includes the Maintenance Schedule for all models.

Customer literature publications available for purchase include owner's manuals, warranty manuals, and portfolios. Portfolios include an owner's manual, warranty manual, if applicable, and zip lock bag or pouch.

**Current and Past Models**

Service manuals and customer literature are available for many current and past model year GM vehicles.

To order, call 1-800-551-4123 Monday–Friday, 8:00 a.m.–6:00 p.m. Eastern Time

For credit card orders only (VISA, MasterCard, or Discover), see Helm, Inc. at: [www.helminc.com](http://www.helminc.com).

To order by mail, write to:

Helm, Incorporated  
Attention: Customer Service  
47911 Halyard Drive  
Plymouth, MI 48170

Make checks payable in U.S. funds.

**Radio Frequency Statement**

This vehicle uses license-exempt transmitters / receivers / systems that operate on a radio frequency that complies with Part 15/ Part 18 of the Federal Communications Commission (FCC) rules and with Innovation, Science and Economic Development (ISED) Canada's license-exempt RSS(s) / RSP-100 / ICES-GEN.

Operation is subject to the following two conditions:

1. The device may not cause harmful interference.
2. The device must accept any interference received, including interference that may cause undesired operation of the device.

Changes or modifications to any of these systems by other than an authorized service facility could void authorization to use this equipment.

**Reporting Safety Defects****Reporting Safety Defects to the United States Government**

If you believe that your vehicle has a defect which could cause a crash or could cause injury or death, you should immediately inform the National Highway Traffic Safety Administration (NHTSA) in addition to notifying General Motors.

If NHTSA receives similar complaints, it may open an investigation, and if it finds that a safety defect exists in a group of vehicles, it may order a recall and remedy campaign. However, NHTSA cannot become involved in individual problems between you, your dealer, or General Motors.

To contact NHTSA, you may call the Vehicle Safety Hotline toll-free at 1-888-327-4236 (TTY: 1-800-424-9153); go to <https://www.safercar.gov>; or write to:

Administrator, NHTSA  
1200 New Jersey Avenue, S.E.  
Washington, D.C. 20590

You can also obtain other information about motor vehicle safety from <https://www.safercar.gov>.

## Reporting Safety Defects to the Canadian Government

If you live in Canada, and you believe that the vehicle has a safety defect, notify Transport Canada immediately, and notify General Motors of Canada Company. Call Transport Canada at 1-800-333-0510; go to:

[www.tc.gc.ca/recalls](http://www.tc.gc.ca/recalls) (English)

[www.tc.gc.ca/rappels](http://www.tc.gc.ca/rappels) (French)

or write to:

Transport Canada  
Motor Vehicle Safety Directorate  
Defect Investigations and Recalls  
Division  
80 Noel Street  
Gatineau, QC J8Z 0A1

## Reporting Safety Defects to General Motors

In addition to notifying NHTSA (or Transport Canada) in a situation like this, notify General Motors.

In the U.S., call 1-800-462-8782, or write:

GMC Customer Assistance Center  
P.O. Box 33172  
Detroit, MI 48232-5172

In Canada, call 1-800-263-3777 (English) or 1-800-263-7854 (French), or write:

Customer Care Centre  
General Motors of Canada Company  
500 Wentworth Street W  
Oshawa, ON L1J 0C5

In Mexico, call 800-466-0812 or 800-466-0801.

In other Central America and Caribbean Countries, call 52-555-901-2369.

## Vehicle Data Recording and Privacy

The vehicle has a number of computers that record information about the vehicle's performance and how it is driven or used.

For example, the vehicle uses computer modules to monitor and control electric drive unit performance, to monitor the conditions for airbag deployment and to deploy them in a crash, and, if equipped, to provide antilock braking to help the driver control the vehicle. These modules may store data to help the dealer technician service the vehicle or to help GM improve safety or features. Some modules may also store data about how the vehicle is operated, such as rate of energy consumption or average speed. These modules may retain personal preferences, such as radio presets, seat positions, and temperature settings.

## Cybersecurity

GM collects information about the use of your vehicle including operational and safety related information. We collect this information to provide, evaluate, improve, and troubleshoot our products and services and to develop new products and services. The protection of vehicle electronics systems and customer data from unauthorized outside electronic access or control is important to GM. GM maintains appropriate security standards, practices, guidelines and controls aimed at defending the vehicle and

the vehicle service ecosystem against unauthorized electronic access, detecting possible malicious activity in related networks, and responding to suspected cybersecurity incidents in a timely, coordinated and effective manner. Security incidents could impact your safety or compromise your private data. To minimize security risks, please do not connect your vehicle electronic systems to unauthorized devices or connect your vehicle to any unknown or untrusted networks (such as Bluetooth, WIFI or similar technology). In the event you suspect any security incident impacting your data or the safe operation of your vehicle, please stop operating your vehicle and contact your dealer.

## Event Data Recorders

This vehicle is equipped with an Event Data Recorder (EDR). The main purpose of an EDR is to record, in certain crash or near crash-like situations, such as an air bag deployment or hitting a road obstacle, data that will assist in understanding how a vehicle's systems performed. The EDR is designed to record data related to vehicle dynamics and safety systems for a short

period of time, typically 30 seconds or less. The EDR in this vehicle is designed to record such data as:

- How various systems in your vehicle were operating;
- Whether or not the driver and passenger safety belts were buckled/fastened;
- How far (if at all) the driver was depressing the accelerator and/or brake pedal; and,
- How fast the vehicle was traveling.

These data can help provide a better understanding of the circumstances in which crashes and injuries occur.

### Note

EDR data are recorded by your vehicle only if a non-trivial crash situation occurs; no data are recorded by the EDR under normal driving conditions and no personal data (e.g., name, gender, age, and crash location) are recorded. However, other parties, such as law enforcement, could combine the EDR data with the type of personally identifying data routinely acquired during a crash investigation.

To read data recorded by an EDR, special equipment is required, and access to the vehicle or the EDR is needed. In addition to

the vehicle manufacturer, other parties, such as law enforcement, that have the special equipment, can read the information if they have access to the vehicle or the EDR.

GM will not access these data or share it with others except: with the consent of the vehicle owner or, if the vehicle is leased, with the consent of the lessee; in response to an official request by police or similar government office; as part of GM's defense of litigation through the discovery process; or, as permitted by law. Data that GM collects or receives may also be used for GM research needs or may be made available to others for research purposes, where a need is shown and the data is not tied to a specific vehicle or vehicle owner.

## OnStar

If the vehicle is equipped with OnStar and has an active service plan, additional data may be collected and transmitted through the OnStar system. This includes information about the vehicle's operation; collisions involving the vehicle; the use of the vehicle and its features, including infotainment; and the location and approximate GPS speed of the vehicle. Refer to the OnStar Terms and Conditions and Privacy Statement on the OnStar website.

See *OnStar Additional Information* ⇨ 380.

## **Infotainment System**

If the vehicle is equipped with a navigation system as part of the infotainment system, use of the system may result in the storage of destinations, addresses, telephone numbers, and other trip information. See the infotainment section for information on stored data and for deletion instructions.

## OnStar

### OnStar Overview

OnStar Overview ..... 378

### OnStar Services

Emergency ..... 379

Security ..... 379

### OnStar Additional Information

OnStar Additional Information ..... 380

## OnStar Overview



 Voice Command Button

 Blue OnStar Button

 Red Emergency Button

This vehicle may be equipped with a comprehensive, in-vehicle system that can connect to an OnStar Advisor for Emergency, Security, Navigation, Connections, and Diagnostics Services. OnStar services may require a paid service plan and data plan. OnStar requires the vehicle battery and electrical system, cellular service, and GPS satellite signals to be available and operating. OnStar acts as a link to existing emergency service providers. OnStar may collect information about you and your vehicle, including location information. See OnStar User Terms, Privacy Statement, and Software Terms for more details including system limitations at [www.onstar.com](http://www.onstar.com) (U.S.) or [www.onstar.ca](http://www.onstar.ca) (Canada).

The OnStar system status light is next to the OnStar buttons. If the status light is:

- Solid Green: System is ready.
- Flashing Green: On a call.
- Red: Indicates a problem.
- Off: System is off. Press  twice to speak with an OnStar Advisor.

Press  or call 1-888-4ONSTAR (1-888-466-7827) to speak to an Advisor.

Functionality of the Voice Command button may vary by vehicle and region.

Press  to:

- Open the OnStar app on the infotainment display. If equipped, the infotainment system has OnStar controls in the embedded OnStar app on the Home Page. Most OnStar functions that can be performed with the buttons can be done using the app. To open the app, touch the OnStar icon on the Home Page. App updates require a corresponding service plan. Features vary by region and model. Features are subject to change. For more information, see [my.gmc.com/learn](http://my.gmc.com/learn) or press .

Or

- Give OnStar Turn-by-Turn Navigation voice commands.
- Obtain and customize the Wi-Fi hotspot name or SSID and password, if equipped.

Press **OR** to connect to an Advisor to:

- Verify account information or update contact information.
- Get driving directions.
- Receive a Diagnostic check of the vehicle's key operating systems.
- Receive Roadside Assistance.
- Manage Wi-Fi Settings, if equipped.

Press **SOS** to get a priority connection to an OnStar Advisor available 24/7 to:

- Get help for an emergency.
- Be a Good Samaritan or respond to an AMBER Alert.
- Get assistance in severe weather or other crisis situations and find evacuation routes.

## OnStar Services

### Emergency

Emergency Services require an active safety and security plan. With Automatic Crash Response, built-in sensors can automatically alert a specially trained OnStar Advisor who is immediately connected in to the vehicle to help.

Press **SOS** for a priority connection to an OnStar Advisor who can contact emergency service providers, direct them to your exact location, and relay important information.

With OnStar Crisis Assist, specially trained Advisors are available 24 hours a day, 7 days a week, to provide a central point of contact, assistance, and information during a crisis.

With Roadside Assistance, Advisors can locate a nearby service provider to help with a flat tire or a battery jump.

### Security

If equipped, OnStar provides these services:

- With Stolen Vehicle Assistance, OnStar Advisors can use GPS to pinpoint the vehicle and help authorities quickly recover it.
- With Remote Ignition Block, if equipped, OnStar can block the vehicle from being restarted.
- With Stolen Vehicle Slowdown, if equipped, OnStar can work with law enforcement to gradually slow the vehicle down.

### Theft Alarm Notification

If equipped, if the doors are locked and the vehicle alarm sounds, a notification by text, e-mail, or phone call will be sent. If the vehicle is stolen, an OnStar Advisor can work with authorities to recover the vehicle.



## OnStar Additional Information

### In-Vehicle Audio Messages

Audio messages may play important information at the following times:

- Prior to vehicle purchase. Press **On** to set up an account.
- After change in ownership and at 90 days.

### Transferring Service

Press **On** to request account transfer eligibility information. The Advisor can cancel or change account information.

### Selling/Transferring the Vehicle

Call 1-888-4ONSTAR (1-888-466-7827) immediately to terminate your OnStar or connected services if the vehicle is disposed of, sold, transferred, or if the lease ends.

### Reactivation for Subsequent Owners

Press **On** and follow the prompts to speak to an Advisor as soon as possible. The Advisor will update vehicle records and explain OnStar or connected service options.

### How OnStar Service Works

Automatic Crash Response, Emergency Services, Crisis Assist, Stolen Vehicle Assistance, Remote Services, and Roadside Assistance are available on most vehicles. Not all OnStar services are available everywhere or on all vehicles. For more information, a full description of OnStar services, system limitations, and OnStar User Terms, Privacy Statement, and Software Terms:

- Call 1-888-4ONSTAR (1-888-466-7827).
- See [www.onstar.com](http://www.onstar.com) (U.S.).
- See [www.onstar.ca](http://www.onstar.ca) (Canada).
- Call TTY 1-877-248-2080.
- Press **On** to speak with an Advisor.

OnStar or connected services cannot work unless the vehicle is in a place where OnStar has an agreement with a wireless service provider for service in that area. The wireless service provider must also have coverage, network capacity, reception, and technology compatible with OnStar or connected services. Service involving location information about the vehicle cannot work unless GPS signals are available, unobstructed, and compatible with the OnStar hardware. OnStar or connected

services may not work if the OnStar equipment is not properly installed or it has not been properly maintained. If equipment or software is added, connected, or modified, OnStar or connected services may not work. Other problems beyond the control of OnStar — such as hills, tall buildings, tunnels, weather, electrical system design and architecture of the vehicle, damage to the vehicle in a crash, or wireless phone network congestion or jamming — may prevent service.

See *Radio Frequency Statement* ⇨ 374.

### Services for People with Disabilities

Advisors provide services to help with physical disabilities and medical conditions.

Press **On** to help:

- Find a hotel, restaurant, etc., that meets accessibility needs.
- Provide directions to the closest hospital or pharmacy in urgent situations.

### TTY Users

OnStar has the ability to communicate to deaf, hard-of-hearing, or speech-impaired customers while in the vehicle. The available

TTY system can provide in-vehicle access to all OnStar services, except Virtual Advisor and OnStar Turn-by-Turn Navigation.

If equipped, TTY mode can be turned on or off by touching Settings, then Apps, and then Phone. When TTY mode is on, phone calls can be made or received with OnStar using the infotainment display.

### OnStar Personal Identification Number (PIN)

A PIN is needed to access some OnStar services. The PIN will need to be changed the first time when speaking with an Advisor. To change the OnStar PIN, contact an OnStar Advisor by pressing  or calling 1-888-4ONSTAR.

### Warranty

OnStar equipment may be warranted as part of the vehicle warranty.

### Languages

The vehicle can be programmed to respond in multiple languages. Press  and ask for an Advisor. Advisors are available in English, Spanish, and French. Available languages may vary by country.

### Potential Issues

OnStar cannot perform Remote Door Unlock or Stolen Vehicle Assistance after the vehicle has been off continuously for an extended period of time without being started. To find out the duration of time that applies for the vehicle, contact an OnStar Advisor by pressing  or calling 1-888-4ONSTAR. If the vehicle has not been started for an extended period of time, OnStar can contact Roadside Assistance or a locksmith to help gain access to the vehicle.

### Global Positioning System (GPS)

- Obstruction of the GPS can occur in a large city with tall buildings; in parking garages; around airports; in tunnels and underpasses; or in an area with very dense trees. If GPS signals are not available, the OnStar system should still operate to call OnStar. However, OnStar could have difficulty identifying the exact location.
- In emergency situations, OnStar can use the last stored GPS location to send to emergency responders.

A temporary loss of GPS can cause loss of the ability to send a Turn-by-Turn Navigation route. The Advisor may give a verbal route or may ask for a call back after the vehicle is driven into an open area.

### Cellular and GPS Antennas

Cellular reception is required for OnStar to send remote signals to the vehicle. Do not place items over or near the antenna to prevent blocking cellular and GPS signal reception.

### Unable to Connect to OnStar Message

If there is limited cellular coverage or the cellular network has reached maximum capacity, this message may come on. Press  to try the call again or try again after driving a few miles into another cellular area.

### Vehicle and Power Issues

OnStar services require a vehicle electrical system, wireless service, and GPS satellite technologies to be available and operating for features to function properly. These systems may not operate if the battery is discharged or disconnected.

### Add-on Electrical Equipment

The OnStar system is integrated into the electrical architecture of the vehicle. Do not add any electrical equipment. See *Add-On Electrical Equipment* ⇨ 288. Added electrical equipment may interfere with the operation of the OnStar system and cause it to not operate.

### Vehicle Software Updates

OnStar or GM may remotely deliver software updates or changes to the vehicle without further notice or consent. These updates or changes may enhance or maintain safety, security, or the operation of the vehicle or the vehicle systems. Software updates or changes may affect or erase data or settings that are stored in the vehicle, such as saved navigation destinations or pre-set radio stations. Neither OnStar nor GM is responsible for any affected or erased data or settings. These updates or changes may also collect personal information. Such collection is described in the OnStar privacy statement or separately disclosed at the time of installation. These updates or changes may also cause a system to automatically communicate with GM servers to collect information about vehicle system status,

identify whether updates or changes are available, or deliver updates or changes. An active OnStar agreement constitutes consent to these software updates or changes and agreement that either OnStar or GM may remotely deliver them to the vehicle.

### Privacy

The complete OnStar Privacy Statement may be found at [www.onstar.com](http://www.onstar.com) (U.S.), or [www.onstar.ca](http://www.onstar.ca) (Canada). We recommend that you review it. If you have any questions, call 1-888-4ONSTAR (1-888-466-7827) or press  to speak with an Advisor. Users of wireless communications are cautioned that the privacy of any information sent via wireless cellular communications cannot be assured. Third parties may unlawfully intercept or access transmissions and private communications without consent.

### OnStar - Software Acknowledgements

To obtain the source code under GPL, LGPL, MPL, and other open source licenses, that is contained in this product, please visit <https://opensource.lge.com>. In addition to the source code, all referred license terms, warranty disclaimers, and copyright notices are available for download. This offer is valid

for a period of three years after our last shipment of this product. This offer is valid to anyone in receipt of this information.

\*Provided through LG Electronics Inc., who is solely responsible for provisions of related OSS compliance.

## Connected Services

### Connected Services

Navigation .....	383
Connections .....	383
Diagnostics .....	385

## Connected Services

### Navigation

Navigation requires a specific OnStar or connected service plan.

Press  to receive Turn-by-Turn directions or have them sent to the vehicle's navigation screen, if equipped. Select Turn-by-Turn Directions from the Services tab of the OnStar app to call an Advisor or select a recent or favorite destination. Touch the navigation icons to select home, address, or place. A destination transfer from OnStar will show the detail view of the destination when it is transferred from OnStar to the Navigation application. See [www.onstar.com](http://www.onstar.com) for a coverage map. Services vary by model. Map coverage is available in the United States and Canada.

### Turn-by-Turn Navigation

1. Press  to connect to an Advisor.
2. Request directions to be downloaded to the vehicle.
3. Follow the voice-guided commands.

### Using Voice Commands During a Planned Route

Functionality of the Voice Command button, if equipped, may vary by vehicle and region. For some vehicles, press  to open the OnStar app on the infotainment display.

### Send Destination to Vehicle

Directions can be sent to the vehicle's navigation screen, if equipped.

Press , then ask the Advisor to download directions to the vehicle's navigation system, if equipped. After the call ends, the navigation screen will provide prompts to begin driving directions. Routes that are sent to the navigation screen can only be canceled through the navigation system.

See [www.onstar.com](http://www.onstar.com) (U.S.) or [www.onstar.ca](http://www.onstar.ca) (Canada).

### Connections

The following services help with staying connected.

For coverage maps, see [www.onstar.com](http://www.onstar.com) (U.S.) or [www.onstar.ca](http://www.onstar.ca) (Canada).

**Ensuring Security**

- Change the default passwords for the Wi-Fi hotspot and myGMC mobile application. Make these passwords different from each other and use a combination of letters and numbers to increase the security.
- Change the default name of the SSID (Service Set Identifier). This is your network's name that is visible to other wireless devices. Choose a unique name and avoid family names or vehicle descriptions.

**Wi-Fi Hotspot (If Equipped)**

The vehicle may have a built-in Wi-Fi hotspot that provides access to the Internet and web content at 4G LTE speed. Up to seven mobile devices can be connected. A data plan is required. Use the in-vehicle controls only when it is safe to do so.

1. To retrieve Wi-Fi hotspot information, press  to open the OnStar app on the infotainment display, then select Wi-Fi Hotspot. On some vehicles, touch Wi-Fi or Wi-Fi Settings on the screen.
2. The Wi-Fi settings will display the Wi-Fi hotspot name (SSID), password, and on some vehicles, the connection type (no

Internet connection, 3G, 4G, 4G LTE), and signal quality (poor, good, excellent). The LTE icon shows connection to Wi-Fi. It is possible that the icon may not illuminate even though the vehicle has an active connection.

3. To change the SSID or password, press  or call 1-888-4ONSTAR to connect with an Advisor. On some vehicles, the SSID and password can be changed in the Wi-Fi Hotspot menu.

After initial set-up, your vehicle's Wi-Fi hotspot will connect automatically to your mobile devices. Manage data usage by turning Wi-Fi on or off on your mobile device, using the myGMC mobile app, or by contacting an OnStar Advisor. On some vehicles, Wi-Fi can also be managed from the Wi-Fi Hotspot menu.

**myGMC Mobile App (If Available)**

Download the myGMC mobile app to compatible Apple and Android smartphones. GMC users can access the following services from a smartphone:

- Remotely start/stop the vehicle, if factory-equipped.
- Lock/unlock doors, if equipped with automatic locks.

- Activate the horn and lamps.
- Check the vehicle's energy level, range or tire pressure, if factory-equipped with the Tire Pressure Monitor System.
- Send destinations to the vehicle.
- Locate the vehicle on a map (U.S. market only).
- Turn the vehicle's Wi-Fi hotspot on/off, manage settings, and monitor data consumption, if equipped.
- Locate a dealer and schedule service.
- Request Roadside Assistance.
- Set a parking reminder with pin drop, take a photo, make a note, and set a timer.
- Connect with GMC on social media.

Features are subject to change. For myGMC mobile app information and compatibility, see [my.gmc.com](http://my.gmc.com).

An active OnStar or connected service plan may be required. A compatible device, factory-installed remote start, and power locks are required. Data rates apply. See [www.onstar.com](http://www.onstar.com) for details and system limitations.

**Remote Services**

Contact an OnStar Advisor to unlock the doors or sound the horn and flash the lamps.

**Marketplace**

OnStar Advisors can provide offers from restaurants and retailers on your route, help locate hotels, or book a room. These services vary by market.

**Diagnostics**

By monitoring and reporting on the vehicle's key systems, OnStar Advanced Diagnostics, if equipped, provides a way to keep up on maintenance. Capabilities vary by model. See [www.onstar.com](http://www.onstar.com) for details and system limitations. Features are subject to change. For updates on feature capabilities, see [my.gmc.com](http://my.gmc.com). Message and data rates may apply.

## Index

- A**
- Acceleration Mode ..... 193
  - Accessories and Modifications ..... 291
  - Accessory Power .....182
  - Adaptive
    - Cruise Control ..... 203
  - Add-On Electrical Equipment ..... 288
  - Additional
    - OnStar Information ..... 380
  - Adjustments
    - Lumbar, Front Seats ..... 40
  - Agreements
    - Trademarks and License ..... 153
  - Air
    - Conditioning ..... 156, 158
    - Filter, Passenger Compartment ..... 160
    - Suspension ..... 201
    - Suspension Light ..... 107
    - Vents ..... 159
  - Airbag System .....53
    - Check ..... 62
    - How Does an Airbag Restrain? ..... 56
    - Passenger Sensing System ..... 57
    - What Makes an Airbag Inflate? ..... 56
    - What Will You See after an Airbag
      - Inflates? ..... 56
    - When Should an Airbag Inflate? ..... 55
    - Where Are the Airbags? ..... 54
  - Airbags
    - Adding Equipment to the Vehicle ..... 61
    - Passenger Status Indicator ..... 101
    - Readiness Light ..... 100
    - Replacing System Parts after a
      - Crash ..... 62
    - Servicing Airbag-Equipped Vehicles ..... 61
  - Alarm
    - Vehicle Security ..... 23
  - Alert
    - Lane Change ..... 248
    - Rear Cross Traffic ..... 242
    - Rear Pedestrian ..... 242
    - Side Blind Zone (SBZA) ..... 248
  - All-Terrain Tires .....315
  - AM-FM Radio .....134
  - Antenna
    - Multi-band ..... 136
  - Antilock Brake System (ABS) ..... 188
    - Warning Light ..... 103
  - Appearance Care
    - Exterior ..... 349
    - Interior ..... 354
  - Apple CarPlay and Android Auto .....147
  - Apps
    - Off-Road ..... 170
  - Assistance Program, Roadside ..... 369

Assistance Systems		Bluetooth		Camera	
Driving	243	Audio	137	Rear Vision (RVC)	229
Parking and Backing	228	Overview	142, 143	Canadian Vehicle Owners	2
Audio		Brake		Capacities and Specifications	365
Bluetooth	137	Fluid	298	Car Wash Mode	184
Automatic		System Warning Light	102	Carbon Monoxide	
Dimming Mirrors	26	Brakes	297	Tailgate	19
Door Locks	15	Antilock	188	Winter Driving	174
Emergency Braking (AEB)	245	Brake Assist	190	Cargo	
Emergency Braking (AEB) Disabled		Electric Parking Brake	189	Tie-Downs	84
Light	104	Regenerative Braking	190	Caution, Danger, and Warning	2
Headlamp System	124	Braking	164	Center Console	
Parking Assist (APA)	238	Automatic Emergency (AEB)	245	Storage	84
Avoiding Untrusted Media Devices	136	Reverse Automatic	240	Chains, Tire	332
Axle		Braking System		Charge	
Locking Front	200	Front Pedestrian (FPB)	246	Cord	259
<b>B</b>		Break-In, New Vehicle	180	Charge Cord Connected Light	102
Battery		Buckle To Drive	47	Charging	109
Charging Electrical Requirements	262	Bulb Replacement		Delay Override	257
Exterior Lighting Battery Saver	128	Headlamp Aiming	303	Plug-In	253
Fault Light	102	Buying New Tires	328	Status Feedback	257
Gauge	98	<b>C</b>		System Light	101
Load Management	128	California		Utility Interruption	261
Power Protection	128	Perchlorate Materials Requirements	291	Wireless	91
Battery - North America	299, 344	California Proposition 65 Warning	1, 344	Child Restraints	
Blade Replacement, Wiper	302			Infants and Young Children	64
				Lower Anchors and Tethers for Children	69



Child Restraints (cont'd)			
Older Children .....	62		
Securing .....	77, 79		
Systems .....	66		
Child Safety Locks .....	15		
Circuit Breakers .....	305		
Cleaning			
Exterior Care .....	349		
Interior Care .....	354		
Climate Control Systems			
Dual Automatic .....	156		
Rear .....	158		
Clock .....	89		
Cluster, Instrument .....	94		
Collision Damage Repair .....	372		
Compartment			
Underhood .....	295		
Compartments			
Storage .....	82		
Compressor Kit, Tire Sealant .....	333		
Connected Services			
Connections .....	383		
Diagnostics .....	385		
Navigation .....	383		
Connections			
Connected Services .....	383		
Control			
Traction and Electronic Stability .....	191		
Control of a Vehicle .....	164		
Controls			
Steering Wheel .....	130		
Cooling .....	156, 158		
Cooling System .....	296		
Courtesy Transportation Program .....	371		
Cruise Control			
Adaptive .....	203		
Light .....	109		
Super .....	213		
Cupholders .....	82		
Customer Assistance			
Offices .....	368		
Text Telephone (TTY) Users .....	368		
Customer Information			
Publications Ordering Information .....	373		
Customer Satisfaction Procedure .....	366		
Cybersecurity .....	375		
<b>D</b>			
Damage Repair, Collision .....	372		
Danger, Warning, and Caution .....	2		
Dashboard .....	4		
Data Collection			
Infotainment System .....	377		
OnStar .....	376		
Data Recorders, Event .....	376		
Daytime Running Lamps (DRL) .....	124		
Defensive Driving .....	164		
Delayed Charging Override .....	257		
Delayed Locking .....	14		
Destination .....	139		
Diagnostics			
Connected Services .....	385		
Digital			
Key .....	16		
Disabled Vehicle			
Transporting .....	347		
Distracted Driving .....	163		
Dome Lamps .....	126		
Door			
Ajar Light .....	109		
Delayed Locking .....	14		
Locks .....	13		
Power Locks .....	14		
Drive Unit			
Electric .....	184		
Driver			
Assistance Systems .....	227		
Information Center (DIC) .....	116		
Mode Control .....	194		
Mode Control Light .....	106		
Teen .....	150		
Driving			
Assistance Systems .....	243		
Characteristics and Towing Tips .....	263		

Driving (cont'd)

- Defensive ..... 164
- Distracted ..... 163
- Hill and Mountain Roads ..... 174
- If the Vehicle is Stuck ..... 175
- Impaired ..... 164
- Loss of Control ..... 166
- Off-Road ..... 166
- Off-Road Recovery ..... 165
- One-Pedal ..... 187
- Vehicle Load Limits ..... 176
- Wet Roads ..... 173
- Winter ..... 174

Driving for Better Energy Efficiency ..... 162

Dual

- Automatic Climate Control System .... 156

**E**

Electric

- Drive Unit ..... 184
- Parking Brake ..... 189
- Parking Brake Light ..... 103

Electrical

- Equipment, Add-On ..... 288
- Requirements for Battery Charging .... 262
- System Overload ..... 303

Electrical System

- Fuses and Circuit Breakers ..... 305

Electrical System (cont'd)

- Instrument Panel Fuse Block ..... 310, 312

Emergency

- OnStar ..... 379

Energy Efficiency

- Driving ..... 162

Energy Information .....116

Engine

- Cooling System ..... 296

Entry Lighting .....127

Equipment, Towing ..... 270

Event Data Recorders ..... 376

Exit Lighting .....127

Extended Parking .....183

Extender, Seat Belt .....52

Exterior

- Cargo Lamps ..... 125
- Lamp Controls ..... 122
- Lamps Off Reminder ..... 123
- Lighting Battery Saver ..... 128

**F**

- Flash-to-Pass .....123
- Flashers, Hazard Warning .....125
- Flat Tire ..... 332
- Changing ..... 339
- Floor Mats ..... 357

Fluid

- Brakes ..... 298
- Washer ..... 297

Folding Mirrors .....25

Forward

- Collision Alert (FCA) System ..... 243

Four-Wheel

- Steering Light ..... 106

Four-Wheel Drive ..... 188

Four-Wheel Steering ..... 196

Four-Wheel-Drive

- Light ..... 104

Frequency Statement

- Radio ..... 374

Front

- Heated and Ventilated Seats ..... 43
- Locking Axle ..... 200
- Pedestrian Braking (FPB) System ..... 246

Full-Size Spare Tire ..... 344

Fuses

- Fuses and Circuit Breakers ..... 305
- Instrument Panel Fuse Block ..... 310, 312
- Underhood Compartment ..... 305

**G**

- Garage Door Opener .....119
- Programming ..... 119

Gauges			
Battery .....	98		
Odometer .....	97		
Power Indicator .....	99		
Speedometer .....	97		
Trip Odometer .....	97		
Warning Lights and Indicators .....	94		
General Information			
Service and Maintenance .....	358		
Towing .....	262		
Vehicle Care .....	291		
Global Positioning System (GPS) .....	140		
Glove Box .....	82		
GM Mobility Reimbursement			
Program .....	369		
Guidance			
Problems with the Route .....	140		
<b>H</b>			
Hazard Warning Flashers .....	125		
Head Restraints .....	37		
Headlamps			
Aiming .....	303		
Automatic .....	124		
Daytime Running Lamps (DRL) .....	124		
Flash-to-Pass .....	123		
High-Beam On Light .....	108		
High/Low Beam Changer .....	123		
Headlamps (cont'd)			
Lamps On Reminder .....	108		
Heated			
Mirrors .....	26		
Rear Seats .....	45		
Steering Wheel .....	87		
Ventilated Front Seats .....	43		
Heating .....	156, 158		
High Voltage Battery Gauge .....	98		
High Voltage Devices and Wiring .....	303		
High-Beam On Light .....	108		
Hill and Mountain Roads .....	174		
Hill Start Assist (HSA) .....	190		
Hood .....	16, 292		
Horn .....	87		
How to Wear Seat Belts Properly .....	47		
HVAC .....	156, 158		
<b>I</b>			
Immobilizer .....	24		
Indicator			
Pedestrian Ahead .....	105		
Vehicle Ahead .....	105		
Indicators			
Warning Lights and Gauges .....	94		
Infants and Young Children, Restraints .....	64		
Information			
Energy .....	116		
Information (cont'd)			
Publication Ordering .....	373		
Infotainment			
Using the System .....	131		
Infotainment System .....	377		
Inspection			
Multi-Point Vehicle .....	360		
Instrument Cluster .....	94		
Instrument Panel Overview .....	4		
Interior Rearview Mirrors .....	26		
Introduction .....	2, 129		
<b>J</b>			
Jump			
Starting - North America .....	344		
<b>K</b>			
Keys .....	6		
Digital .....	16		
Remote .....	7		
Remote Operation .....	7		
<b>L</b>			
Labeling, Tire Sidewall .....	315		
Lamps			
Daytime Running (DRL) .....	124		
Dome .....	126		
Exterior Cargo .....	125		
Exterior Controls .....	122		

Lamps (cont'd)		Lights (cont'd)		Lock	
Exterior Lamps Off Reminder .....	123	Automatic Emergency Braking		Steering Column .....	23
Exterior Lighting Battery Saver .....	128	(AEB) Disabled .....	104	Locking Front Axle .....	200
Flash-to-Pass .....	123	Battery Fault .....	102	Locking Rear Axle .....	199
High/Low Beam Changer .....	123	Brake System Warning .....	102	Locks	
On Reminder .....	108	Charge Cord Connected .....	102	Automatic Door .....	15
Reading .....	127	Charging System .....	101	Delayed Locking .....	14
Lane		Cruise Control Light .....	109	Door .....	13
Change Alert (LCA) .....	248	Door Ajar .....	109	Lockout Protection .....	15
Keep Assist (LKA) .....	250	Driver Mode Control .....	106	Power Door .....	14
Keep Assist Light .....	104	Electric Parking Brake .....	103	Safety .....	15
Lap-Shoulder Belt .....	49	Four-Wheel Steering .....	106	Loss of Control .....	166
LATCH System		Four-Wheel-Drive .....	104	Low State of Charge Light .....	102
Replacing Parts after a Crash .....	77	Gauges and Indicators .....	94	Lower Anchors and Tethers for	
LATCH, Lower Anchors and Tethers for		High-Beam On .....	108	Children (LATCH System) .....	69
Children .....	69	Lane Keep Assist .....	104	Lumbar Adjustment .....	40
LED Lighting .....	303	Low State of Charge .....	102	Front Seats .....	40
Lighting		Seat Belt Reminders .....	100	<b>M</b>	
Entry .....	127	Security .....	108	Maintenance	
Exit .....	127	Service Electric Parking Brake .....	103	Records .....	363
Illumination Control .....	126	Service Vehicle Soon .....	102	Maintenance Schedule .....	359
LED .....	303	StabiliTrak OFF .....	105	Recommended Fluids and	
Lights		Tire Pressure .....	107	Lubricants .....	361
Air Suspension .....	107	Traction Control System		Maps .....	138
Airbag Readiness .....	100	(TCS)/StabiliTrak .....	106	Media	
Antilock Brake System (ABS)		Traction Off .....	105	Avoiding Untrusted Devices .....	136
Warning .....	103	Vehicle Ready .....	108	Memory Seats .....	40

- Messages  
   Propulsion Power ..... 118  
   Vehicle ..... 118  
   Vehicle Speed ..... 119
- Mirrors  
   Automatic Dimming ..... 26  
   Automatic Dimming Rearview ..... 27  
   Folding ..... 25  
   Heated ..... 26  
   Interior Rearview ..... 26  
   Power ..... 25  
   Rear Camera ..... 27  
   Tilt in Reverse ..... 26
- Mode  
   Acceleration ..... 193  
   Car Wash ..... 184  
   Driver Control ..... 194  
   Monitor System, Tire Pressure ..... 320  
   Multi-band Antenna ..... 136  
   Multi-Point Vehicle Inspection (MPVI) ..... 360
- N**  
 Navigation  
   Connected Services ..... 383  
   Destination ..... 139  
   Symbols ..... 138  
   Using the System ..... 137
- New Vehicle Break-In ..... 180  
 Noise Control System ..... 301
- O**  
 Odometer ..... 97  
   Trip ..... 97  
 Off-Road  
   App ..... 170  
   Driving ..... 166  
   Recovery ..... 165  
 Older Children, Restraints ..... 62  
 One-Pedal Driving ..... 187  
 Online Account ..... 368  
 OnStar ..... 376  
   Additional Information ..... 380  
   Overview ..... 378  
 OnStar Emergency ..... 379  
 OnStar Security ..... 379
- Outlets  
   Power ..... 89  
 Overview ..... 130  
   Instrument Panel ..... 4  
 Owner Checks and Services ..... 360
- P**  
 Panel, Roof ..... 31  
 Park  
   Assist ..... 228, 237  
   Shifting Into ..... 182  
 Park (cont'd)  
   Shifting Out of ..... 183  
 Parking  
   Extended ..... 183  
 Parking Assist  
   Automatic ..... 238  
 Parking or Backing  
   Assistance Systems ..... 228  
 Passenger  
   Airbag Status Indicator ..... 101  
   Compartment Air Filter ..... 160  
   Sensing System ..... 57  
 Pedestrian Ahead Indicator ..... 105  
 Pedestrian Safety Signal ..... 87  
 Perchlorate Materials Requirements,  
   California ..... 291  
 Phone  
   Apple CarPlay and Android Auto ..... 147  
   Bluetooth ..... 142, 143  
 Plug-In Charging ..... 253  
 Port  
   USB ..... 136  
 Positioning  
   Vehicle ..... 140  
 Power  
   Button ..... 180  
   Door Locks ..... 14  
   Indicator Gauge ..... 99

Power (cont'd)

- Mirrors ..... 25
- Outlets ..... 89
- Protection, Battery ..... 128
- Retained Accessory (RAP) ..... 182
- Seat Adjustment ..... 39
- Windows ..... 29

Pregnancy, Using Seat Belts ..... 52

Privacy

- Vehicle Data Recording ..... 375

Problems with Route Guidance ..... 140

Program

- Courtesy Transportation ..... 371

Proposition 65 Warning

- California ..... 1
- Proposition 65 Warning, California ..... 344

Propulsion

- Power Messages ..... 118

Publication Ordering Information ..... 373

**R**

Radiator ..... 296

Radio

- AM-FM Radio ..... 134
- Frequency Statement ..... 374
- Reception ..... 136
- Satellite ..... 135

Reading Lamps ..... 127

Ready Indicator ..... 108

Rear

- Camera Mirror ..... 27
- Climate Control System ..... 158
- Cross Traffic Alert (RCTA) System ..... 242
- Heated Seats ..... 45
- Locking Axle ..... 199
- Pedestrian Alert ..... 242
- Seats ..... 44
- Storage ..... 83
- Vision Camera (RVC) ..... 229
- Windows ..... 30

Rearview Mirrors

- Automatic Dimming ..... 27

Reclining Seatbacks ..... 39

Recognition

- Voice ..... 141

Recommended Fluids and Lubricants ..... 361

Records

- Maintenance ..... 363

Recreational Vehicle Towing ..... 349

Regenerative Braking ..... 190

Reimbursement Program, GM

- Mobility ..... 369

Remote

- Key ..... 7
- Key Operation ..... 7

Remote (cont'd)

- Vehicle Start ..... 12

Replacement Parts

- Airbags ..... 62
- Maintenance ..... 362

Replacing

- Airbag System ..... 62
- LATCH System Parts After a Crash ..... 77
- Seat Belt System Parts after a Crash .... 53

Reporting Safety Defects

- Canadian Government ..... 375
- General Motors ..... 375
- U.S. Government ..... 374

Requirements

- Electrical Battery Charging ..... 262

Restraints

- Where to Put ..... 67

Retained Accessory Power (RAP) ..... 182

Reverse Automatic Braking ..... 240

Reverse Tilt Mirrors ..... 26

Ride Control Systems

- Air Suspension ..... 201

Roads

- Driving, Wet ..... 173

Roadside Assistance Program ..... 369

Roof

- Panel ..... 31
- Rack System ..... 84

Rotation, Tires .....	326		
<b>S</b>			
Safety			
Locks .....	15		
Pedestrian Signal .....	87		
Safety Defects Reporting			
Canadian Government .....	375		
General Motors .....	375		
U.S. Government .....	374		
Safety System Check .....	52		
Satellite Radio .....	135		
Scheduling Appointments .....	370		
Sealant Kit, Tire .....	333		
Seat Belts .....	46		
Buckle To Drive .....	47		
Care .....	52		
Extender .....	52		
How to Wear Seat Belts Properly .....	47		
Lap-Shoulder Belt .....	49		
Reminders .....	100		
Replacing after a Crash .....	53		
Use During Pregnancy .....	52		
Seats			
Head Restraints .....	37	Seats (cont'd)	
Heated and Ventilated, Front .....	43	Memory .....	40
Heated, Rear .....	45	Power Adjustment, Front .....	39
Lumbar Adjustment, Front .....	40	Rear .....	44
		Reclining Seatbacks .....	39
		Securing Child Restraints .....	77, 79
		Security	
		Light .....	108
		OnStar .....	379
		Vehicle .....	22
		Vehicle Alarm .....	23
		Service .....	160
		Accessories and Modifications .....	291
		Doing Your Own Work .....	291
		Electric Parking Brake Light .....	103
		Maintenance Records .....	363
		Maintenance, General Information .....	358
		Parts Identification .....	364
		Scheduling Appointments .....	370
		Vehicle Soon Light .....	102
		Servicing the Airbag .....	61
		Settings .....	148
		Shifting	
		Into Park .....	182
		Out of Park .....	183
		Side Blind Zone Alert (SBZA) .....	248
		Signals, Turn and Lane-Change .....	125
		Software Updates .....	134
		Specifications and Capacities .....	365
		Speedometer .....	97
		StabiliTrak	
		OFF Light .....	105
		Start Assist, Hill .....	190
		Start Vehicle, Remote .....	12
		Starting and Stopping the Vehicle .....	181
		Status	
		Charging Feedback .....	257
		Steering .....	164
		Column Lock .....	23
		Four-Wheel .....	196
		Heated Wheel .....	87
		Wheel Adjustment .....	87
		Wheel Controls .....	130
		Storage	
		Center Console .....	84
		Compartments .....	82
		Cupholders .....	82
		Glove Box .....	82
		Rear .....	83
		Roof Rack System .....	84
		Storage Areas	
		Underhood .....	83
		Storing the Tire Sealant and	
		Compressor Kit .....	338
		Stuck Vehicle .....	175
		Sun Visors .....	31

Super Cruise .....	213
Surround Vision System .....	229
Symbols .....	2
Navigation .....	138
System	
Airbag .....	53
Driver Assistance .....	227
Forward Collision Alert (FCA) .....	243
Global Positioning .....	140
Infotainment .....	377
Noise Control .....	301
Rear Cross Traffic Alert .....	242
Roof Rack .....	84
Surround Vision .....	229

**T**

Tailgate .....	19
Teen Driver .....	150
Text Telephone (TTY) Users .....	368
Theft-Deterrent Systems .....	24
Immobilizer .....	24
Time .....	89
Tires .....	314
All-Terrain .....	315
Buying New Tires .....	328
Chains .....	332
Changing .....	339
Designations .....	316

**Tires (cont'd)**

Different Size .....	329
Full-Size Spare .....	344
If a Tire Goes Flat .....	332
Inspection .....	326
Pressure .....	319
Pressure Light .....	107
Pressure Monitor Operation .....	321
Pressure Monitor System .....	320
Rotation .....	326
Sealant and Compressor Kit .....	333
Sealant and Compressor Kit, Storing .....	338
Sidewall Labeling .....	315
Terminology and Definitions .....	317
Uniform Tire Quality Grading .....	330
Wheel Alignment and Tire Balance .....	331
Wheel Replacement .....	331
When It Is Time for New Tires .....	327
Winter .....	315

**Towing**

App .....	279
Driving Characteristics .....	263
Equipment .....	270
General Information .....	262
Recreational Vehicle .....	349
Trailer .....	266
Trailer Sway Control (TSC) .....	278

**Traction**

Control System (TCS)/StabiliTrak Light .....	106
Control/Electronic Stability Control .....	191
Off Light .....	105
Trademarks and License Agreements .....	153
Trailer	
Sway Control (TSC) .....	278
Towing .....	266
Towing App .....	279
Transfer Case	
Four-Wheel Drive .....	188
Transportation Program, Courtesy .....	371
Transporting	
a Disabled Vehicle .....	347
Trip Odometer .....	97
Truck-Camper Loading Information .....	179
TTY Users	
Customer Assistance .....	368
Turn and Lane-Change Signals .....	125

**U****Underhood**

Compartment Fuse Block .....	305
Compartment Overview .....	295
Storage .....	83
Uniform Tire Quality Grading .....	330
Universal Remote System .....	119



Universal Remote System (cont'd)	
Operation .....	121
Programming .....	119
Updates	
Software .....	134
USB Port .....	136
Using	
Infotainment System .....	131
Navigation System .....	137
Utility Interruption of Charging .....	261
<b>V</b>	
Vehicle	
Ahead Indicator .....	105
Alarm System .....	23
Canadian Owners .....	2
Control .....	164
Data Recording and Privacy .....	375
Identification Number (VIN) .....	364
Load Limits .....	176
Messages .....	118
Positioning .....	140
Ready Light .....	108
Remote Start .....	12
Security .....	22
Service Soon Light .....	102
Speed Messages .....	119
Starting and Stopping .....	181

Vehicle (cont'd)	
Symbols .....	2
Vehicle Care	
Storing the Tire Sealant and Compressor Kit .....	338
Tire Pressure .....	319
Vehicle Security	
Steering Column Lock .....	23
Ventilation, Air .....	159
Visors .....	31
Voice Recognition .....	141
Voltage Devices and Wiring .....	303
<b>W</b>	
Warning	
Brake System Light .....	102
Caution and Danger .....	2
Hazard Flashers .....	125
Lights, Gauges, and Indicators .....	94
Washer Fluid .....	297
Wheels	
Alignment and Tire Balance .....	331
Different Size .....	329
Replacement .....	331
When It Is Time for New Tires .....	327
When to Charge .....	253
Where to Put the Restraint .....	67
Windows .....	29

Windows (cont'd)	
Power .....	29
Rear .....	30
Windshield	
Replacement .....	302
Wiper/Washer .....	88
Winter	
Driving .....	174
Tires .....	315
Wiper	
Blade Replacement .....	302
Wireless Charging .....	91
Wiring, High Voltage Devices .....	303

## Scan to Access

### United States



- Owner's Manuals
- Warranty Information
- Connected Services
- My GMC Rewards
- myGMC Mobile App
- How-To Videos
- Vehicle Diagnostics
- Scheduled Maintenance
- Vehicle Features
- Many Additional Resources

### Canada



---

### United States

Customer Assistance  
1-800-462-8782  
Roadside Assistance  
1-888-881-3302

### United States and Canada

Connected Services  
1-888-4-ONSTAR

### Canada

Customer Assistance  
1-800-263-3777  
Roadside Assistance  
1-800-268-6800



84867426 A

